

OSRAM GW KAGLB6.EM

Datasheet

Published by **ams-OSRAM AG**

Tobelbader Strasse 30, 8141 Premstaetten, Austria

Phone +43 3136 500-0

ams-osram.com

© All rights reserved



SOLERIQ™ S 15

GW KAGLB6.EM

The SOLERIQ™ S products were specifically designed for applications requiring large flux packages out of a compact area.

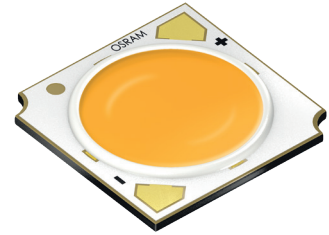

Applications

- Indoor lighting

Features

- Package: Chip-on-Board
- Typ. Radiation: 120° (Lambertian emitter)
- Color temperature: 2700K - 4000K
- CRI: 80 (min.)
- ESD: 2 kV acc. to ANSI/ESDA/JEDEC JS-001 (HBM, Class 2)
- Luminous Flux: typ. 2982 lm @ 3000 K, 85 °C
- Luminous efficacy: typ. 161 lm/W @ 3000 K, 85 °C

Ordering Information

Type	Color temperature	Luminous Flux ¹⁾ $I_F = 540 \text{ mA}$ Φ_v	Ordering Code
GW KAGLB6.EM-STTR-27S3	2700 K	2400 ... 3590 lm	Q65113A8268
GW KAGLB6.EM-SUTR-30S3	3000 K	2590 ... 3590 lm	Q65113A8267
GW KAGLB6.EM-TPTS-40S3	4000 K	2800 ... 3900 lm	Q65113A8266

Maximum Ratings

Parameter	Symbol		Values
Operating Temperature	T_{op}	min.	-40 °C
		max.	105 °C
Storage Temperature	T_{stg}	min.	-40 °C
		max.	105 °C
Junction Temperature	T_j	max.	125 °C
Forward Current $T_j = 85\text{ °C}$	I_F	min.	60 mA
		max.	1380 mA
Reverse voltage ²⁾	V_R		Not designed for reverse operation
ESD withstand voltage acc. to ANSI/ESDA/JEDEC JS-001 (HBM, Class 2)	V_{ESD}		2 kV

Characteristics

$I_F = 540 \text{ mA}$; $T_J = 85 \text{ °C}$

Parameter	Symbol		Values
Viewing angle at 50% I_V	2ϕ	typ.	120 °
Forward Voltage ³⁾⁴⁾ $I_F = 540 \text{ mA}$	V_F	min. typ. max.	32.00 V 34.30 V 40.00 V
Reverse current ²⁾	I_R		Not designed for reverse operation
Color Rendering Index ⁵⁾	CRI	min.	80
Electrical thermal resistance junction/solderpoint with efficiency $\eta_e = 46 \%$	$R_{thJS \text{ elec.}}$	typ.	0.33 K / W

Brightness Groups

Group	Luminous Flux ¹⁾ I _F = 540 mA min. Φ _V	Luminous Flux ¹⁾ I _F = 540 mA max. Φ _V
ST	2400 lm	2590 lm
SU	2590 lm	2800 lm
TP	2800 lm	3040 lm
TQ	3040 lm	3300 lm
TR	3300 lm	3590 lm
TS	3590 lm	3900 lm

Chromaticity Coordinate Groups ⁶⁾

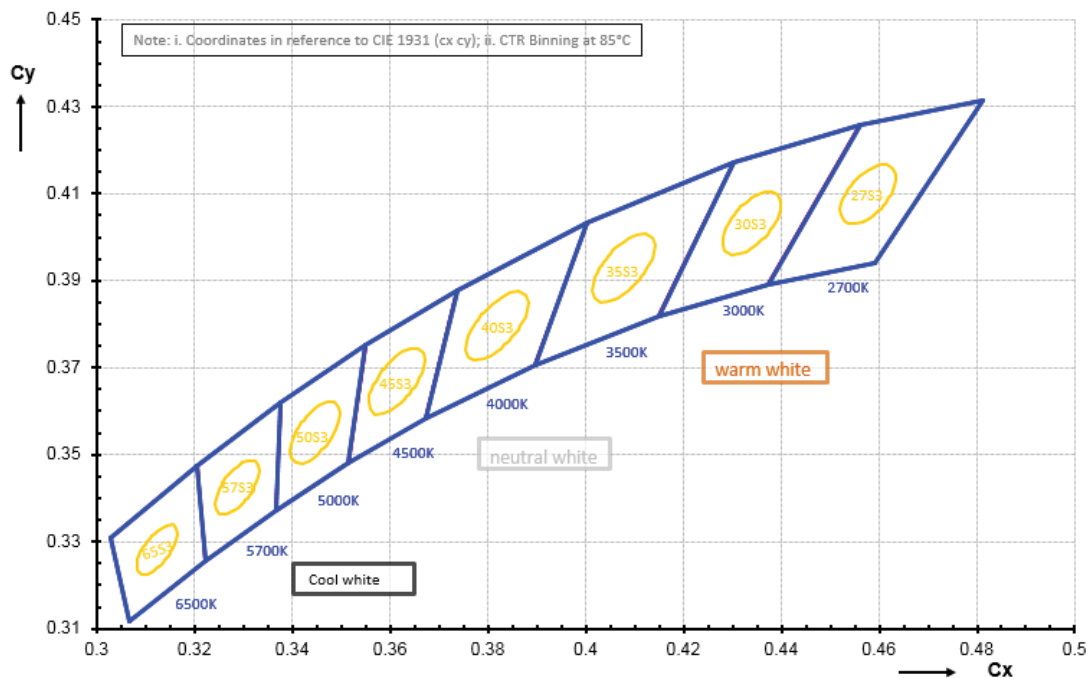

Chromaticity Coordinate Groups

CCT	Center Cx	Center Cy	a	b	∅
2700 K	0.4577	0.4098	0.008	0.0041	54.1
3000 K	0.4339	0.4032	0.0086	0.0042	53.7
4000 K	0.3818	0.3796	0.0094	0.0041	53.4

Relative Spectral Emission ⁷⁾

$\Phi_{rel} = f(\lambda)$; $I_F = 540 \text{ mA}$; $T_J = 85 \text{ }^\circ\text{C}$

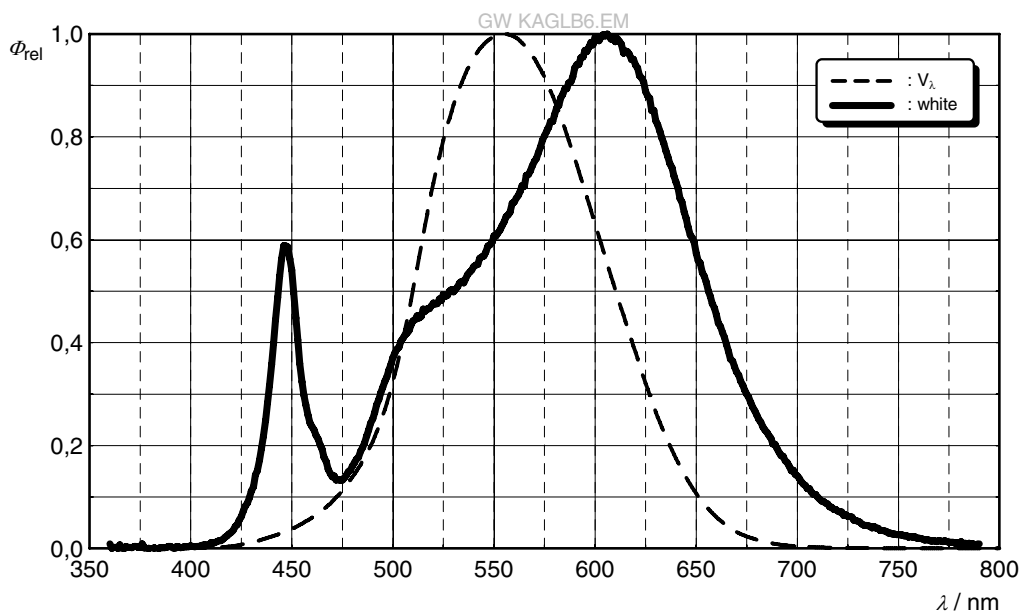

Radiation Characteristics ⁷⁾

$I_{rel} = f(\varphi)$; $T_J = 85 \text{ }^\circ\text{C}$

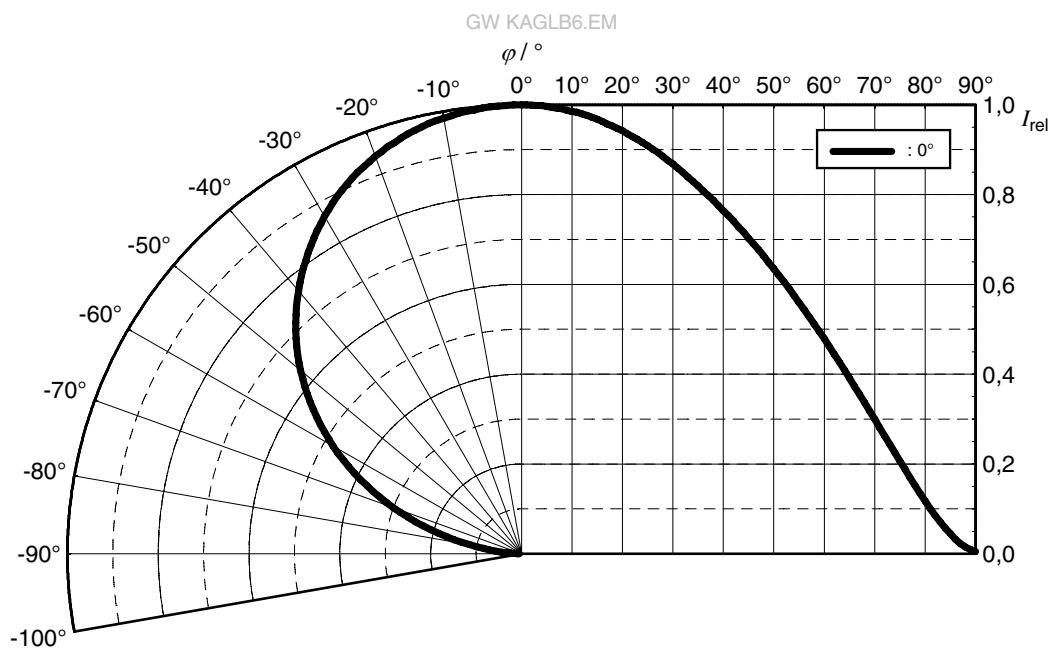

Forward current 7)

$I_F = f(V_F); T_J = 85\text{ °C}$

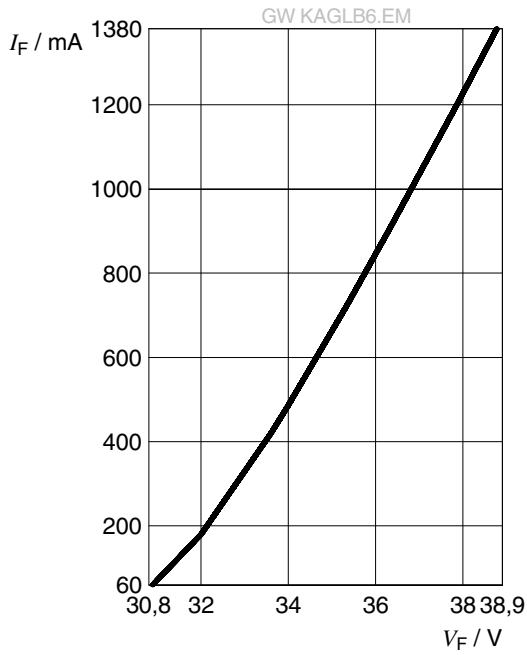

Relative Luminous Flux 7), 8)

$\Phi_V / \Phi_V(540\text{ mA}) = f(I_F); T_J = 85\text{ °C}$

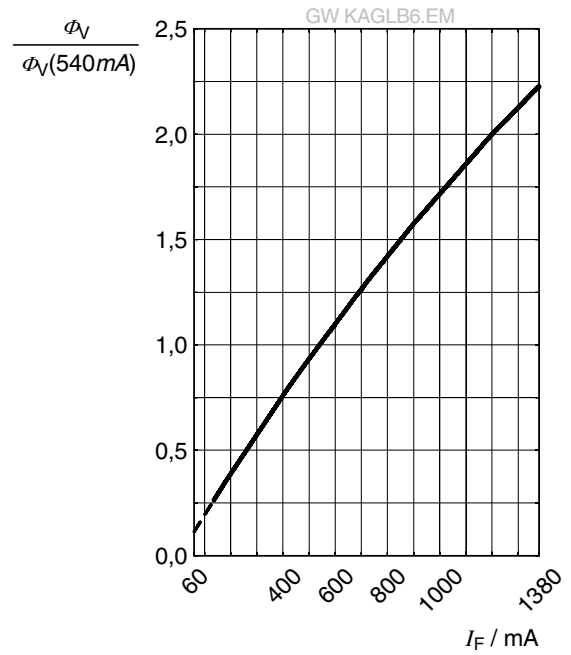

Chromaticity Coordinate Shift 7)

$\Delta Cx, \Delta Cy = f(I_F); T_J = 85\text{ °C}$

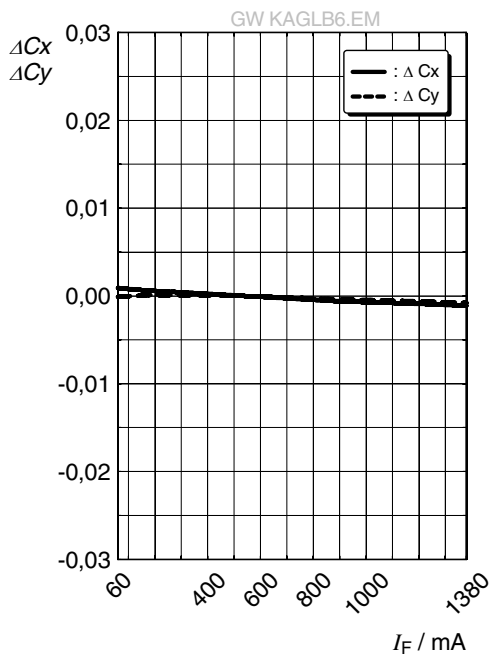

Forward Voltage ⁷⁾

$$\Delta V_F = V_F - V_F(85^\circ\text{C}) = f(T_j); I_F = 540\text{ mA}$$

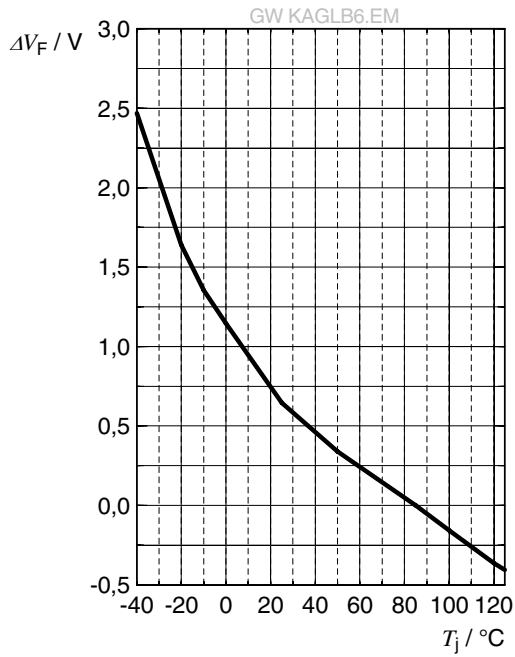

Relative Luminous Flux ⁷⁾

$$\Phi_V / \Phi_V(85^\circ\text{C}) = f(T_j); I_F = 540\text{ mA}$$

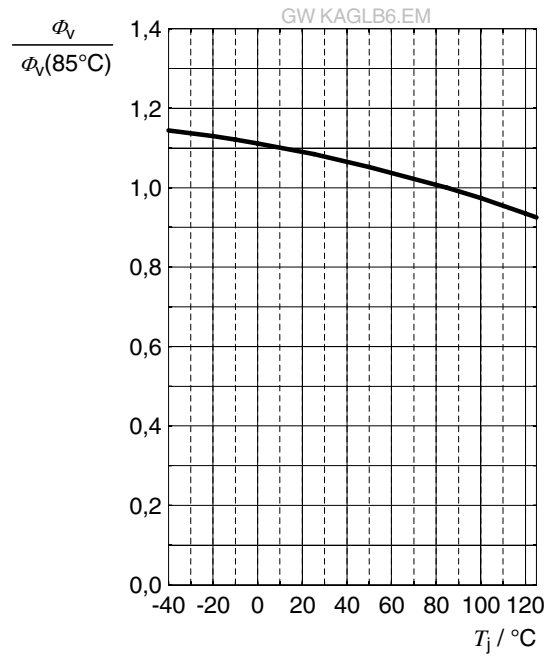

Chromaticity Coordinate Shift ⁷⁾

$$\Delta C_x, \Delta C_y = f(T_j); I_F = 540\text{ mA}$$

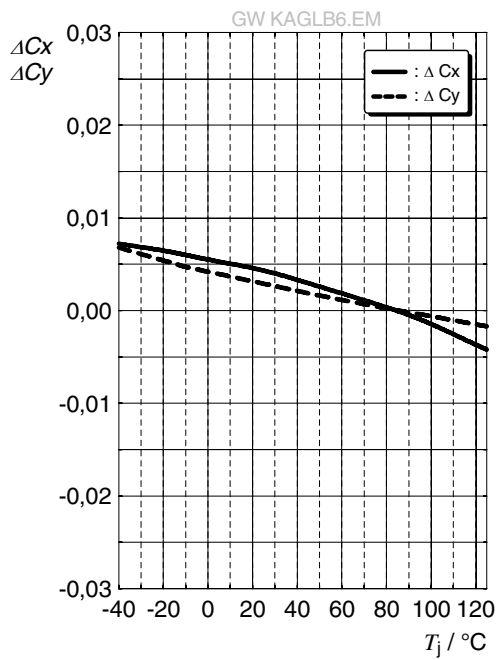

Max. Permissible Forward Current ⁹⁾

$$I_F = f(T)$$

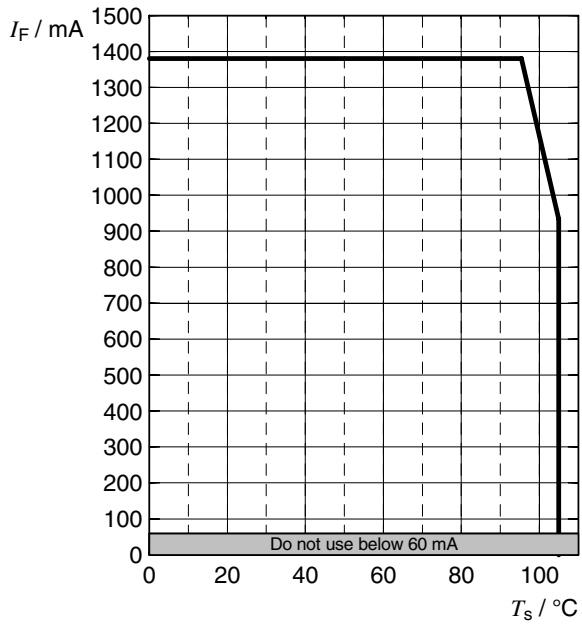

Dimensional Drawing ¹⁰⁾

Marking on backside of COB device

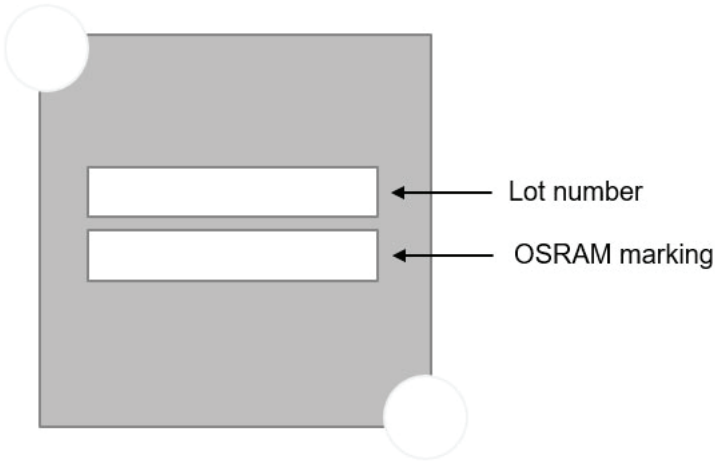

Marking Nomenclature

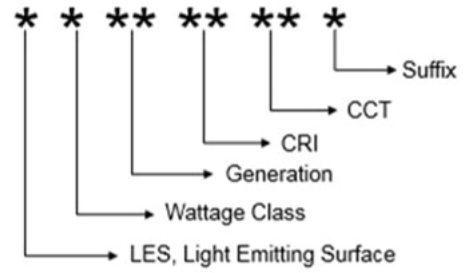

Dimensional Drawing ¹⁰⁾

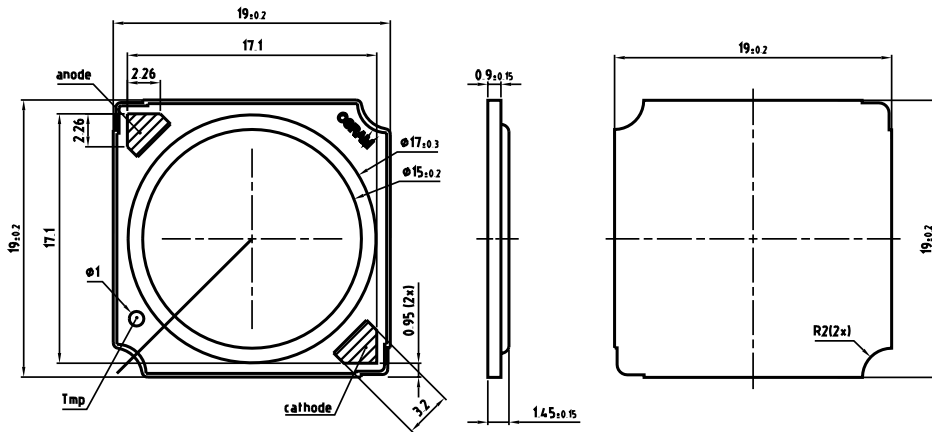

general tolerance ± 0.1
lead finish Au

C67062-A0326-A1-02

Further Information:

Approximate Weight: 1,007.1 mg

Tray ¹⁰⁾

25 pieces per tray

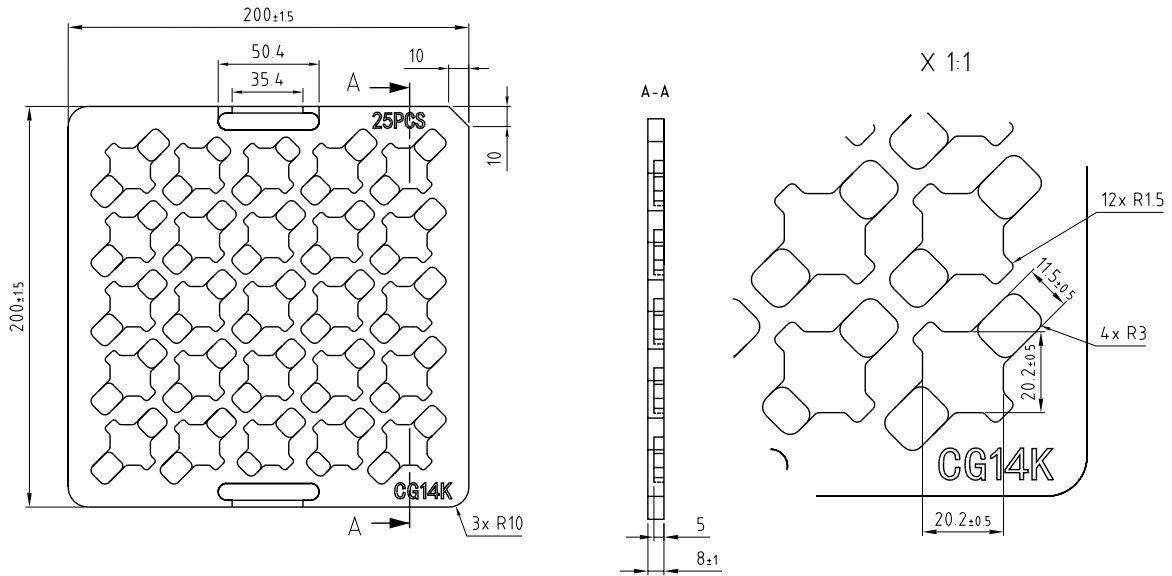

C67062-A0362-X1-02

Barcode-Product-Label (BPL)



OSRAM LX XXXX BIN1: XX-XX-X-XXX-X

RoHS Compliant

(6P) BATCH NO: 1234567890

(1T) LOT NO: 1234567890 (9D) D/C: 1234

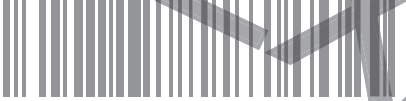
(X) PROD NO: 123456789 (Q) QTY: 9999 (G) GROUP: XX-XX-X-X



ML Temp ST
X XXX °C X

Pack: RXX
DEMY XXX
X_X123_1234.1234 X



OHA04563

Notes

The evaluation of eye safety occurs according to the standard IEC 62471:2006 (photo biological safety of lamps and lamp systems). Within the risk grouping system of this IEC standard, the device specified in this data sheet fall into the class **moderate risk (exposure time 0.25 s)**. Under real circumstances (for exposure time, conditions of the eye pupils, observation distance), it is assumed that no endangerment to the eye exists from these devices. As a matter of principle, however, it should be mentioned that intense light sources have a high secondary exposure potential due to their blinding effect. When looking at bright light sources (e.g. headlights), temporary reduction in visual acuity and afterimages can occur, leading to irritation, annoyance, visual impairment, and even accidents, depending on the situation.

Subcomponents of this device contain, in addition to other substances, metal filled materials including silver. Metal filled materials can be affected by environments that contain traces of aggressive substances. Therefore, we recommend that customers minimize device exposure to aggressive substances during storage, production, and use. Devices that showed visible discoloration when tested using the described tests above did show no performance deviations within failure limits during the stated test duration. Respective failure limits are described in the IEC60810.

This device is designed for specific/recommended applications only. Please consult OSRAM Opto Semiconductors Sales Staff in advance for detailed information on other non-recommended applications (e.g. automotive).

Change management for this component is aligned with the requirements of the lighting market.

For further application related information please visit <https://ams-osram.com/support/application-notes>

Disclaimer

Attention please!

The information describes the type of component and shall not be considered as assured characteristics. Terms of delivery and rights to change design reserved. Due to technical requirements components may contain dangerous substances.

For information on the types in question please contact our Sales Organization.

If printed or downloaded, please find the latest version on our website.

Packing

Please use the recycling operators known to you. We can also help you – get in touch with your nearest sales office. By agreement we will take packing material back, if it is sorted. You must bear the costs of transport. For packing material that is returned to us unsorted or which we are not obliged to accept, we shall have to invoice you for any costs incurred.

Product and functional safety devices/applications or medical devices/applications

Our components are not developed, constructed or tested for the application as safety relevant component or for the application in medical devices.

Our products are not qualified at module and system level for such application.

In case buyer – or customer supplied by buyer – considers using our components in product safety devices/ applications or medical devices/applications, buyer and/or customer has to inform our local sales partner immediately and we and buyer and /or customer will analyze and coordinate the customer-specific request between us and buyer and/or customer.

Glossary

- 1) **Brightness:** Brightness values are measured during a current pulse of typically 10 ms, with a tolerance of +/- 7%.
- 2) **Reverse Operation:** Not designed for reverse operation. Continuous reverse operation can cause migration and damage of the device.
- 3) **Forward Voltage:** The Forward voltage is measured during a current pulse duration of typically 1 ms with a tolerance of $\pm 0.05V$.
- 4) **Forward Voltage:** Forward voltages are tested at a current pulse duration of 1 ms and a tolerance of $\pm 0.05 V$ and an expanded uncertainty of $\pm 0.1 V$ (acc. to GUM with a coverage factor of $k = 3$).
- 5) **Color reproduction index:** Color reproduction index values (CRI-RA) are measured during a current pulse of typically 10 ms and with a tolerance of ± 2 .
- 6) **Chromaticity coordinate groups:** Chromaticity coordinate groups are measured during a current pulse duration of typically 10ms with a tolerance of ± 0.005 .
- 7) **Typical Values:** Due to the special conditions of the manufacturing processes of semiconductor devices, the typical data or calculated correlations of technical parameters can only reflect statistical figures. These do not necessarily correspond to the actual parameters of each single product, which could differ from the typical data and calculated correlations or the typical characteristic line. If requested, e.g. because of technical improvements, these typ. data will be changed without any further notice.
- 8) **Characteristic curve:** In the range where the line of the graph is broken, you must expect higher differences between single devices within one packing unit.
- 9) **Thermal Resistance:** $R_{th\ max}$ is based on statistic values (6σ) used for Derating.
- 10) **Tolerance of Measure:** Unless otherwise noted in drawing, tolerances are specified with ± 0.1 and dimensions are specified in mm.

Revision History

Version	Date	Change
1.0	2024-03-28	Initial Version
1.1	2025-05-05	Dimensional Drawing
1.2	2026-04-23	Certificate Logo



EU RoHS and China RoHS compliant product

此产品符合欧盟 RoHS 指令的要求；
按照中国的相关法规和标准，
不含有毒有害物质或元素。

Published by ams-OSRAM AG

Tobelbader Strasse 30, 8141 Premstaetten, Austria

Phone +43 3136 500-0

ams-osram.com

© All rights reserved

am 

OSRAM