

OSRAM V105Q121A-850

Datasheet

Not for new design

Published by **ams-OSRAM AG**

Tobelbader Strasse 30, 8141 Premstaetten, Austria

Phone +43 3136 500-0

ams-osram.com

© All rights reserved



BIDOS™ P2433 Q

V105Q121A-850

850 nm Multi-Mode VCSEL Power Array
Designed for Sensor Field of Interest : 60° x 45°

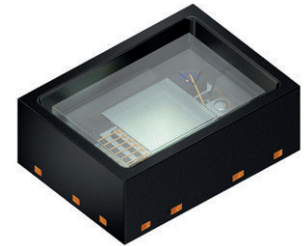

Applications

- Access control & security

Features

- Package: QFN Package
- ESD: 2 kV acc. to ANSI/ESDA/JEDEC JS-001 (HBM, Class 2)
- Very small SMT package
- VCSEL power array
- High optical power
- IR Laser with photodiode

Ordering Information

| Type | Optical output power typ. P_{opt} | Ordering Code |
|---------------|---|---------------|
| V105Q121A-850 | 3 W | Q65113A5438 |

Depending on the mode of operation, these devices emit highly concentrated visible and non-visible light which can be hazardous to the human eye. Products which incorporate these devices must follow the safety precautions given in the “Notes” section.

Maximum Ratings

$T_A = 25\text{ °C}$

| Parameter | Symbol | | Values |
|---|----------------|------|------------------------------------|
| Operating temperature (refers to T_A ; $T_A = 85\text{ °C}$ with reduced efficiency) | T_{op} | min. | -20 °C |
| | | max. | 85 °C |
| Storage temperature | T_{stg} | min. | -40 °C |
| | | max. | 100 °C |
| Soldering temperature $t_{max} = 10\text{ s}$ | T_s | max. | 260 °C |
| ESD withstand voltage acc. to ANSI/ESDA/JEDEC JS-001 (HBM, Class 2) | V_{ESD} | max. | 2 kV |
| IR Laser | | | |
| Junction temperature | T_j | max. | 125 °C |
| Forward current pulsed $t_p \leq 500\text{ }\mu\text{s}$; $D = 0.01$ | $I_{F\ pulse}$ | max. | 6 A |
| Reverse voltage ⁵⁾ | V_R | | Not designed for reverse operation |
| Photodiode | | | |
| Reverse voltage ⁵⁾ | V_R | max. | 20 V |
| Breakdown voltage | V_{BR} | min. | 50 V |

Stresses beyond those listed under Absolute Maximum Ratings may cause permanent damage to the device.

Characteristics

$t_p = 300 \mu\text{s}$; $D = 0.05$; $T_A = 25 \text{ }^\circ\text{C}$

| Parameter | Symbol | | Values |
|---|-------------------------|----------------------|----------------------------|
| IR Laser | | | |
| Peak wavelength ⁶⁾ | λ_{peak} | min. typ. max. | 840 nm 850 nm 860 nm |
| Optical output power ⁷⁾ $I_F = 4 \text{ A}$ | P_{opt} | min. typ. | 2.4 W 3.00 W |
| Field of view (HFOV) Angle at Ee,50% level, normalized to the centroid | Θ_{\parallel} | typ. | 63 ° |
| Field of view (VFOV) Angle at Ee,50% level, normalized to the centroid | Θ_{\perp} | typ. | 50 ° |
| Dimensions of chip area | $L \times W$ | typ. | 0.9 x 1.0 mm x mm |
| Slope efficiency | η | typ. | 0.95 W/ A |
| Power conversion efficiency $I_F = 4 \text{ A}$ | η_{tot} | typ. | 38 % |
| Threshold current | I_{th} | typ. max. | 0.9 A 1.5 A |
| Forward voltage ⁸⁾ $I_F = 4 \text{ A}$ | V_F | min. typ. max. | 1.90 V 2.10 V 2.45 V |
| Rise time 10% and 90% of $I_{e \text{ max}}$ | t_r | typ. | 1 ns |
| Fall time 10% and 90% of $I_{e \text{ max}}$ | t_f | typ. | 1 ns |
| Temperature coefficient of wavelength | TC_{λ} | typ. | 0.06 nm/ K |
| Thermal resistance junction solder point real $t_p = 0.01 \text{ s}$ | $R_{\text{thJS real}}$ | max. | 11 K/ W |

Characteristics

$T_A = 25\text{ °C}$

| Parameter | Symbol | | Values |
|---|--------------------|--------------|------------------------|
| Photodiode | | | |
| Wavelength of max sensitivity | $\lambda_{S\ max}$ | typ. | 800 nm |
| Spectral range of sensitivity | $\lambda_{10\%}$ | typ. | 450 ... 1050 nm |
| Photocurrent $\lambda = 850\text{ nm}$, $E_e = 0.5\text{ mW/cm}^2$, $V_R = 3.3\text{ V}$ | I_P | typ. | 0.25 μA |
| Photocurrent ⁹⁾ with VCSEL @ $I_F = 4\text{ A}$; $\lambda = 850\text{ nm}$; $V_R = 3.3\text{ V}$ | I_P | typ. | 0.50 mA |
| Dimensions of chip area | L x W | typ. | 0.38 x 0.38 mm x mm |
| Dark current $V_R = 3.3\text{ V}$, $E = 0$ | I_R | typ. max. | 0.1 nA 30 nA |
| Open-circuit voltage $\lambda = 850\text{ nm}$, $E_e = 0.5\text{ mW/cm}^2$ | V_O | typ. | 320 mV |
| Short-circuit current $\lambda = 850\text{ nm}$, $E_e = 0.5\text{ mW/cm}^2$, $V_R = 0\text{ V}$ | I_{SC} | typ. | 235 nA |
| Rise time 10 %/ 90%; $\lambda = 850\text{ nm}$ | t_r | typ. | 1 ns |
| Fall time 10 %/ 90%; $\lambda = 850\text{ nm}$ | t_f | typ. | 1 ns |
| Forward voltage $I_F = 10\text{ mA}$, $E = 0$ | V_F | typ. max. | 0.85 V 1.00 V |
| Capacitance $E_e = 0\text{ mW/cm}^2$, $f = 1\text{ MHz}$, $V_R = 0\text{ V}$ | C_0 | typ. | 2 pF |
| Temperature coefficient of sensitivity $\lambda = 940\text{ nm}$, $E_e = 0.5\text{ mW/cm}^2$, $V_R = 3.3\text{ V}$ | TC_i | typ. | 0.23 %/ K |

Relative Spectral Emission ^{1), 2)}

- infrared (850 nm): $I_{e,rel} = f(\lambda)$; $I_F = 4000 \text{ mA}$; $t_p = 300 \mu\text{s}$

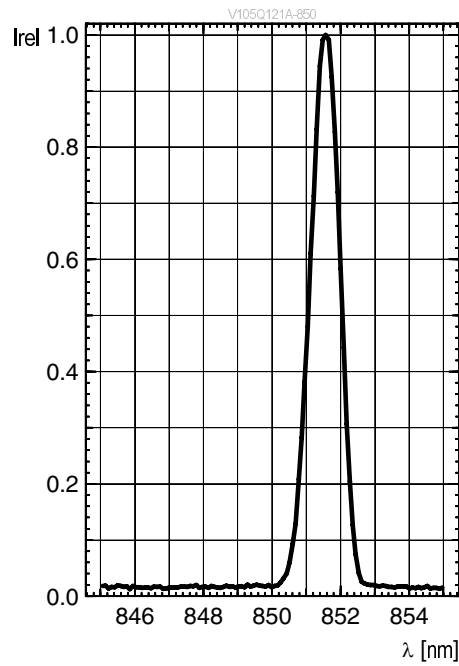

Radiation Characteristics ^{1), 2)}

- infrared (850 nm): $E_{e,rel} = f(\phi)$; $I_F = 4000 \text{ mA}$; $t_p = 300 \mu\text{s}$; $D = 0.05$

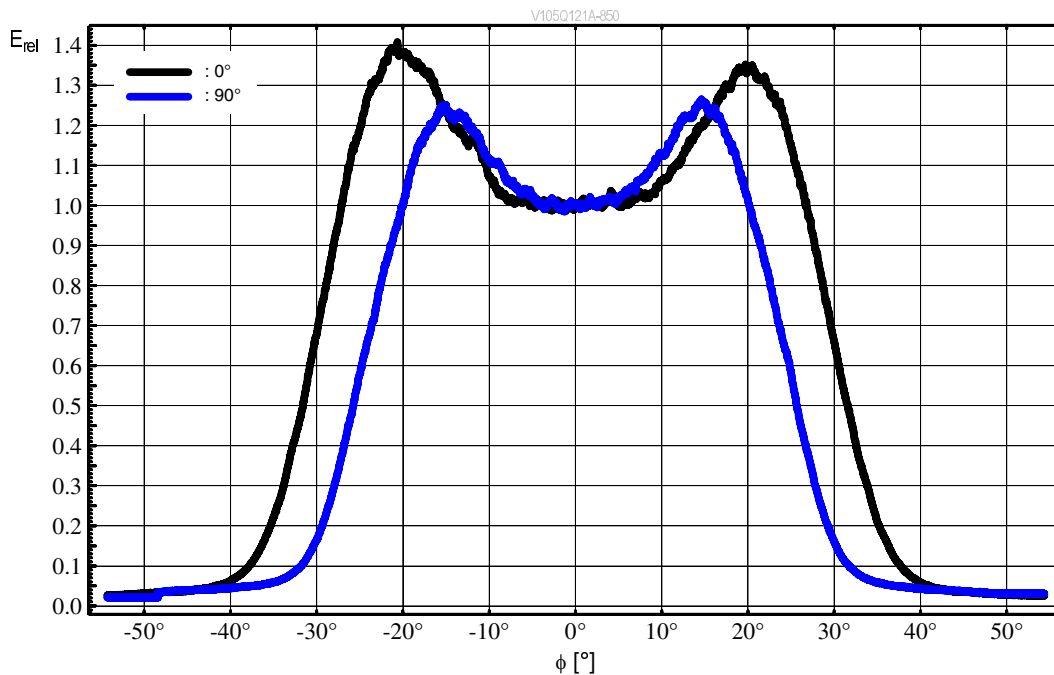

Not for new design

Far-Field Illumination Pattern ²⁾

- infrared (850 nm): $I_{e,rel} = f(\varphi)$; $I_F = 4000 \text{ mA}$; $t_p = 300 \text{ }\mu\text{s}$; $D = 0.05$

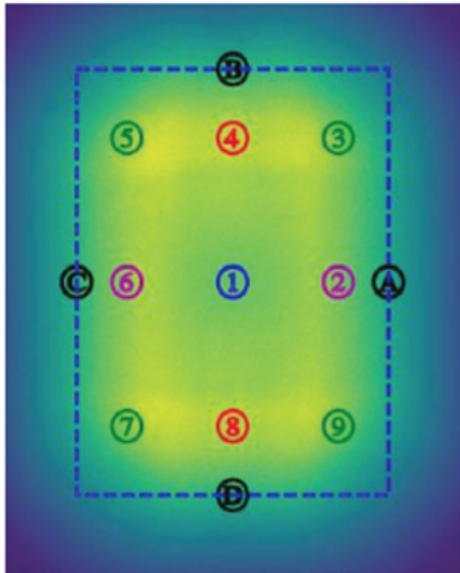

Sensor FOI 60°(H) x 45°(V) (dotted line)

| | Min | Typ | Max |
|---|------|------|------|
| 1 | 100% | 100% | 100% |
| 2 | 100% | 120% | 140% |
| 3 | 110% | 135% | 160% |
| 4 | 110% | 133% | 155% |
| 5 | 110% | 135% | 160% |
| 6 | 100% | 120% | 140% |
| 7 | 110% | 135% | 160% |
| 8 | 110% | 133% | 155% |
| 9 | 110% | 135% | 160% |
| A | 65% | 85% | 105% |
| B | 70% | 90% | 110% |
| C | 65% | 85% | 105% |
| D | 70% | 90% | 110% |

Relative Spectral Sensitivity ^{1), 2)}

■ photodiode: $S_{rel} = f(\lambda)$

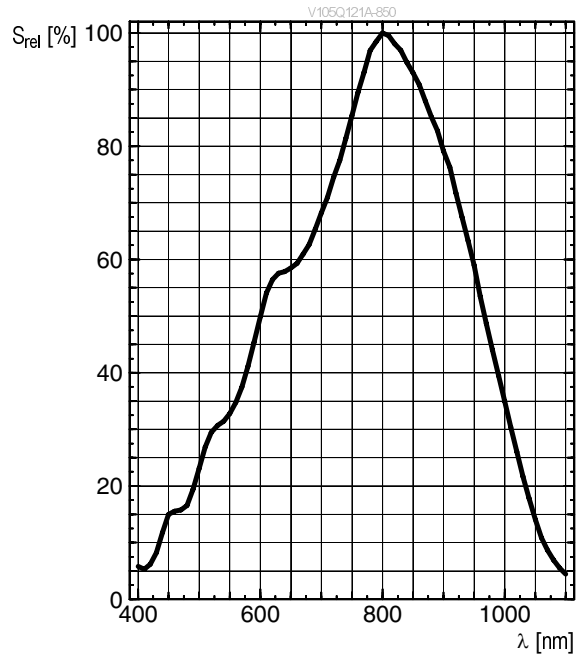

Optical Output Power ^{1), 2)}

• infrared (850 nm): $P_{opt} = f(I_F)$; $t_p = 300 \mu s$; $D = 0.05$

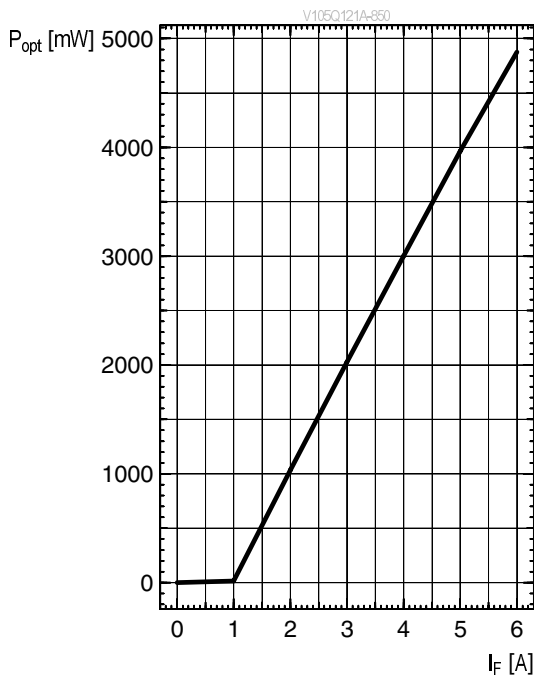

Forward Voltage ^{1), 2)}

• infrared (850 nm): $V_F = f(I_F)$; $t_p = 300 \mu s$; $D = 0.05$

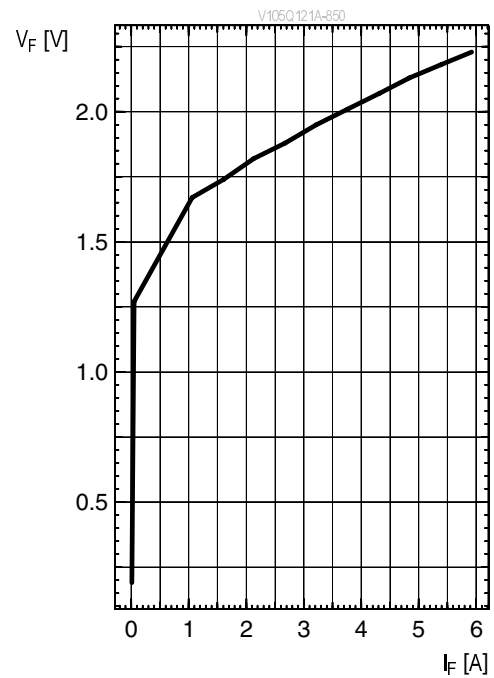

Not for new design

Photocurrent 1), 2)

■ photodiode: $I_p = f(P_{opt}); V_R = 3.3\text{ V}$

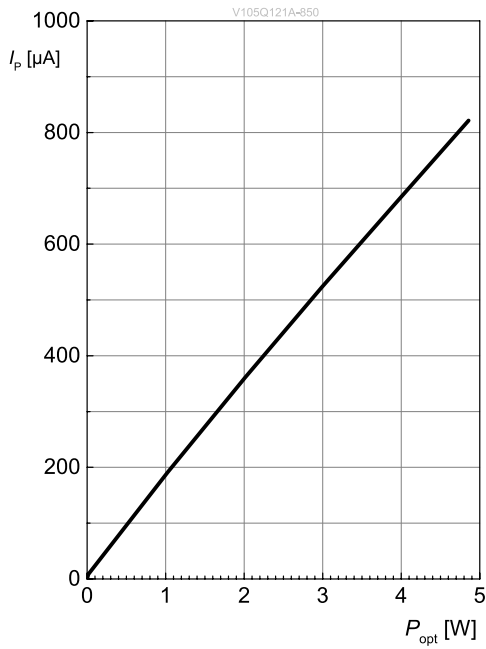

Dark Current 1), 2)

■ photodiode: $I_R = f(V_R)$

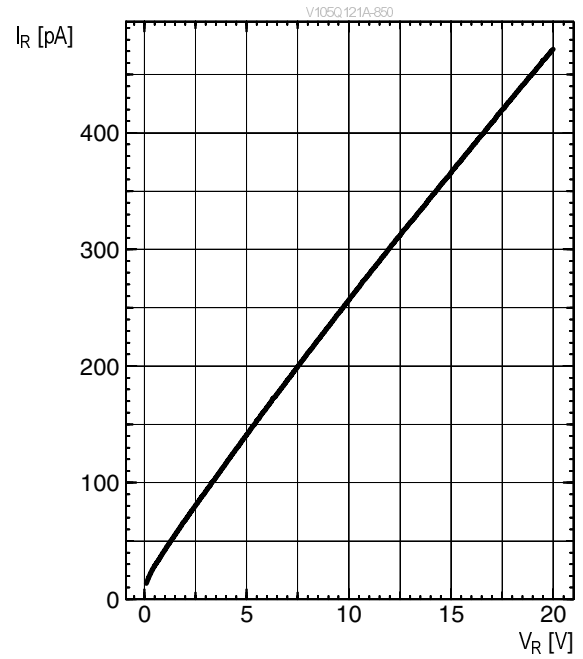

Capacitance 1), 2)

■ photodiode: $C = f(V_R)$

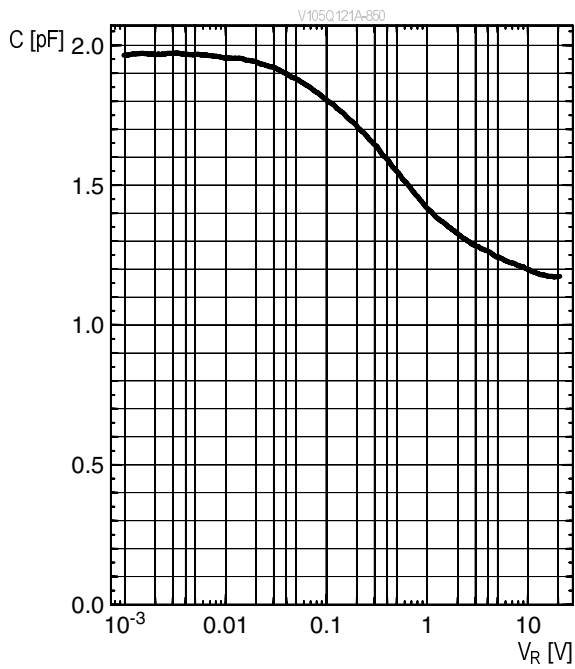

Not for new design

Permissible Pulse Handling Capability

• infrared (850 nm): $I_F = f(t_p)$; $D = \text{param.}$; $T_A = 25\text{ °C}$

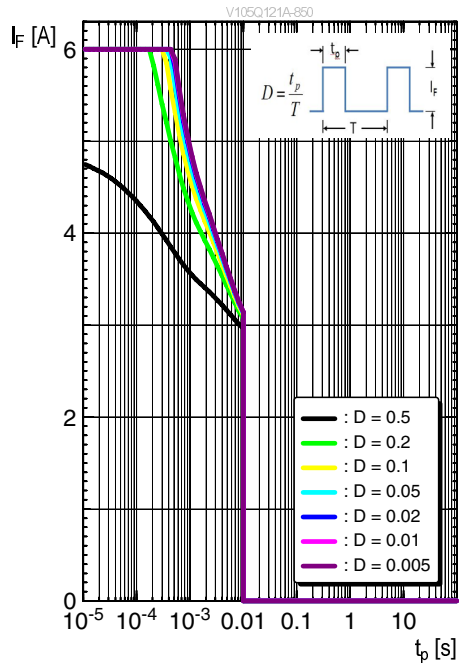

Permissible Pulse Handling Capability

• infrared (850 nm): $I_F = f(t_p)$; $D = \text{param.}$; $T_A = 85\text{ °C}$

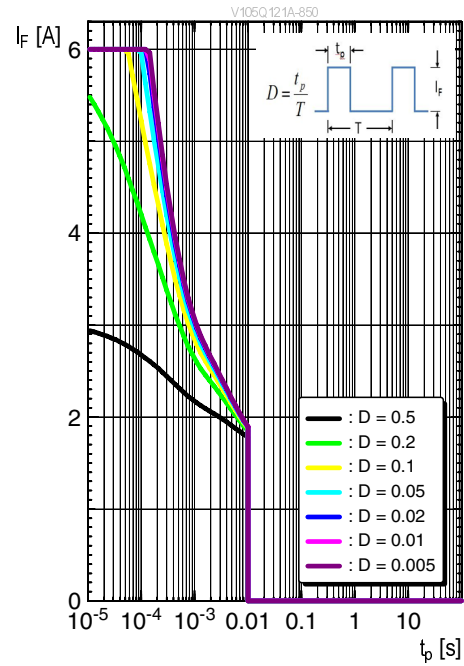

Dimensional Drawing ³⁾

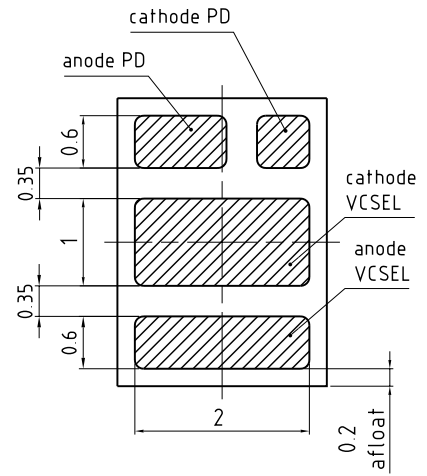
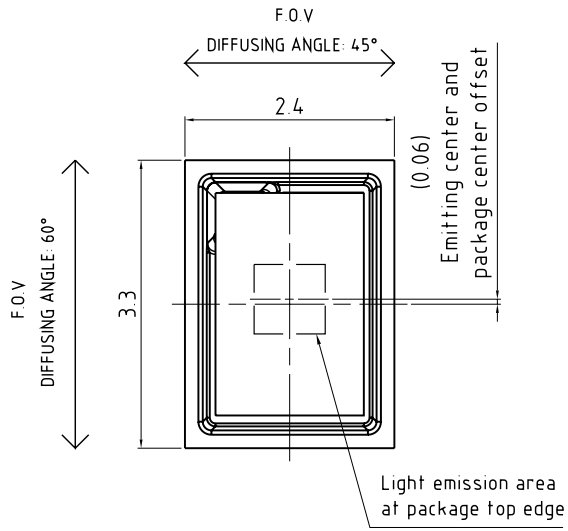

general tolerance ± 0.1

lead finish Au 

C67062-A0363-A1-06

Further Information:

Approximate Weight: 20.0 mg

Recommended Solder Pad ³⁾

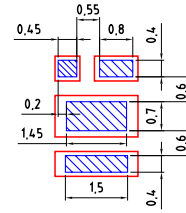
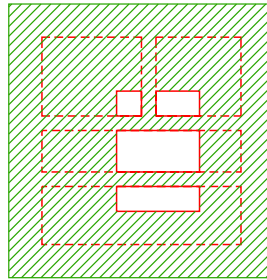
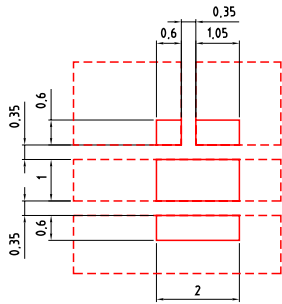

Component Location on Pad

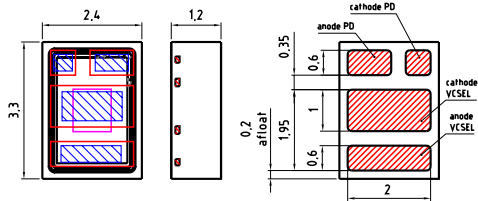

E062.3010.294-03

Reflow Soldering Profile

Product complies to MSL Level 3 acc. to JEDEC J-STD-020E

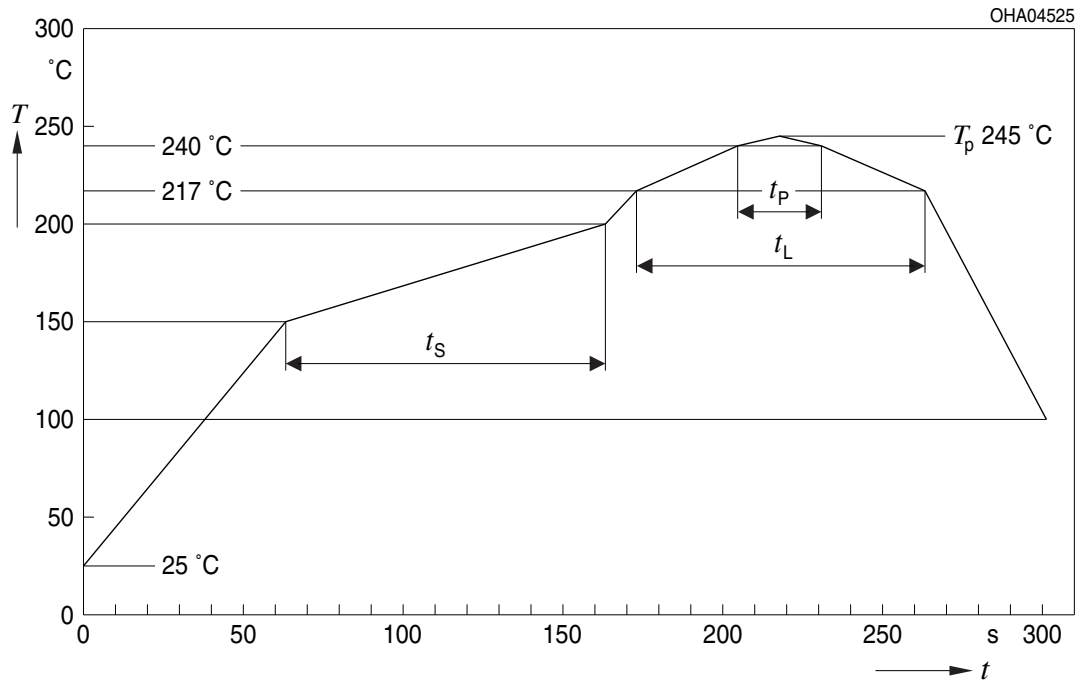

| Profile Feature | Symbol | Pb-Free (SnAgCu) Assembly | | | Unit |
|---|--------|---------------------------|----------------|---------|------|
| | | Minimum | Recommendation | Maximum | |
| Ramp-up rate to preheat ^{*)} 25 °C to 150 °C | | | 2 | 3 | K/s |
| Time t_s T_{Smin} to T_{Smax} | t_s | 60 | 100 | 120 | s |
| Ramp-up rate to peak ^{*)} T_{Smax} to T_p | | | 2 | 3 | K/s |
| Liquidus temperature | T_L | | 217 | | °C |
| Time above liquidus temperature | t_L | | 80 | 100 | s |
| Peak temperature | T_p | | 245 | 260 | °C |
| Time within 5 °C of the specified peak temperature $T_p - 5$ K | t_p | 10 | 20 | 30 | s |
| Ramp-down rate* T_p to 100 °C | | | 3 | 6 | K/s |
| Time 25 °C to T_p | | | | 480 | s |

All temperatures refer to the center of the package, measured on the top of the component

* slope calculation DT/Dt : Dt max. 5 s; fulfillment for the whole T-range

Taping ³⁾

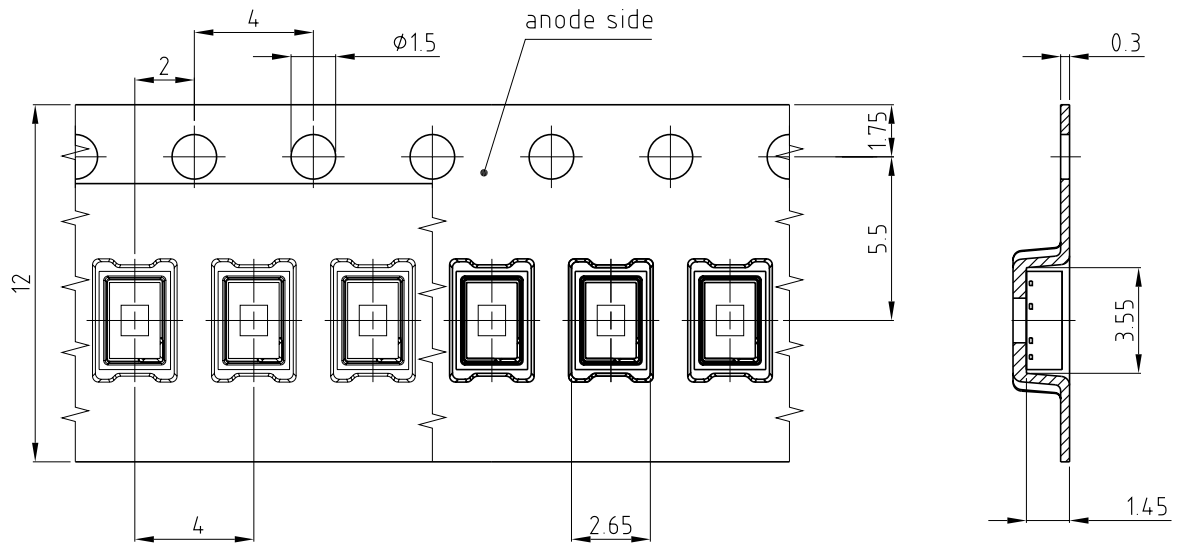

C67062-A0363-B6-04

Tape and Reel ⁴⁾

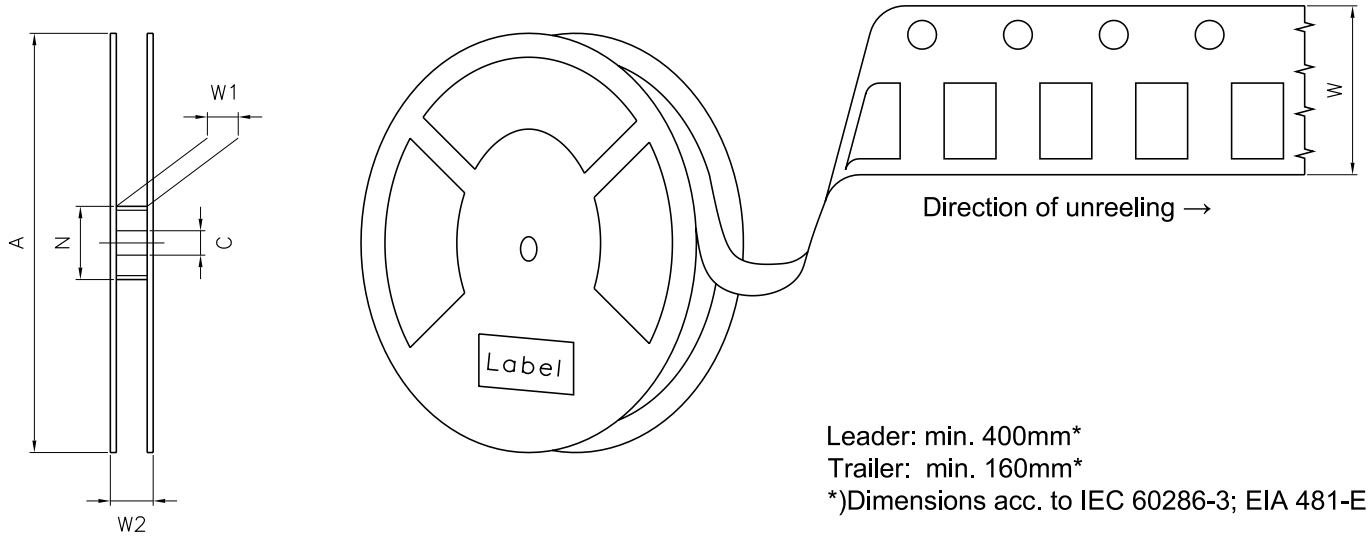

Reel Dimensions

| A | W | N _{min} | W ₁ | W _{2max} | Pieces per PU |
|--------|---------------------|------------------|----------------|-------------------|---------------|
| 180 mm | 12 + 0.3 / - 0.1 mm | 60 mm | 12.4 + 2 mm | 18.4 mm | 2000 |

Barcode-Product-Label (BPL)

OSRAM LX XXXX BIN1: XX-XX-X-XXX-X

RoHS Compliant

(6P) BATCH NO: 1234567890 ML Temp ST
X XXX °C X

(1T) LOT NO: 1234567890 (9D) D/C: 1234

Pack: RXX
DEMY XXX
X_X123_1234.1234 X

(X) PROD NO: 123456789(Q)QTY: 9999 (G) GROUP: XX-XX-X-X

OHA04563

Dry Packing Process and Materials

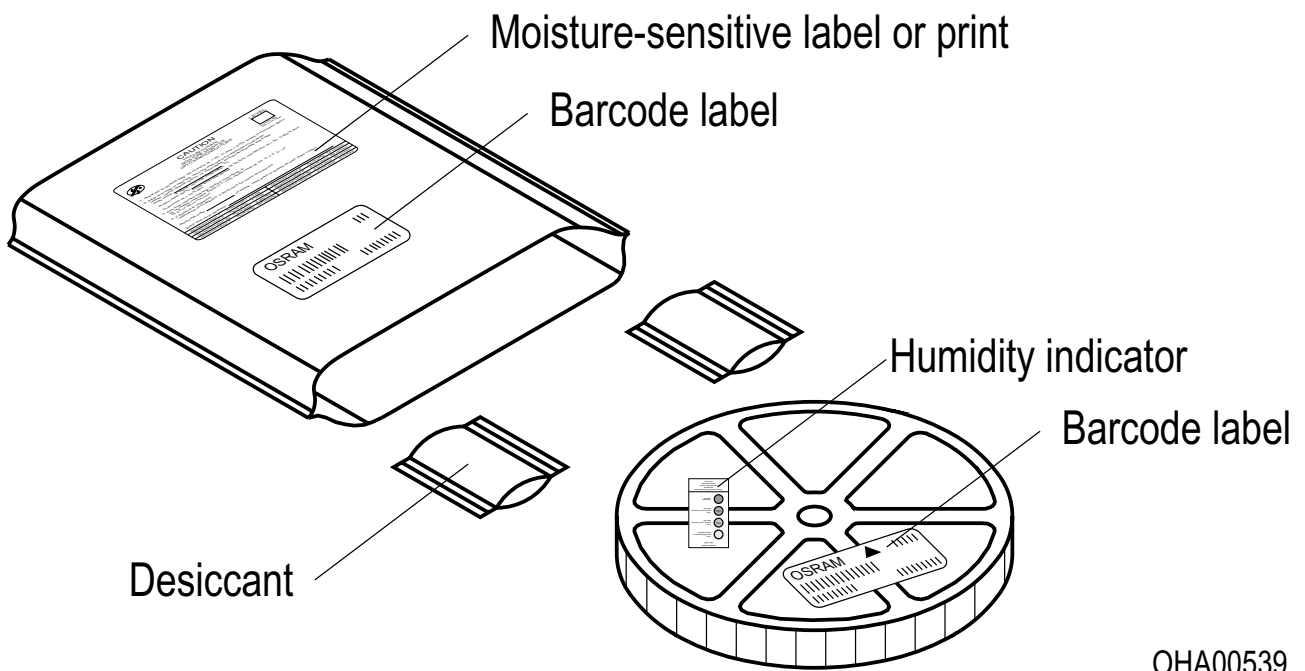

OHA00539

Not for new design

Notes

Depending on the mode of operation, these devices emit highly concentrated visible and non visible light which can be hazardous to the human eye. Products which incorporate these devices have to follow the safety precautions given in IEC 60825-1.

Subcomponents of this device contain, in addition to other substances, metal filled materials including silver. Metal filled materials can be affected by environments that contain traces of aggressive substances. Therefore, we recommend that customers minimize device exposure to aggressive substances during storage, production, and use. Devices that showed visible discoloration when tested using the described tests above did show no performance deviations within failure limits during the stated test duration. Respective failure limits are described in the IEC60810.

For further application related information please visit <https://ams-osram.com/support/application-notes>

Disclaimer

Attention please!

The information describes the type of component and shall not be considered as assured characteristics. Terms of delivery and rights to change design reserved. Due to technical requirements components may contain dangerous substances.

For information on the types in question please contact our Sales Organization.

If printed or downloaded, please find the latest version on our website.

Packing

Please use the recycling operators known to you. We can also help you – get in touch with your nearest sales office. By agreement we will take packing material back, if it is sorted. You must bear the costs of transport. For packing material that is returned to us unsorted or which we are not obliged to accept, we shall have to invoice you for any costs incurred.

Product and functional safety devices/applications or medical devices/applications

Our components are not developed, constructed or tested for the application as safety relevant component or for the application in medical devices.

Our products are not qualified at module and system level for such application.

In case buyer – or customer supplied by buyer – considers using our components in product safety devices/ applications or medical devices/applications, buyer and/or customer has to inform our local sales partner immediately and we and buyer and /or customer will analyze and coordinate the customer-specific request between us and buyer and/or customer.

Glossary

- 1) **Typical Values:** Due to the special conditions of the manufacturing processes of semiconductor devices, the typical data or calculated correlations of technical parameters can only reflect statistical figures. These do not necessarily correspond to the actual parameters of each single product, which could differ from the typical data and calculated correlations or the typical characteristic line. If requested, e.g. because of technical improvements, these typ. data will be changed without any further notice.
- 2) **Testing temperature:** $T_A = 25^\circ\text{C}$ (unless otherwise specified)
- 3) **Tolerance of Measure:** Unless otherwise noted in drawing, tolerances are specified with ± 0.1 and dimensions are specified in mm.
- 4) **Tape and Reel:** All dimensions and tolerances are specified acc. IEC 60286-3 and specified in mm.
- 5) **Reverse Operation:** This product is intended to be operated by applying a forward current within the specified range. Applying any continuous reverse bias or forward bias below the voltage range of light emission shall be avoided because it may cause migration which can change the electro-optical characteristics or damage the LED.
- 6) **Wavelength:** The wavelengths are measured with a tolerance of ± 1 nm.
- 7) **Optical Power:** The optical power values are measured with a tolerance of $\pm 11\%$.
- 8) **Forward Voltage:** The forward voltages are measured with a tolerance of ± 0.1 V.
- 9) **Photocurrent:** The photocurrent values are measured (by irradiating the devices with a homogenous light source and applying a voltage to the device) with a tolerance of $\pm 11\%$.

Revision History

| Version | Date | Change |
|---------|------------|-------------------------------|
| 1.0 | 2023-11-23 | Initial Version |
| 1.1 | 2024-06-26 | Recommended Solder Pad Taping |
| 1.2 | 2025-02-04 | Characteristics |
| 1.3 | 2025-05-28 | Brand |
| 1.4 | 2025-10-01 | Characteristics Glossary |
| 1.5 | 2026-06-03 | Not for new design |

Not for new design



EU RoHS and China RoHS compliant product

此产品符合欧盟 RoHS 指令的要求；
按照中国的相关法规和标准，
不含有毒有害物质或元素。

Published by ams-OSRAM AG

Tobelbader Strasse 30, 8141 Premstaetten, Austria

Phone +43 3136 500-0

ams-osram.com

© All rights reserved

am 

OSRAM