

OSRAM SFH 4725CS A01

Datasheet

Published by **ams-OSRAM AG**

Tobelbader Strasse 30, 8141 Premstaetten, Austria

Phone +43 3136 500-0

ams-osram.com

© All rights reserved



OSLON™ Black

SFH 4725CS A01

OSLON Black Series (940 nm) - 80 °

High power infrared LED for In-Cabin Sensing applications like driver monitoring, occupant monitoring, interior monitoring, gesture sensing and child presence detection.

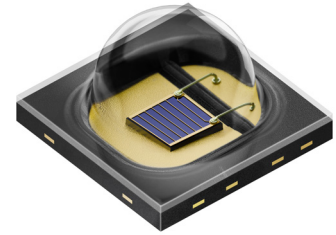

Applications

- Access control & security
- Authentication
- Exterior sensing for ADAS
- Eye, face and hand tracking
- In-Cabin sensing

Features

- Package: clear silicone lens
- Qualifications: AEC-Q102 Qualified
- ESD: 8 kV acc. to ANSI/ESDA/JEDEC JS-001 (HBM, Class 3B)
- IR lightsource with high efficiency
- Double stack emitter
- Low thermal resistance
- Optimized for high current pulse operation
- Centroid Wavelength: typ. 940nm
- Visual Appearance: Reduced red glow

Ordering Information

Type	Radiant intensity ¹⁾²⁾ $I_F = 1 \text{ A}; t_p = 10 \text{ ms}$ I_e	Radiant intensity ¹⁾ typ. $I_F = 1 \text{ A}; t_p = 10 \text{ ms}$ I_e	Ordering Code
SFH 4725CS A01-EA2EB2	800 ... 1120 mW/sr	920 mW/sr	Q65115A2816

Maximum Ratings

$T_s = 25\text{ °C}$

Parameter	Symbol		Values
Operating temperature	T_{op}	min.	-40 °C
		max.	125 °C
Storage temperature	T_{stg}	min.	-40 °C
		max.	125 °C
Junction temperature	T_j	max.	165 °C
Forward current	I_F	min.	20 mA
		max.	1500 mA
Forward current pulsed $t_p \leq 7\text{ ms}; D \leq 0.005$	$I_{F\text{ pulse}}$	max.	5000 mA
Reverse current ³⁾	I_R	max.	200 mA
ESD withstand voltage acc. to ANSI/ESDA/JEDEC JS-001 (HBM, Class 3B)	V_{ESD}	max.	8 kV

For the forward current and power consumption please see “maximum permissible forward current” diagram.

Characteristics

$I_F = 1000 \text{ mA}$; $t_p = 10 \text{ ms}$; $T_s = 25 \text{ °C}$

Parameter	Symbol		Values
Peak wavelength ⁴⁾	λ_{peak}	min. typ. max.	935 nm 950 nm 965 nm
Centroid wavelength ⁴⁾	$\lambda_{\text{centroid}}$	min. typ. max.	928 nm 940 nm 952 nm
Spectral bandwidth at 50% $I_{e,\text{rel,max}}$ ⁴⁾	$\Delta\lambda$	min. typ. max.	24 nm 34 nm 44 nm
Half angle	φ	typ.	40 °
Dimensions of active chip area	L x W	typ.	1 x 1 mm x mm
Rise time (10% / 90%) $I_F = 5 \text{ A}$; $R_L = 50 \text{ }\Omega$	t_r	typ.	10 ns
Fall time (10% / 90%) $I_F = 5 \text{ A}$; $R_L = 50 \text{ }\Omega$	t_f	typ.	11 ns
Forward voltage ⁵⁾ $I_F = 1 \text{ A}$; $t_p = 100 \text{ }\mu\text{s}$	V_F	min. typ. max.	2.45 V 2.68 V 2.95 V
Forward voltage ⁵⁾ $I_F = 1.5 \text{ A}$; $t_p = 100 \text{ }\mu\text{s}$	V_F	min. typ. max.	2.55 V 2.75 V 3.35 V
Forward voltage ⁵⁾ $I_F = 5 \text{ A}$; $t_p = 100 \text{ }\mu\text{s}$	V_F	min. typ. max.	2.9 V 3.25 V 3.85 V
Reverse voltage ³⁾ $I_R = 20 \text{ mA}$	V_R	max.	1.2 V
Reverse voltage (ESD device) ³⁾	$V_{R\text{ESD}}$	min.	5 V
Radiant intensity ¹⁾ $I_F = 1.5 \text{ A}$; $t_p = 100 \text{ }\mu\text{s}$	I_e	typ.	1350 mW/sr
Radiant intensity ¹⁾ $I_F = 5 \text{ A}$; $t_p = 100 \text{ }\mu\text{s}$	I_e	typ.	3750 mW/sr
Total radiant flux ⁶⁾ $I_F = 1 \text{ A}$; $t_p = 100 \text{ }\mu\text{s}$	Φ_e	typ.	1710 mW
Total radiant flux ⁶⁾ $I_F = 1.5 \text{ A}$; $t_p = 100 \text{ }\mu\text{s}$	Φ_e	typ.	2500 mW

Characteristics

$I_F = 1000 \text{ mA}$; $t_p = 10 \text{ ms}$; $T_s = 25 \text{ °C}$

Parameter	Symbol		Values
Total radiant flux ⁶⁾ $I_F = 5 \text{ A}$; $t_p = 100 \text{ }\mu\text{s}$	Φ_e	typ.	6980 mW
Thermal resistance junction solder point electrical ⁷⁾ with efficiency $\eta_e = 64 \text{ %}$	$R_{\text{thJS elec.}}$	typ. max.	1.6 K / W 1.9 K / W
Thermal resistance junction solder point real ⁷⁾	$R_{\text{thJS real}}$	typ. max.	4.5 K / W 5.3 K / W

Brightness Groups

Group	Radiant intensity ¹⁾²⁾ $I_F = 1 \text{ A}; t_p = 10 \text{ ms}$ min.	Radiant intensity ¹⁾²⁾ $I_F = 1 \text{ A}; t_p = 10 \text{ ms}$ max.
	I_e	I_e
EA2	800 mW/sr	900 mW/sr
EB1	900 mW/sr	1000 mW/sr
EB2	1000 mW/sr	1120 mW/sr

Only one group in one packing unit.

Relative Spectral Emission ^{8), 9)}

$$I_{e,rel} = f(\lambda); I_F = 1000 \text{ mA}; t_p = 10 \text{ ms}$$

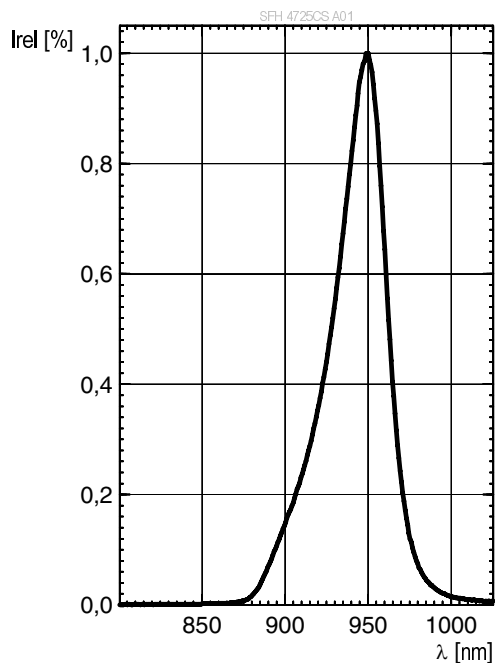

Radiation Characteristics ^{8), 9)}

$$I_{e,rel} = f(\varphi)$$

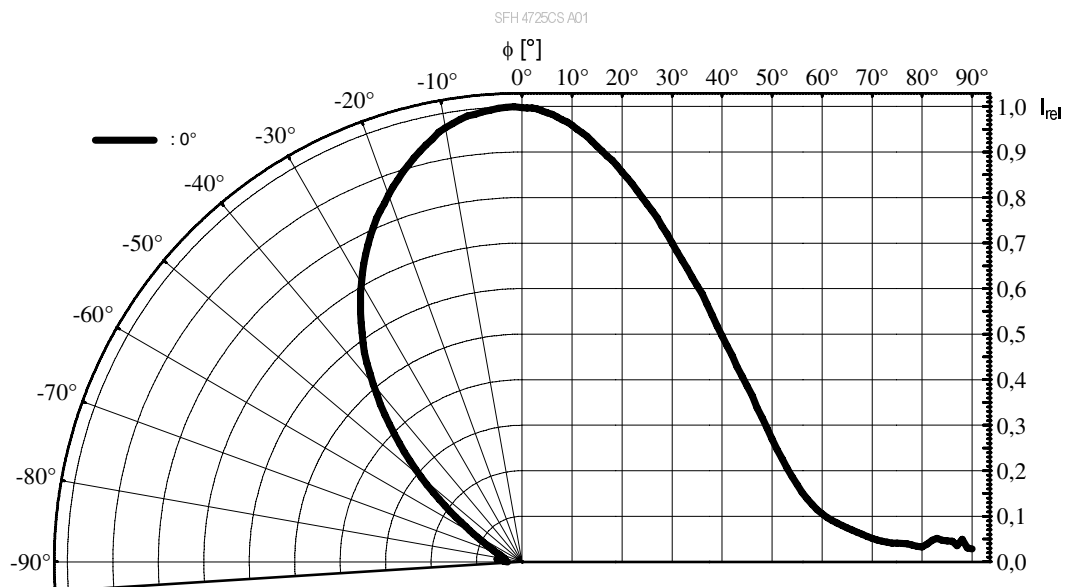

Forward current 8), 9)

$I_F = f(V_F)$; single pulse; $t_p = 100 \mu s$

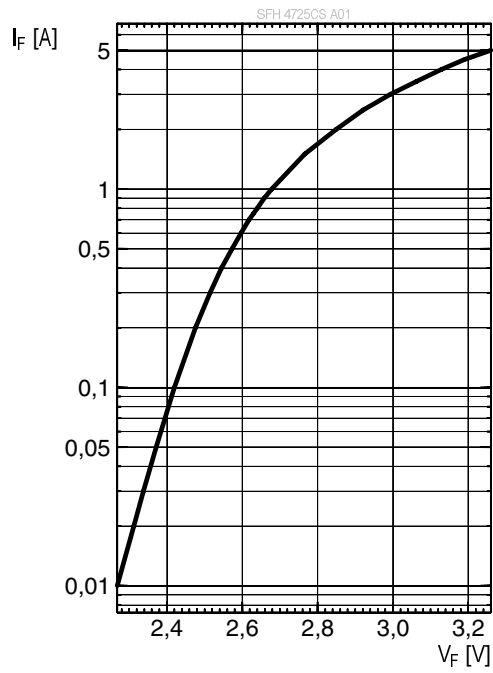

Relative Total Radiant Flux 8), 9)

$\Phi_e / \Phi_e(1000mA) = f(I_F)$; single pulse; $t_p = 100 \mu s$

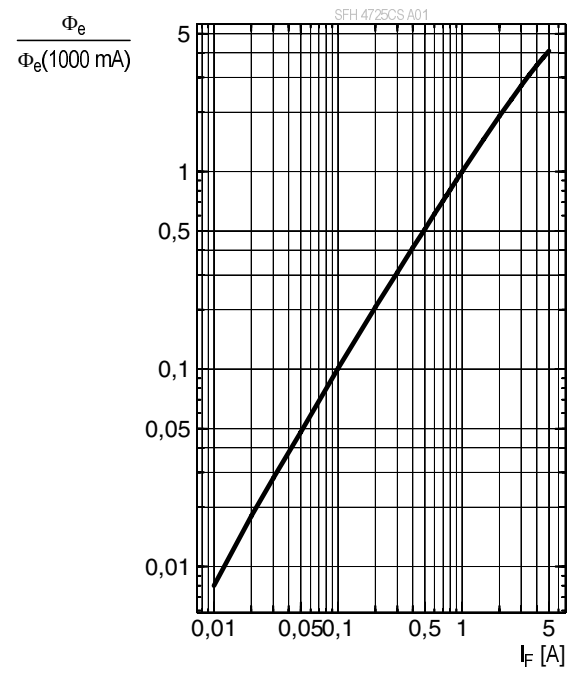

Forward Voltage ⁸⁾

$V_F = f(T_S); I_F = 1A; t_p = 100\mu s; \text{single pulse}$

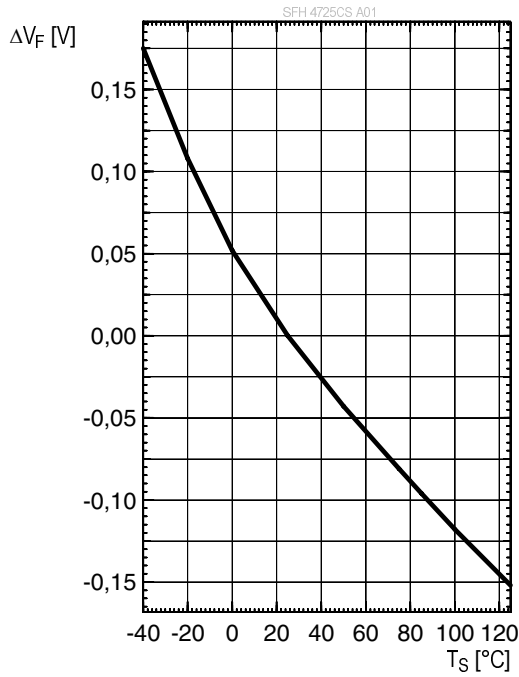

Relative Total Radiant Flux ⁸⁾

$\Phi_{rel} = f(T_S); I_F = 1A; t_p = 100\mu s; \text{single pulse}$

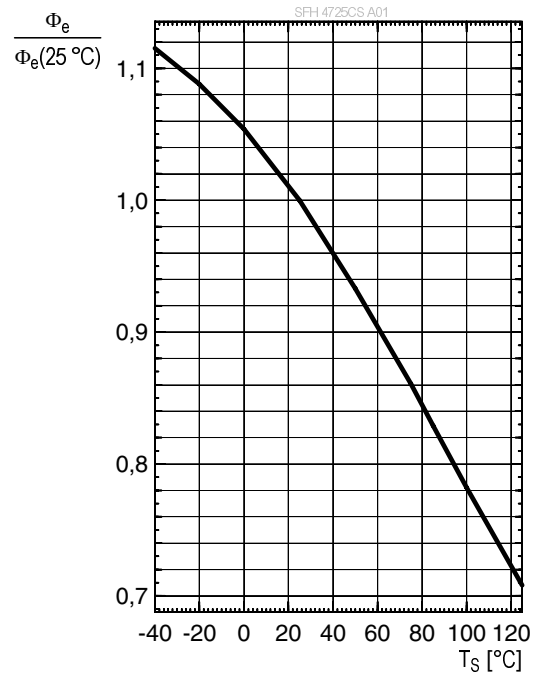

Centroid Wavelength ⁸⁾

$\lambda_{centroid} = f(T_S); I_F = 1A; t_p = 100\mu s; \text{single pulse}$

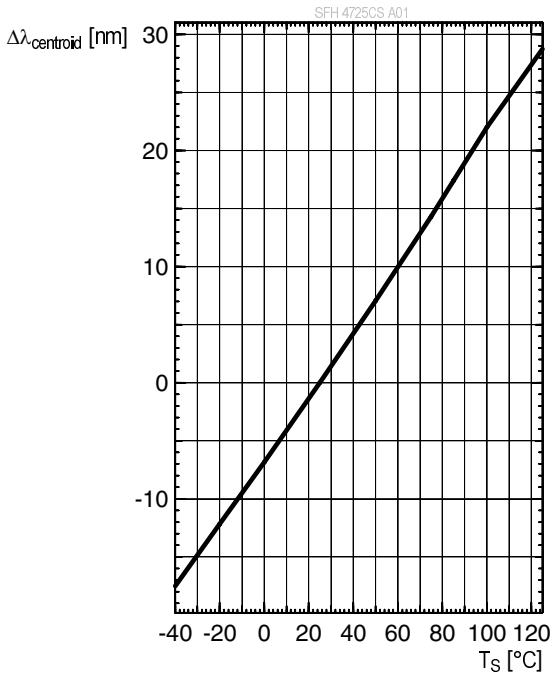

Max. Permissible Forward Current

$$I_{F_max} = f(D, T_s); t_p \leq 10\text{ms}$$

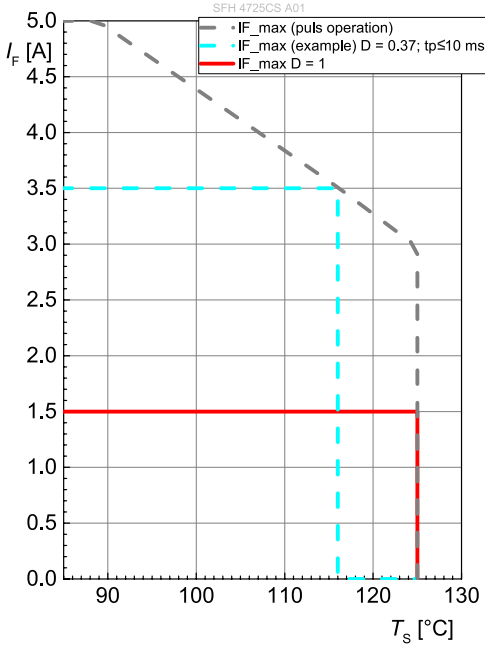

Max. Permissible Forward Current

$$I_{F_max} = f(D, T_s); t_p \leq 10\text{ms}$$

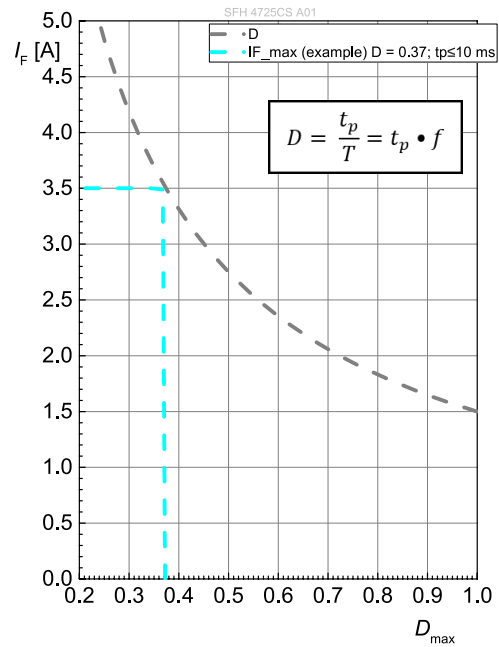

Permissible Pulse Handling Capability

$$I_F = f(t_p); D = \text{parameter}; T_s \leq 95^\circ\text{C}$$

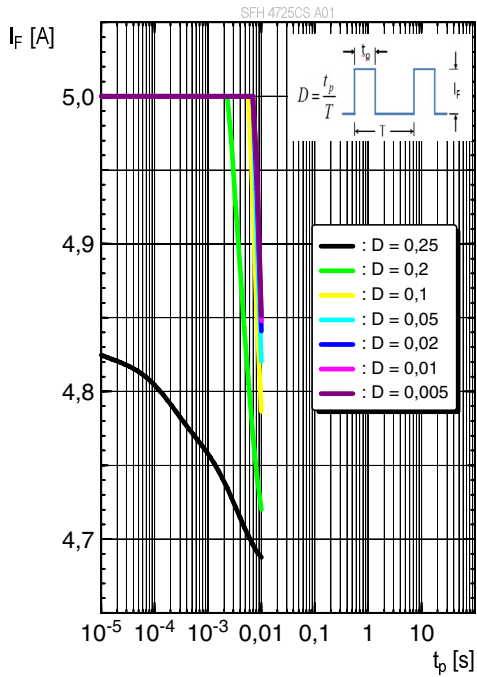

Permissible Pulse Handling Capability

$$I_F = f(t_p); D = \text{parameter}; T_s \leq 105^\circ\text{C}$$

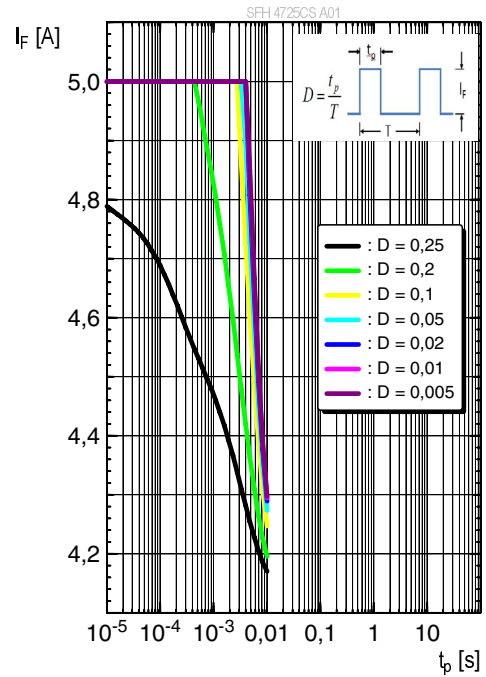

Permissible Pulse Handling Capability

$I_F = f(t_p)$; $D = \text{parameter}$; $T_s \leq 125\text{ }^\circ\text{C}$

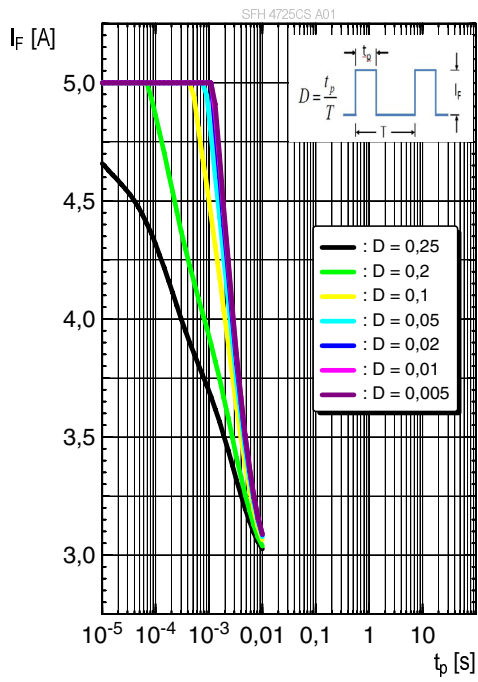

Dimensional Drawing ¹⁰⁾

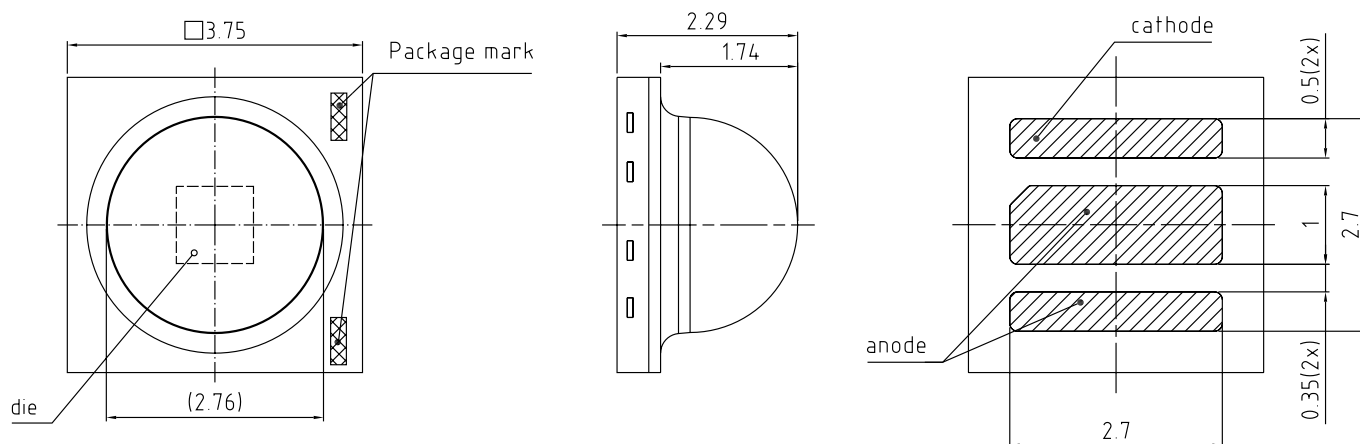

general tolerance ± 0.1

lead finish Au 

C67062-A0477-A1-02

Further Information:

Approximate Weight: 32.0 mg

Corrosion test: Class: 3B
Test condition: 40°C / 90 % RH / 15 ppm H₂S / 14 days (stricter than IEC 60068-2-43)

ESD advice: The device is protected by ESD device which is connected in parallel to the Chip.

Electrical Internal Circuit

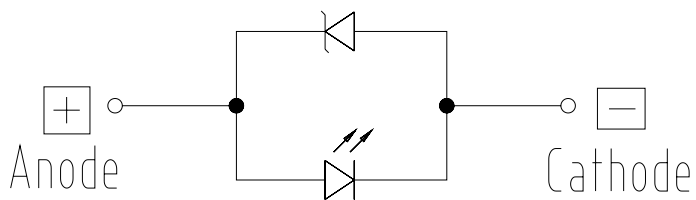

Recommended Solder Pad ¹⁰⁾

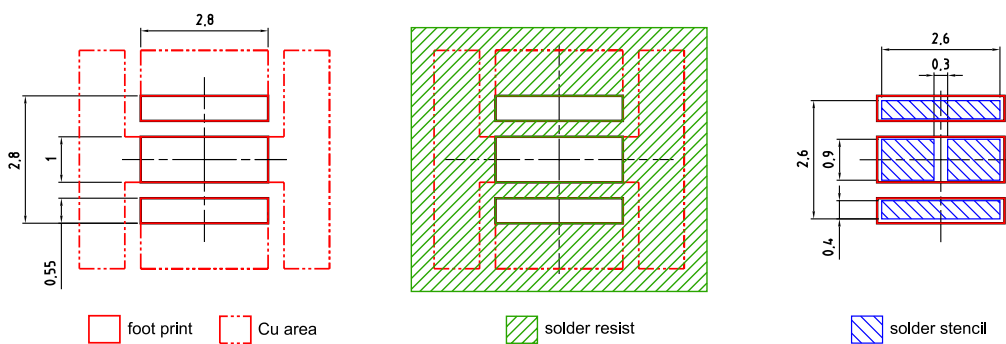

Component Location on Pad
(Component is generic for round lens design)

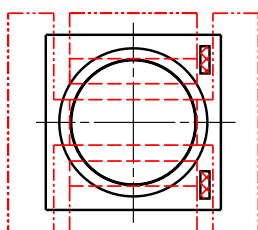

E062.3010.91 -06

For superior solder joint connectivity results we recommend soldering under standard nitrogen atmosphere. Package not suitable for ultra sonic cleaning.

Reflow Soldering Profile

Product complies to MSL Level 2 acc. to JEDEC J-STD-020E

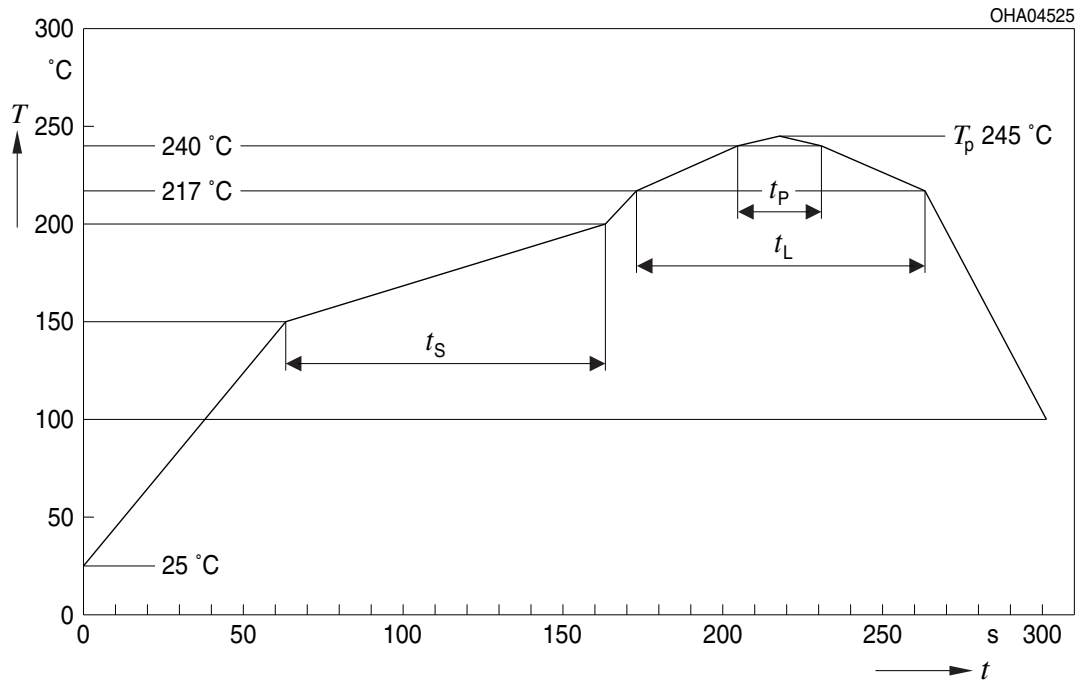

Profile Feature	Symbol	Pb-Free (SnAgCu) Assembly			Unit
		Minimum	Recommendation	Maximum	
Ramp-up rate to preheat ^{*)} 25 °C to 150 °C			2	3	K/s
Time t_s T_{Smin} to T_{Smax}	t_s	60	100	120	s
Ramp-up rate to peak ^{*)} T_{Smax} to T_p			2	3	K/s
Liquidus temperature	T_L		217		°C
Time above liquidus temperature	t_L		80	100	s
Peak temperature	T_p		245	260	°C
Time within 5 °C of the specified peak temperature $T_p - 5$ K	t_p	10	20	30	s
Ramp-down rate* T_p to 100 °C			3	6	K/s
Time 25 °C to T_p				480	s

All temperatures refer to the center of the package, measured on the top of the component
^{*)} slope calculation DT/Dt : Dt max. 5 s; fulfillment for the whole T-range

Taping ¹⁰⁾

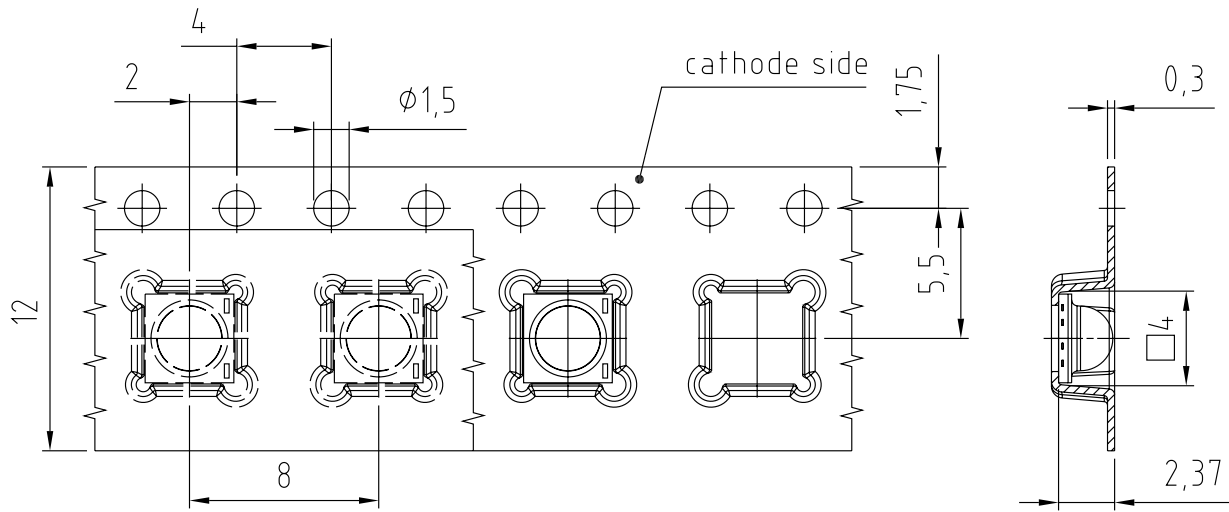

C67062-A0477-B4-02

Tape and Reel ¹¹⁾

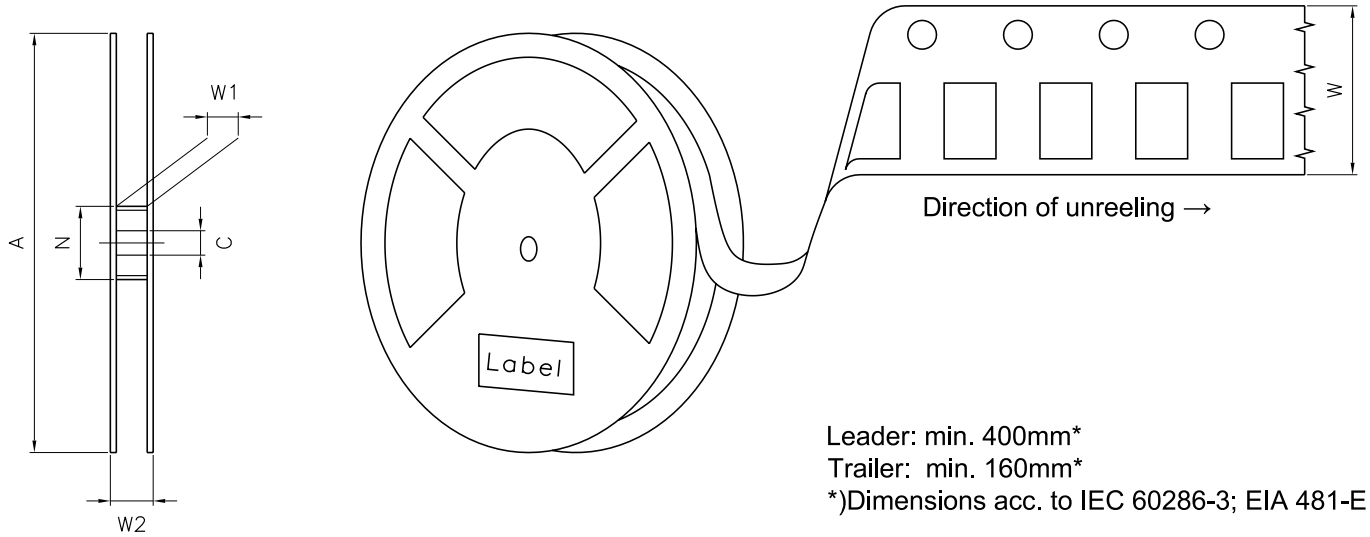

Reel Dimensions

A	W	N _{min}	W ₁	W _{2max}	Pieces per PU
180 mm	12 + 0.3 / - 0.1 mm	60 mm	12.4 + 2 mm	18.4 mm	600

Barcode-Product-Label (BPL)

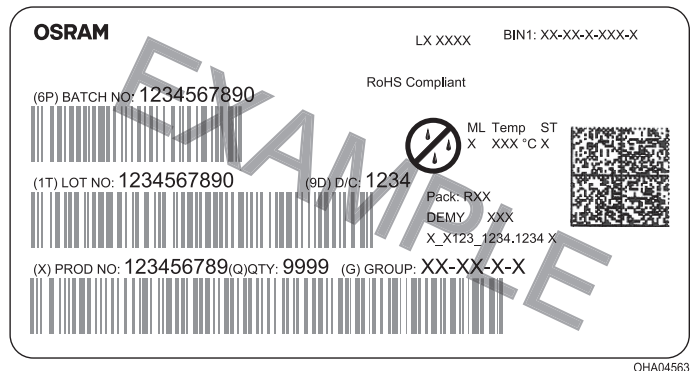

Dry Packing Process and Materials ¹⁰⁾

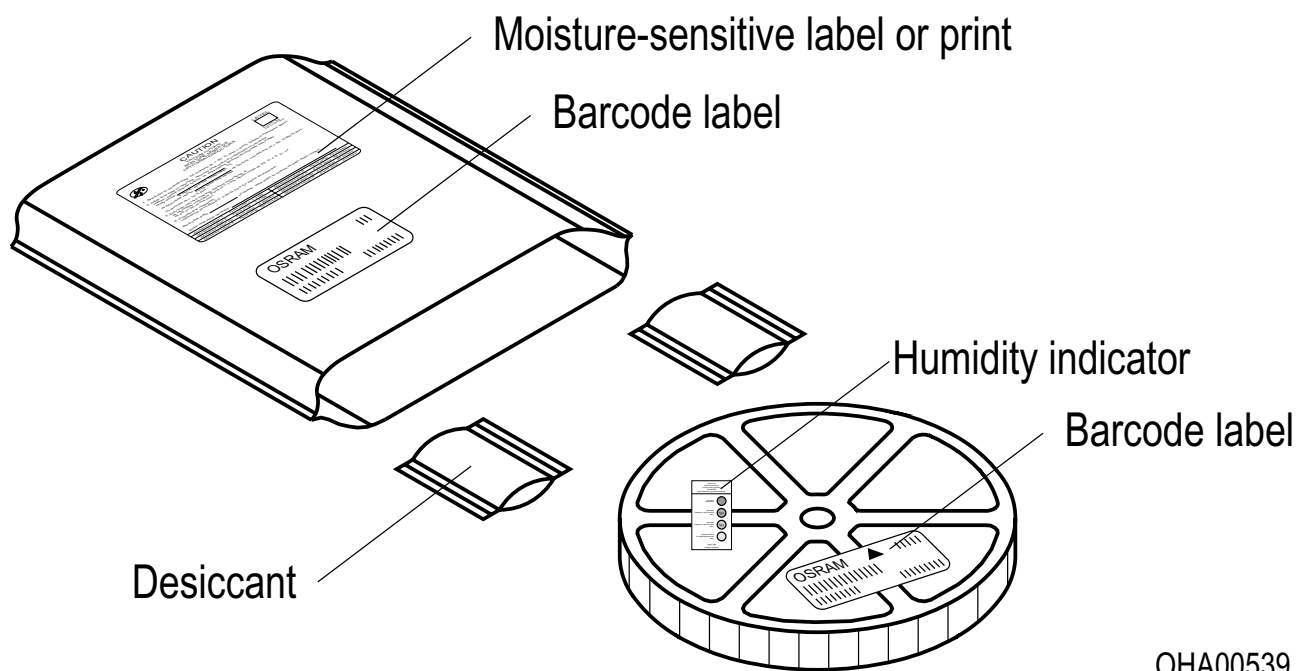

Moisture-sensitive product is packed in a dry bag containing desiccant and a humidity card according JEDEC-STD-033.

Notes

The evaluation of eye safety occurs according to the standard IEC 62471:2006 (photo biological safety of lamps and lamp systems). Within the risk grouping system of this IEC standard, the device specified in this data sheet falls into **exempt risk group - Exempt**.

Subcomponents of this device contain, in addition to other substances, metal filled materials including silver. Metal filled materials can be affected by environments that contain traces of aggressive substances. Therefore, we recommend that customers minimize device exposure to aggressive substances during storage, production, and use. Devices that showed visible discoloration when tested using the described tests above did show no performance deviations within failure limits during the stated test duration. Respective failure limits are described in the IEC60810.

For further application related information please visit <https://ams-osram.com/support/application-notes>

Disclaimer

Attention please!

The information describes the type of component and shall not be considered as assured characteristics. Terms of delivery and rights to change design reserved. Due to technical requirements components may contain dangerous substances.

For information on the types in question please contact our Sales Organization.

If printed or downloaded, please find the latest version on our website.

Packing

Please use the recycling operators known to you. We can also help you – get in touch with your nearest sales office. By agreement we will take packing material back, if it is sorted. You must bear the costs of transport. For packing material that is returned to us unsorted or which we are not obliged to accept, we shall have to invoice you for any costs incurred.

Product and functional safety devices/applications or medical devices/applications

Our components are not developed, constructed or tested for the application as safety relevant component or for the application in medical devices.

Our products are not qualified at module and system level for such application.

In case buyer – or customer supplied by buyer – considers using our components in product safety devices/ applications or medical devices/applications, buyer and/or customer has to inform our local sales partner immediately and we and buyer and /or customer will analyze and coordinate the customer-specific request between us and buyer and/or customer.

Glossary

- 1) **Radiant intensity:** Measured at a solid angle of $\Omega = 0.01$ sr
- 2) **Brightness:** The brightness values are measured with a tolerance of $\pm 11\%$.
- 3) **Reverse Operation:** This product is intended to be operated applying a forward current within the specified range. Applying any continuous reverse bias or forward bias below the voltage range of light emission shall be avoided because it may cause migration which can change the electro-optical characteristics or damage the LED.
- 4) **Wavelength:** The wavelengths are measured with a tolerance of ± 1 nm.
- 5) **Forward Voltage:** The forward voltages are measured with a tolerance of ± 0.1 V.
- 6) **Total radiant flux:** Measured with integrating sphere.
- 7) **Thermal resistance:** junction - soldering point, of the device only, mounted on an ideal heatsink (e.g. metal block)
- 8) **Typical Values:** Due to the special conditions of the manufacturing processes of semiconductor devices, the typical data or calculated correlations of technical parameters can only reflect statistical figures. These do not necessarily correspond to the actual parameters of each single product, which could differ from the typical data and calculated correlations or the typical characteristic line. If requested, e.g. because of technical improvements, these typ. data will be changed without any further notice.
- 9) **Testing temperature:** TA = 25°C (unless otherwise specified)
- 10) **Tolerance of Measure:** Unless otherwise noted in drawing, tolerances are specified with ± 0.1 and dimensions are specified in mm.
- 11) **Tape and Reel:** All dimensions and tolerances are specified acc. IEC 60286-3 and specified in mm.

Revision History

Version	Date	Change
1.0	2026-02-02	Derating (Diagrams) Electro - Optical Characteristics (Diagrams) Characteristics Taping Maximum Ratings
1.1	2026-02-18	Brightness Groups Taping
1.2	2026-02-25	Features Maximum Ratings
1.3	2026-04-02	Applications Maximum Ratings



EU RoHS and China RoHS compliant product

此产品符合欧盟 RoHS 指令的要求；
按照中国的相关法规和标准，
不含有毒有害物质或元素。

Published by ams-OSRAM AG

Tobelbader Strasse 30, 8141 Premstaetten, Austria

Phone +43 3136 500-0

ams-osram.com

© All rights reserved

am 

OSRAM