

# OSRAM GW Q9LR36.PM

## Datasheet

Published by **ams-OSRAM AG**

Tobelbader Strasse 30, 8141 Premstaetten, Austria

Phone +43 3136 500-0

[ams-osram.com](http://ams-osram.com)

© All rights reserved



## OSCONIQ™ S 5050

# GW Q9LR36.PM

The new QFN-cast 5050 LED delivers high efficacy and a DLC Premium-grade lifetime, expanding our 5050 portfolio for professional lighting applications.

Built on the proven OSCONIQ S 5050 leadframe, it offers enhanced mechanical robustness and corrosion resistance for reliable outdoor performance.



### Applications

- Indoor lighting
- Outdoor & industrial lighting

### Features

- Package: white SMT package, colored diffused resin
- Typ. Radiation: 120° (Lambertian emitter)
- Color temperature: 1800K - 6500K
- CRI: 70 (min.), 72 (typ.), R9: -50 (min.)
- ESD: 8 kV acc. to ANSI/ESDA/JEDEC JS-001 (HBM, Class 3B)
- Luminous Flux: typ. 226 lm @ 4000 K
- Luminous efficacy: typ. 228 lm/W @ 4000 K

## Ordering Information

Type	Color temperature	Luminous Flux <sup>1)</sup> $I_F = 45 \text{ mA}$ $\Phi_V$	Ordering Code
GW Q9LR36.PM-L7M3-XX512-1	1800 K	150 ... 210 lm	Q65115A3189
GW Q9LR36.PM-M1M7-XX510-1	2200 K	180 ... 250 lm	Q65115A3190
GW Q9LR36.PM-M2M9-XX58-1	2700 K	190 ... 270 lm	Q65115A3191
GW Q9LR36.PM-M4N1-XX57-1	3000 K	210 ... 290 lm	Q65115A3195
GW Q9LR36.PM-M4N1-XX56-1	3500 K	210 ... 290 lm	Q65115A3194
GW Q9LR36.PM-M5N2-XX55-1	4000 K	220 ... 300 lm	Q65115A3199
GW Q9LR36.PM-M5N2-XX53-1	5000 K	220 ... 300 lm	Q65115A3197
GW Q9LR36.PM-M4N1-XX52-1	5700 K	210 ... 290 lm	Q65115A3193
GW Q9LR36.PM-M4N1-XX51-1	6500 K	210 ... 290 lm	Q65115A3192

## Maximum Ratings

Parameter	Symbol		Values
Operating Temperature	$T_{op}$	min.	-40 °C
		max.	105 °C
Storage Temperature	$T_{stg}$	min.	-40 °C
		max.	105 °C
Junction Temperature	$T_j$	max.	125 °C
Forward Current $T_j = 25\text{ °C}$	$I_F$	min.	10 mA
		max.	265 mA
Reverse voltage <sup>2)</sup>	$V_R$		Not designed for reverse operation
ESD withstand voltage acc. to ANSI/ESDA/JEDEC JS-001 (HBM, Class 3B)	$V_{ESD}$		8 kV

## Characteristics

$I_F = 45 \text{ mA}$ ;  $T_J = 25 \text{ }^\circ\text{C}$

Parameter	Symbol		Values
Viewing angle at 50% $I_V$	$2\phi$	typ.	120 °
Forward Voltage <sup>3)</sup> $I_F = 45 \text{ mA}$	$V_F$	min. typ. max.	20.80 V 22.00 V 23.20 V
Reverse current <sup>2)</sup>	$I_R$		Not designed for reverse operation
Color Rendering Index <sup>4)</sup>	CRI	min. typ.	70 72
Color Rendering Index (R9) <sup>4)</sup>	CRI (R9)	min.	-50
Electrical thermal resistance junction/solderpoint with efficiency $\eta_e = 64 \text{ } \%$	$R_{thJS \text{ elec.}}$	typ.	1.0 K / W

## Electro - Optical Characteristics <sup>5)</sup>

$T_J = 25 \text{ }^\circ\text{C}$ ; CRI = 70; 4000 K

Forward Current $I_F$	Forward Voltage typ. $V_F$	Power typ. P	Luminous Flux typ. $\Phi_V$	Luminous efficacy typ. $\eta$
45 mA	22.00 V	1.0 W	226 lm	228 lm/W
90 mA	23.05 V	2.1 W	439 lm	211 lm/W
150 mA	24.47 V	3.7 W	706 lm	192 lm/W
160 mA	24.58 V	3.9 W	750 lm	191 lm/W
200 mA	25.46 V	5.1 W	915 lm	180 lm/W
265 mA	26.78 V	7.1 W	1191 lm	168 lm/W

## Brightness Groups

Group	Luminous Flux <sup>1)</sup> $I_F = 45 \text{ mA}$ min. $\Phi_V$	Luminous Flux <sup>1)</sup> $I_F = 45 \text{ mA}$ max. $\Phi_V$
L7	150 lm	160 lm
L8	160 lm	170 lm
L9	170 lm	180 lm
M1	180 lm	190 lm
M2	190 lm	200 lm
M3	200 lm	210 lm
M4	210 lm	220 lm
M5	220 lm	230 lm
M6	230 lm	240 lm
M7	240 lm	250 lm
M8	250 lm	260 lm
M9	260 lm	270 lm
MF	270 lm	280 lm
N1	280 lm	290 lm
N2	290 lm	300 lm

## Forward Voltage Groups

Group	Forward Voltage <sup>3)</sup> $I_F = 45 \text{ mA}$ min. $V_F$	Forward Voltage <sup>3)</sup> $I_F = 45 \text{ mA}$ max. $V_F$
K8	20.80 V	21.60 V
T8	21.60 V	22.40 V
28	22.40 V	23.20 V

Chromaticity Coordinate Groups <sup>1)</sup>

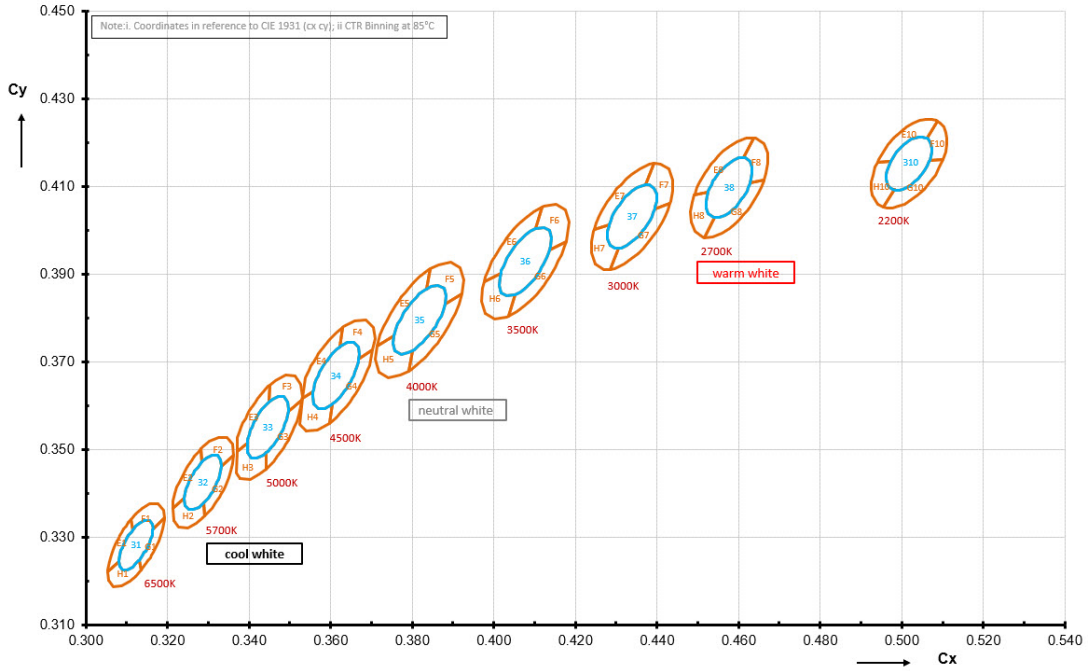

Chromaticity Coordinate Groups <sup>1)</sup>

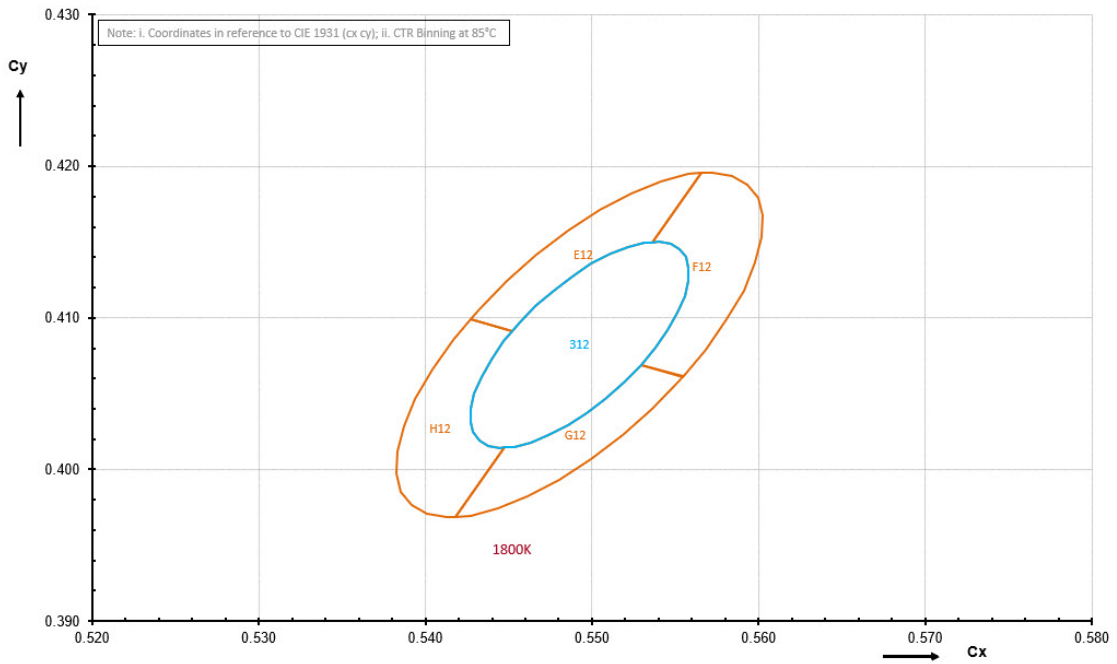

## Chromaticity Coordinate Groups

CCT	Center Cx	Center Cy	3step a	3step b	5step a	5step b	∅
1800 K	0.5492	0.4082	0.0096	0.0046	0.016	0.0077	47.3
2200 K	0.5020	0.4156	0.0072	0.004	0.012	0.0067	39.9
2700 K	0.4577	0.4098	0.008	0.0041	0.0133	0.0068	54.1
3000 K	0.4339	0.4032	0.0086	0.0042	0.0142	0.0069	53.7
3500 K	0.4077	0.3929	0.0093	0.0042	0.0155	0.0069	53.9
4000 K	0.3818	0.3796	0.0094	0.0041	0.0157	0.0068	53.4
5000 K	0.3446	0.3551	0.0081	0.0035	0.0135	0.0059	59.8
5700 K	0.3287	0.3425	0.0072	0.0032	0.0119	0.0052	58.8
6500 K	0.3123	0.3282	0.0066	0.0027	0.011	0.0045	58.1

CCT	Group	1		2		3		4		5	
		Cx	Cy	Cx	Cy	Cx	Cy	Cx	Cy	Cx	Cy
1800 K	E	0.5566	0.4195	0.5427	0.4099	0.5452	0.4091	0.5536	0.4150		
	F	0.5566	0.4195	0.5555	0.4061	0.5529	0.4069	0.5536	0.4150		
	G	0.5555	0.4061	0.5418	0.3969	0.5448	0.4015	0.5529	0.4069		
	H	0.5448	0.4015	0.5452	0.4091	0.5427	0.4099	0.5418	0.3969		
2200 K	E	0.5088	0.4249	0.4941	0.4156	0.4973	0.4157	0.5061	0.4210		
	F	0.5088	0.4249	0.5101	0.4161	0.5068	0.4160	0.5061	0.4210		
	G	0.5101	0.4161	0.4955	0.4054	0.4981	0.4093	0.5068	0.4158		
	H	0.4981	0.4093	0.4973	0.4157	0.4941	0.4156	0.4955	0.4054		
2700 K	E	0.4637	0.4212	0.4491	0.4081	0.4526	0.4088	0.4613	0.4166		
	F	0.4637	0.4212	0.4663	0.4115	0.4628	0.4108	0.4613	0.4166		
	G	0.4663	0.4115	0.4517	0.3984	0.4541	0.4030	0.4628	0.4108		
	H	0.4541	0.4030	0.4526	0.4088	0.4491	0.4081	0.4517	0.3984		
3000 K	E	0.4393	0.4153	0.4246	0.4002	0.4283	0.4014	0.4371	0.4105		
	F	0.4393	0.4153	0.4432	0.4062	0.4395	0.4050	0.4371	0.4105		
	G	0.4432	0.4062	0.4285	0.3911	0.4307	0.3960	0.4395	0.4050		
	H	0.4307	0.3960	0.4283	0.4014	0.4246	0.4002	0.4285	0.3911		
3500 K	E	0.4118	0.4054	0.3977	0.3883	0.4017	0.3902	0.4102	0.4004		
	F	0.4118	0.4054	0.4177	0.3975	0.4137	0.3956	0.4102	0.4004		
	G	0.4177	0.3975	0.4036	0.3804	0.4052	0.3854	0.4137	0.3956		
	H	0.4052	0.3854	0.4017	0.3902	0.3977	0.3883	0.4036	0.3804		
4000 K	E	0.3845	0.3913	0.3714	0.3737	0.3756	0.3760	0.3834	0.3866		
	F	0.3845	0.3913	0.3922	0.3855	0.3880	0.3832	0.3834	0.3866		
	G	0.3922	0.3855	0.3791	0.3679	0.3802	0.3726	0.3880	0.3832		
	H	0.3802	0.3726	0.3756	0.3760	0.3714	0.3737	0.3791	0.3679		
5000 K	E	0.3451	0.3648	0.3372	0.3528	0.3371	0.3496	0.3396	0.3514	0.3449	0.3609
	F	0.3451	0.3648	0.3530	0.3612	0.3496	0.3588	0.3449	0.3609		
	G	0.3530	0.3612	0.3441	0.3454	0.3443	0.3493	0.3496	0.3588		
	H	0.3443	0.3493	0.3396	0.3514	0.3371	0.3496	0.3369	0.3445	0.3441	0.3454
5700 K	E	0.3283	0.3502	0.3212	0.3373	0.3213	0.3365	0.3242	0.3388	0.3284	0.3471
	F	0.3283	0.3502	0.3363	0.3486	0.3332	0.3462	0.3284	0.3471		
	G	0.3363	0.3486	0.3291	0.3348	0.3290	0.3379	0.3332	0.3462		
	H	0.3291	0.3348	0.3215	0.3337	0.3213	0.3365	0.3242	0.3388	0.3290	0.3379

---

6500 K	E	0.3110	0.3340	0.3054	0.3220	0.3082	0.3245	0.3115	0.3317
	F	0.3110	0.3340	0.3192	0.3344	0.3165	0.3319	0.3115	0.3317
	G	0.3192	0.3344	0.3136	0.3224	0.3131	0.3247	0.3165	0.3319
	H	0.3136	0.3224	0.3054	0.3220	0.3082	0.3245	0.3131	0.3247

---

---

## Group Name on Label

### Example: L7-28

Brightness	Forward Voltage
------------	-----------------

---

L7	28
----	----

---

## Relative Spectral Emission <sup>5)</sup>

$$\Phi_{\text{rel}} = f(\lambda); I_F = 45 \text{ mA}; T_J = 25 \text{ }^\circ\text{C}$$

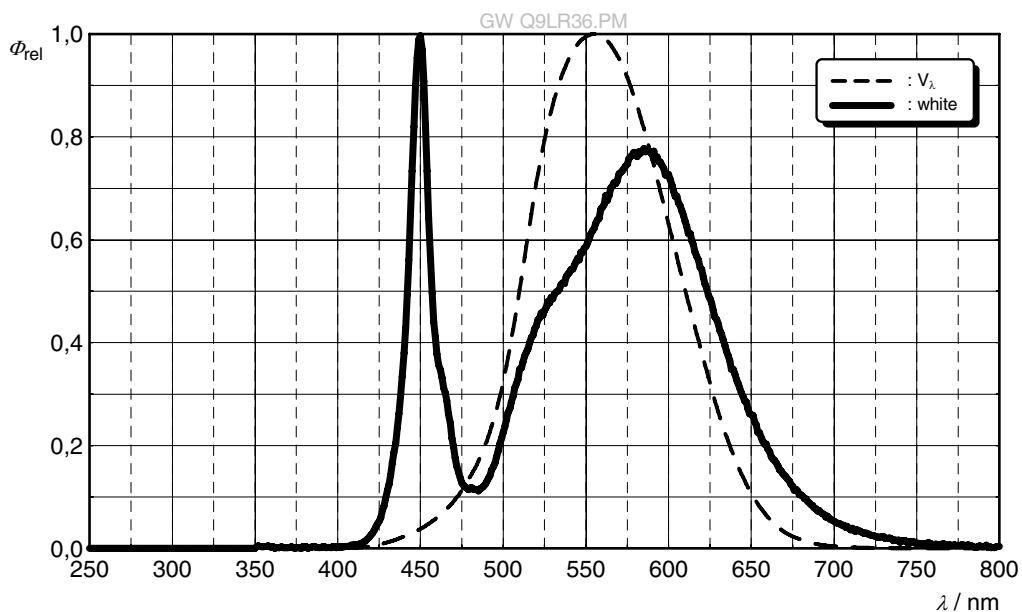

## Radiation Characteristics <sup>5)</sup>

$$I_{\text{rel}} = f(\varphi); T_J = 25 \text{ }^\circ\text{C}$$

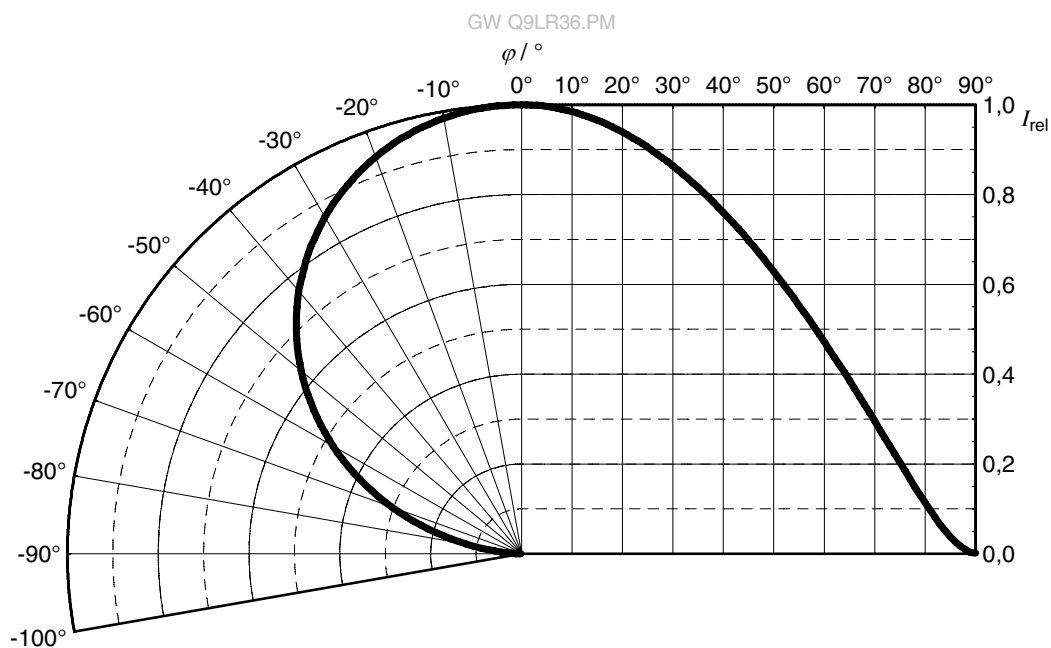

### Forward current <sup>5)</sup>

$$I_F = f(V_F); T_J = 25\text{ °C}$$

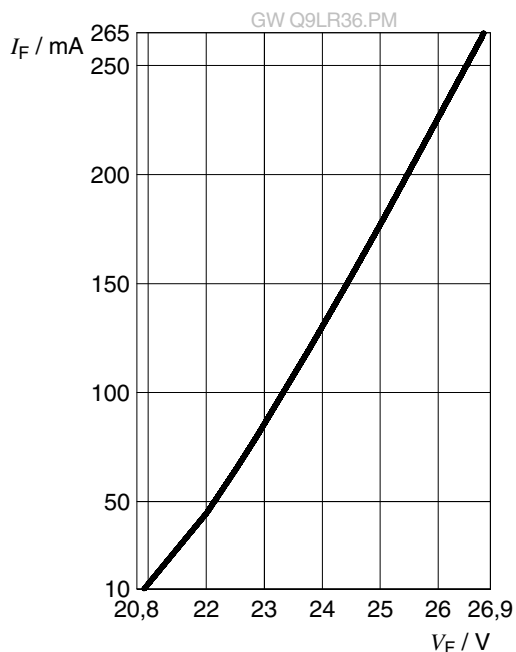

### Relative Luminous Flux <sup>5), 6)</sup>

$$\Phi_V / \Phi_V(45\text{ mA}) = f(I_F); T_J = 25\text{ °C}$$

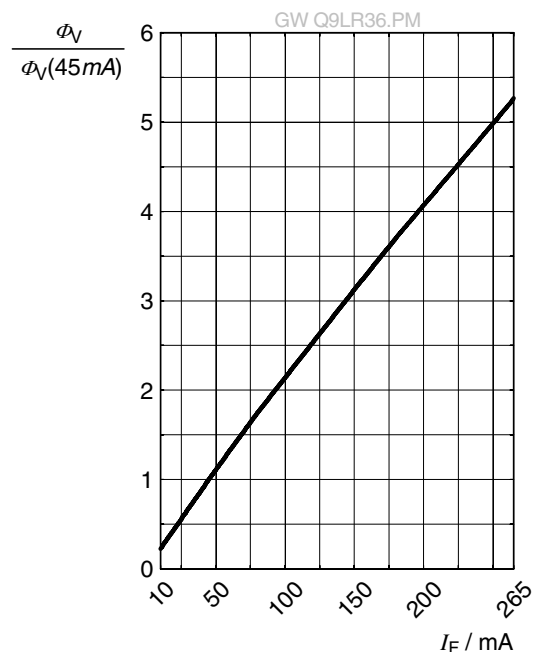

### Chromaticity Coordinate Shift <sup>5)</sup>

$$C_x, C_y = f(I_F); T_J = 25\text{ °C}$$

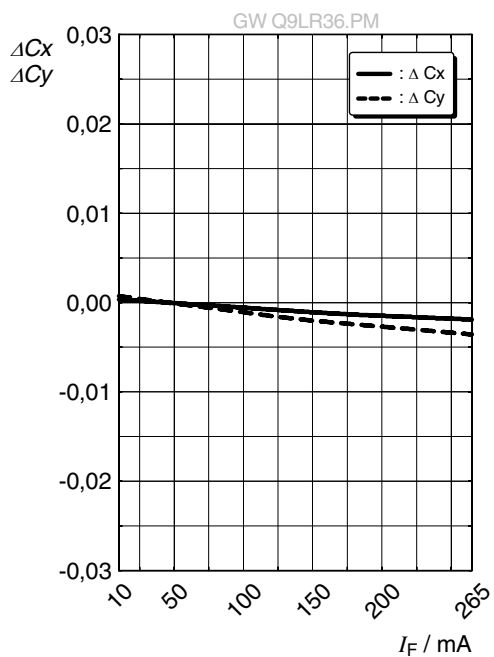

**Forward Voltage** <sup>5)</sup>

$\Delta V_F = V_F - V_F(25\text{ }^\circ\text{C}) = f(T_j); I_F = 45\text{ mA}$

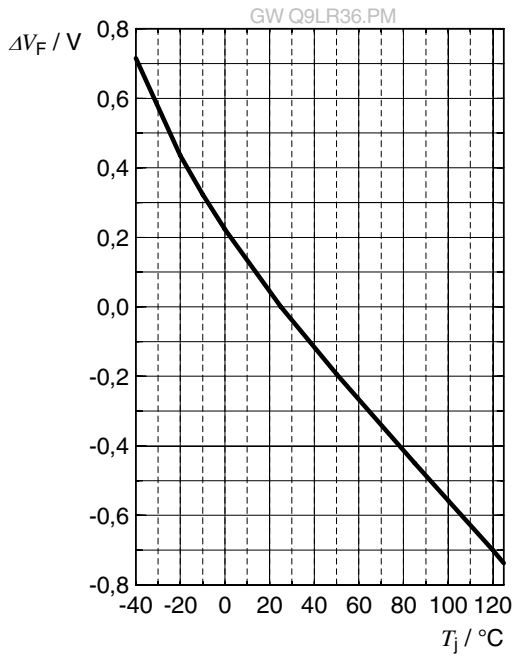

**Relative Luminous Flux** <sup>5)</sup>

$\Phi_v / \Phi_v(25\text{ }^\circ\text{C}) = f(T_j); I_F = 45\text{ mA}$

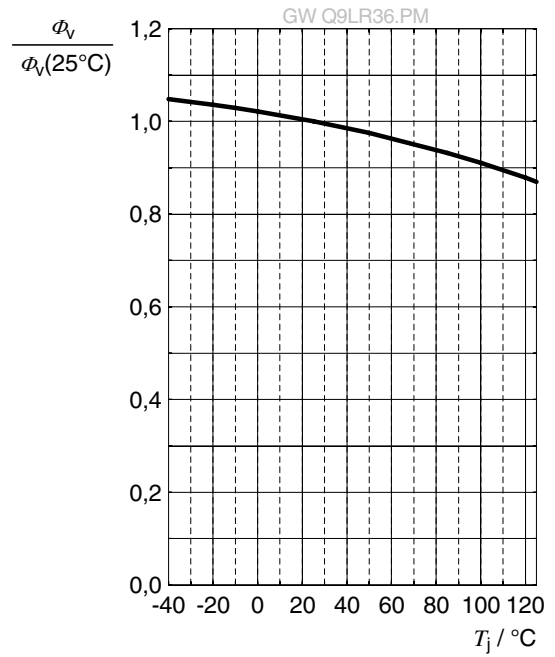

**Chromaticity Coordinate Shift** <sup>5)</sup>

$C_x, C_y = f(T_j); I_F = 45\text{ mA}$

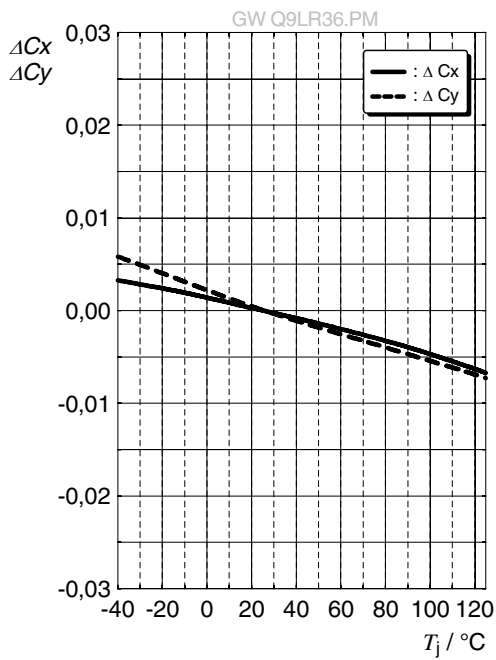

### Max. Permissible Forward Current <sup>7)</sup>

$$I_F = f(T)$$

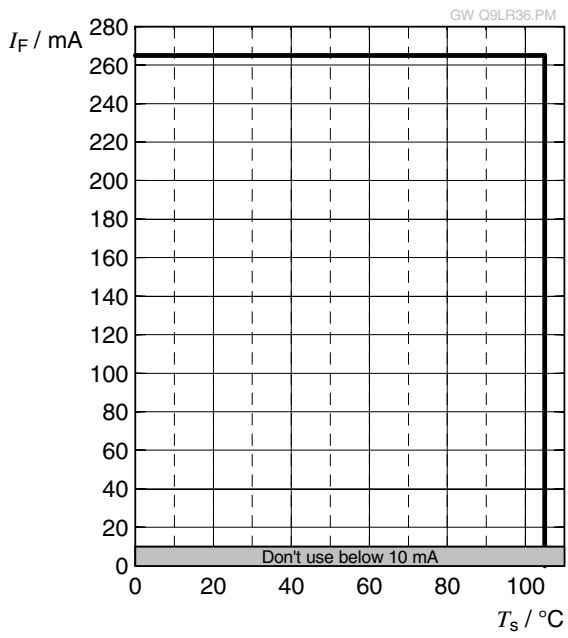

## Dimensional Drawing <sup>8)</sup>

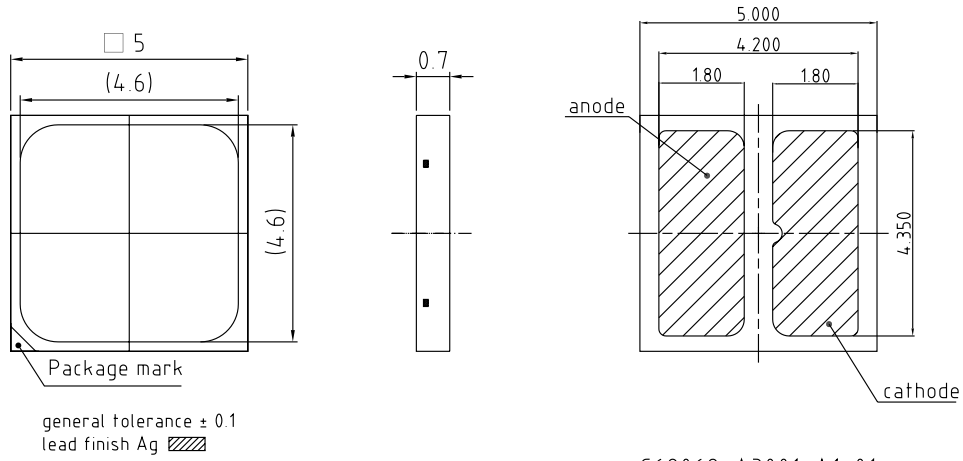

C69062-A3001-A1-01

## Further Information:

**Approximate Weight:** 67.0 mg

**Package marking:** Cathode

Recommended Solder Pad <sup>8)</sup>

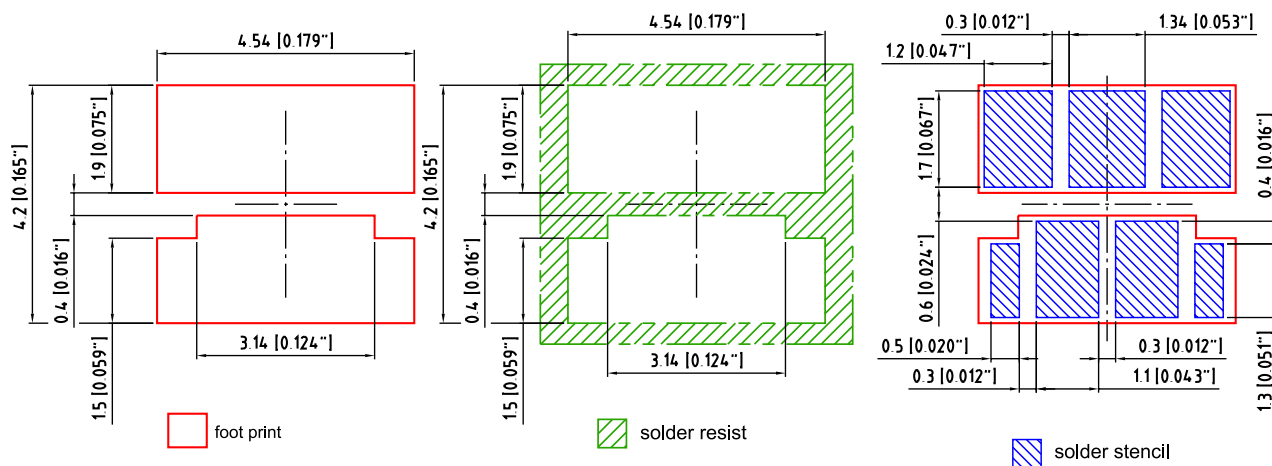

E062.3010.146 -01

For superior solder joint connectivity results we recommend soldering under standard nitrogen atmosphere. Package not suitable for any kind of wet cleaning or ultrasonic cleaning.

## Reflow Soldering Profile

Product complies to MSL Level 3 acc. to JEDEC J-STD-020E

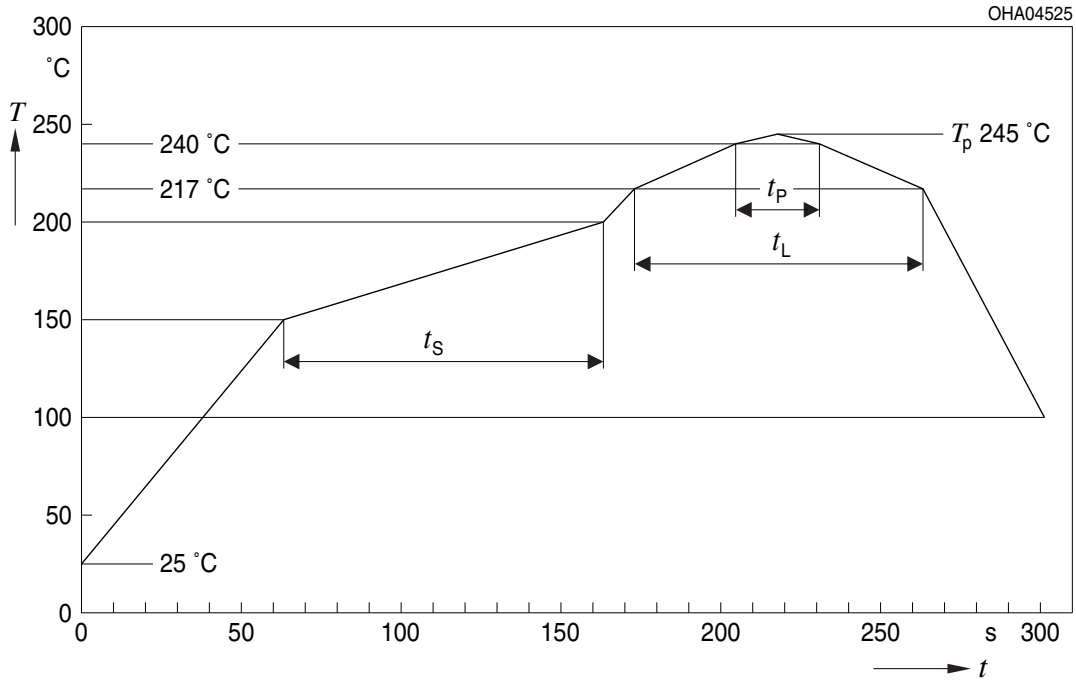

Profile Feature	Symbol	Pb-Free (SnAgCu) Assembly			Unit
		Minimum	Recommendation	Maximum	
Ramp-up rate to preheat <sup>*)</sup> 25 °C to 150 °C			2	3	K/s
Time $t_s$ $T_{Smin}$ to $T_{Smax}$	$t_s$	60	100	120	s
Ramp-up rate to peak <sup>*)</sup> $T_{Smax}$ to $T_p$			2	3	K/s
Liquidus temperature	$T_L$		217		°C
Time above liquidus temperature	$t_L$		80	100	s
Peak temperature	$T_p$		245	260	°C
Time within 5 °C of the specified peak temperature $T_p - 5$ K	$t_p$	10	20	30	s
Ramp-down rate* $T_p$ to 100 °C			3	6	K/s
Time 25 °C to $T_p$				480	s

All temperatures refer to the center of the package, measured on the top of the component  
<sup>\*)</sup> slope calculation  $DT/Dt$ :  $Dt$  max. 5 s; fulfillment for the whole T-range

Taping <sup>8)</sup>

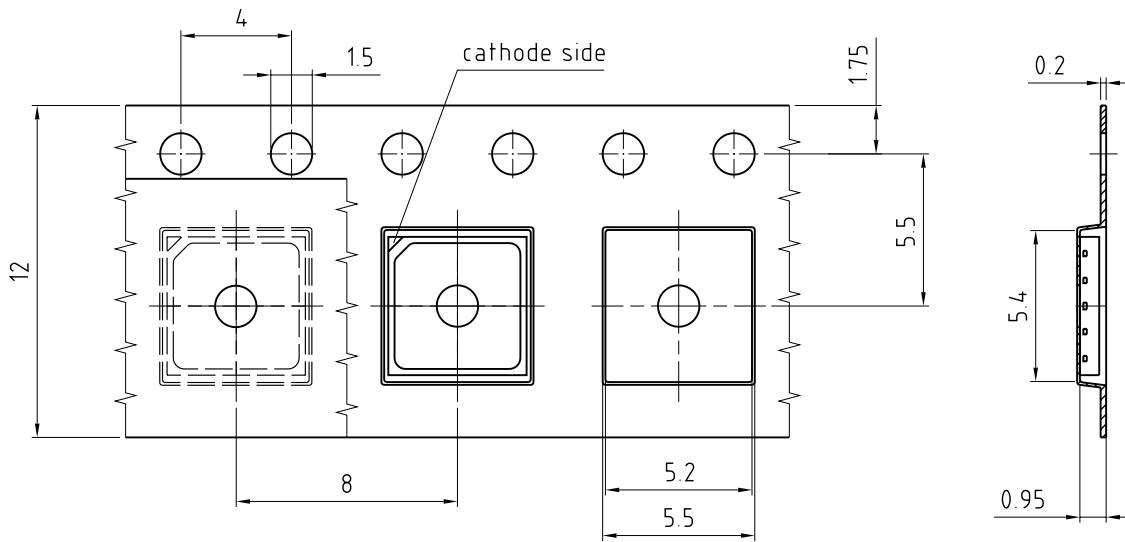

C69062-A0059-B4-01

## Tape and Reel <sup>9)</sup>

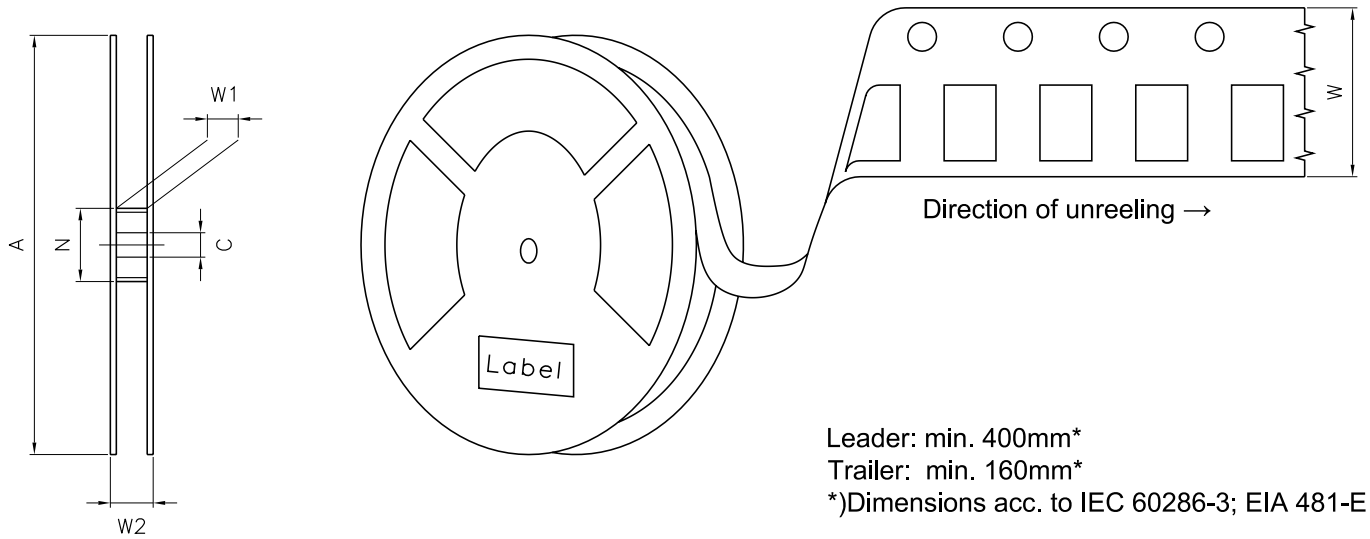

## Reel Dimensions

A	W	N <sub>min</sub>	W <sub>1</sub>	W <sub>2max</sub>	Pieces per PU
180 mm	12 + 0.3 / - 0.1 mm	60 mm	12.4 + 2 mm	18.4 mm	2000

**Barcode-Product-Label (BPL)**

**OSRAM** LX XXXX    BIN1: XX-XX-X-XXX-X

RoHS Compliant

(6P) BATCH NO: 1234567890 ML Temp    ST  
X    XXX °C X

(1T) LOT NO: 1234567890 (9D) D/C: 1234

Pack: RXX  
DEMY    XXX  
X\_X123\_1234.1234 X

(X) PROD NO: 123456789(Q)QTY: 9999 (G) GROUP: XX-XX-X-X

OHA04563

**Dry Packing Process and Materials**

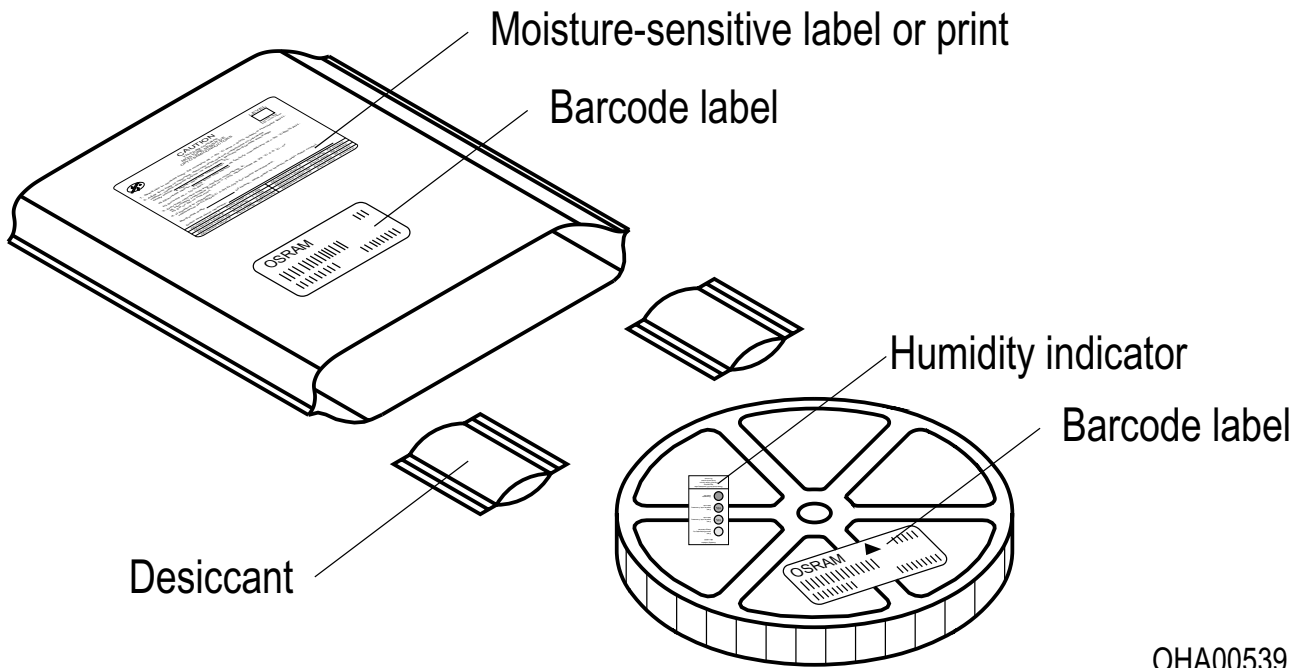

OHA00539

Moisture-sensitive product is packed in a dry bag containing desiccant and a humidity card according JEDEC-STD-033.

---

## Notes

The evaluation of eye safety occurs according to the standard IEC 62471:2006 (photo biological safety of lamps and lamp systems). Within the risk grouping system of this IEC standard, the device specified in this data sheet fall into the class **moderate risk (exposure time 0.25 s)**. Under real circumstances (for exposure time, conditions of the eye pupils, observation distance), it is assumed that no endangerment to the eye exists from these devices. As a matter of principle, however, it should be mentioned that intense light sources have a high secondary exposure potential due to their blinding effect. When looking at bright light sources (e.g. headlights), temporary reduction in visual acuity and afterimages can occur, leading to irritation, annoyance, visual impairment, and even accidents, depending on the situation.

Subcomponents of this device contain, in addition to other substances, metal filled materials including silver. Metal filled materials can be affected by environments that contain traces of aggressive substances. Therefore, we recommend that customers minimize device exposure to aggressive substances during storage, production, and use. Devices that showed visible discoloration when tested using the described tests above did show no performance deviations within failure limits during the stated test duration. Respective failure limits are described in the IEC60810.

This device is designed for specific/recommended applications only. Please consult OSRAM Opto Semiconductors Sales Staff in advance for detailed information on other non-recommended applications (e.g. automotive).

Change management for this component is aligned with the requirements of the lighting market.

For further application related information please visit <https://ams-osram.com/support/application-notes>

## Disclaimer

### Attention please!

The information describes the type of component and shall not be considered as assured characteristics. Terms of delivery and rights to change design reserved. Due to technical requirements components may contain dangerous substances.

For information on the types in question please contact our Sales Organization.

If printed or downloaded, please find the latest version on our website.

### Packing

Please use the recycling operators known to you. We can also help you – get in touch with your nearest sales office. By agreement we will take packing material back, if it is sorted. You must bear the costs of transport. For packing material that is returned to us unsorted or which we are not obliged to accept, we shall have to invoice you for any costs incurred.

### Product and functional safety devices/applications or medical devices/applications

Our components are not developed, constructed or tested for the application as safety relevant component or for the application in medical devices.

Our products are not qualified at module and system level for such application.

In case buyer – or customer supplied by buyer – considers using our components in product safety devices/ applications or medical devices/applications, buyer and/or customer has to inform our local sales partner immediately and we and buyer and /or customer will analyze and coordinate the customer-specific request between us and buyer and/or customer.

---

## Glossary

- 1) **Brightness:** Brightness values are measured during a current pulse of typically 10 ms, with a tolerance of +/- 7%.
- 2) **Reverse Operation:** Not designed for reverse operation. Continuous reverse operation can cause migration and damage of the device.
- 3) **Forward Voltage:** The Forward voltage is measured during a current pulse duration of typically 1 ms with a tolerance of  $\pm 0.05V$ .
- 4) **Color reproduction index:** Color reproduction index values (CRI-RA) are measured during a current pulse of typically 10 ms and with a tolerance of  $\pm 2$ .
- 5) **Typical Values:** Due to the special conditions of the manufacturing processes of semiconductor devices, the typical data or calculated correlations of technical parameters can only reflect statistical figures. These do not necessarily correspond to the actual parameters of each single product, which could differ from the typical data and calculated correlations or the typical characteristic line. If requested, e.g. because of technical improvements, these typ. data will be changed without any further notice.
- 6) **Characteristic curve:** In the range where the line of the graph is broken, you must expect higher differences between single devices within one packing unit.
- 7) **Thermal Resistance:**  $R_{th\ max}$  is based on statistic values ( $6\sigma$ ) used for Derating.
- 8) **Tolerance of Measure:** Unless otherwise noted in drawing, tolerances are specified with  $\pm 0.1$  and dimensions are specified in mm.
- 9) **Tape and Reel:** All dimensions and tolerances are specified acc. IEC 60286-3 and specified in mm.

---

## Revision History

Version	Date	Change
1.0	2026-03-26	Initial Version

---



EU RoHS and China RoHS compliant product

此产品符合欧盟 RoHS 指令的要求；  
按照中国的相关法规和标准，  
不含有毒有害物质或元素。

**Published by ams-OSRAM AG**

Tobelbader Strasse 30, 8141 Premstaetten, Austria

Phone +43 3136 500-0

[ams-osram.com](http://ams-osram.com)

© All rights reserved

**am** 

**OSRAM**