

OSRAM SFH 4775S

Datasheet

Published by **ams-OSRAM AG**

Tobelbader Strasse 30, 8141 Premstaetten, Austria

Phone +43 3136 500-0

ams-osram.com

© All rights reserved



SYNIOS® P2720

SFH 4775S

IR SYNIOS P2720 - 120°



Applications

- Access Control & Security
- Authentication
- Body Tracking
- Factory Automation
- Home & Building Automation
- Medical Lighting

Features

- Package: clear silicone
- ESD: 2 kV acc. to ANSI/ESDA/JEDEC JS-001 (HBM, Class 2)
- IR lightsource with high efficiency
- Double stack emitter
- Low thermal resistance (Max. 9 K/W)
- Optimized for high brightness DC operation
- Centroid wavelength options 920nm and 940nm

Ordering Information

| Type | Total radiant flux ¹⁾²⁾ $I_F = 1000 \text{ mA}; t_p = 10 \text{ ms}$ Φ_e | Ordering Code |
|-----------------------|--|---------------|
| SFH 4775S | 1000 ... 1600 mW | Q65112A7448 |
| SFH 4775S-EB2FB1-11 | 1000 ... 1600 mW | Q65113A6460 |
| SFH 4775S-EB2FB1-1113 | 1000 ... 1600 mW | Q65113A6458 |

Q65112A7448 exclusively contains wavelength bin 13

Maximum Ratings

 $T_A = 25\text{ °C}$

| Parameter | Symbol | | Values |
|--|----------------|------|---------|
| Operating temperature | T_{op} | min. | -40 °C |
| | | max. | 100 °C |
| Storage temperature | T_{stg} | min. | -40 °C |
| | | max. | 100 °C |
| Junction temperature | T_j | max. | 145 °C |
| Forward current | I_F | max. | 1500 mA |
| Forward current pulsed $t_p \leq 800\ \mu\text{s}$; $D \leq 0.005$ | $I_{F\ pulse}$ | max. | 3 A |
| Reverse current ³⁾ | I_R | max. | 200 mA |
| ESD withstand voltage acc. to ANSI/ESDA/JEDEC JS-001 (HBM, Class 2) | V_{ESD} | max. | 2 kV |

For the forward current and power consumption please see "maximum permissible forward current" diagram

Characteristics

$I_F = 1000 \text{ mA}$; $t_p = 10 \text{ ms}$; $T_A = 25 \text{ °C}$

| Parameter | Symbol | Values |
|---|-----------------------------|----------------------------|
| Centroid wavelength ⁴⁾ | $\lambda_{\text{centroid}}$ | min. 912 nm max. 950 nm |
| Spectral bandwidth at 50% $I_{\text{rel,max}}$ (FWHM) | $\Delta\lambda$ | typ. 37 nm |
| Half angle | φ | typ. 60 ° |
| Dimensions of active chip area | L x W | typ. 1 x 1 mm x mm |
| Rise time (10% / 90%) $I_F = 3 \text{ A}$; $R_L = 50 \Omega$ | t_r | typ. 12 ns |
| Fall time (10% / 90%) $I_F = 3 \text{ A}$; $R_L = 50 \Omega$ | t_f | typ. 15 ns |
| Forward voltage ⁵⁾ | V_F | typ. 2.9 V max. 3.2 V |
| Forward voltage ⁵⁾ $I_F = 1.5 \text{ A}$; $t_p = 100 \mu\text{s}$ | V_F | typ. 3.05 V max. 3.6 V |
| Forward voltage ⁵⁾ $I_F = 3 \text{ A}$; $t_p = 100 \mu\text{s}$ | V_F | typ. 3.5 V max. 4.1 V |
| Reverse voltage ³⁾ $I_R = 20 \text{ mA}$ | V_R | max. 1.2 V |
| Reverse voltage (ESD device) ³⁾ | $V_{\text{RES D}}$ | min. 5 V |
| Radiant intensity ⁶⁾ $I_F = 1000 \text{ mA}$; $t_p = 10 \text{ ms}$ | I_e | typ. 420 mW/sr |
| Radiant intensity ⁶⁾ $I_F = 1.5 \text{ A}$; $t_p = 100 \mu\text{s}$ | I_e | typ. 620 mW/sr |
| Total radiant flux ¹⁾ $I_F = 1.5 \text{ A}$; $t_p = 100 \mu\text{s}$ | Φ_e | typ. 2000 mW |
| Temperature coefficient of voltage | TC_V | typ. -2 mV / K |
| Temperature coefficient of brightness | TC_I | typ. -0.3 % / K |
| Temperature coefficient of wavelength | TC_λ | typ. 0.3 nm / K |
| Thermal resistance junction solder point real ⁷⁾ | $R_{\text{thJS real}}$ | max. 9.0 K / W |

Brightness Groups

$T_A = 25\text{ °C}$

| Group | Total radiant flux ¹⁾²⁾ $I_F = 1\text{ A}; t_p = 10\text{ ms}$ min. Φ_e | Total radiant flux ¹⁾²⁾ $I_F = 1\text{ A}; t_p = 10\text{ ms}$ max. Φ_e |
|-------|--|--|
| EB2 | 1000 mW | 1120 mW |
| FA1 | 1120 mW | 1250 mW |
| FA2 | 1250 mW | 1400 mW |
| FB1 | 1400 mW | 1600 mW |

Only one group in one packing unit.

Centroid Wavelength

| Group | Centroid wavelength ⁴⁾ | |
|-------|-------------------------------------|-------------------------------------|
| | min. $\lambda_{\text{centroid}}$ | max. $\lambda_{\text{centroid}}$ |
| 11 | 912 nm | 925 nm |
| 12 | 925 nm | 930 nm |
| 13 | 930 nm | 950 nm |

Relative Spectral Emission 8), 9)

$I_{e,rel} = f(\lambda); I_F = 1000 \text{ mA}; t_p = 10 \text{ ms}$

Centroid Wavelength Group 11

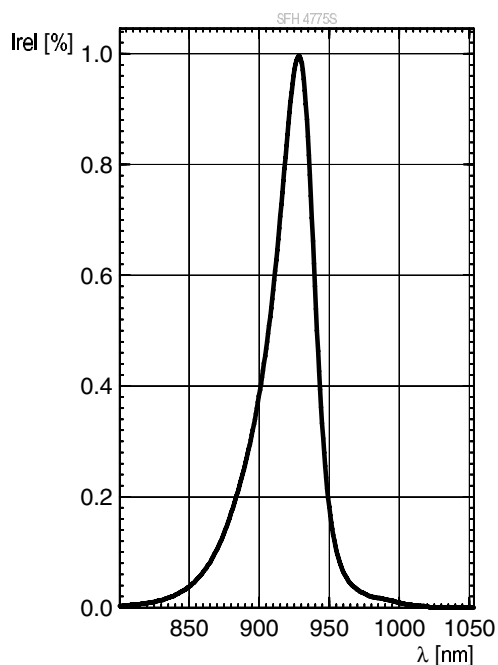

Relative Spectral Emission 8), 9)

$I_{e,rel} = f(\lambda); I_F = 1000 \text{ mA}; t_p = 10 \text{ ms}$

Centroid Wavelength Group 13

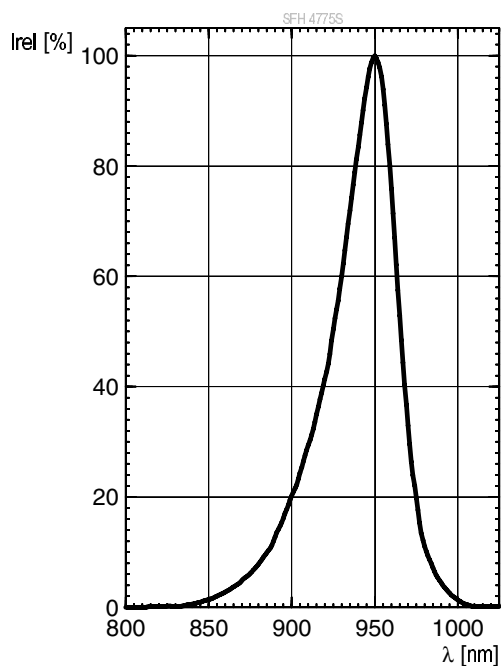

Radiation Characteristics 8), 9)

$I_{e,rel} = f(\varphi)$

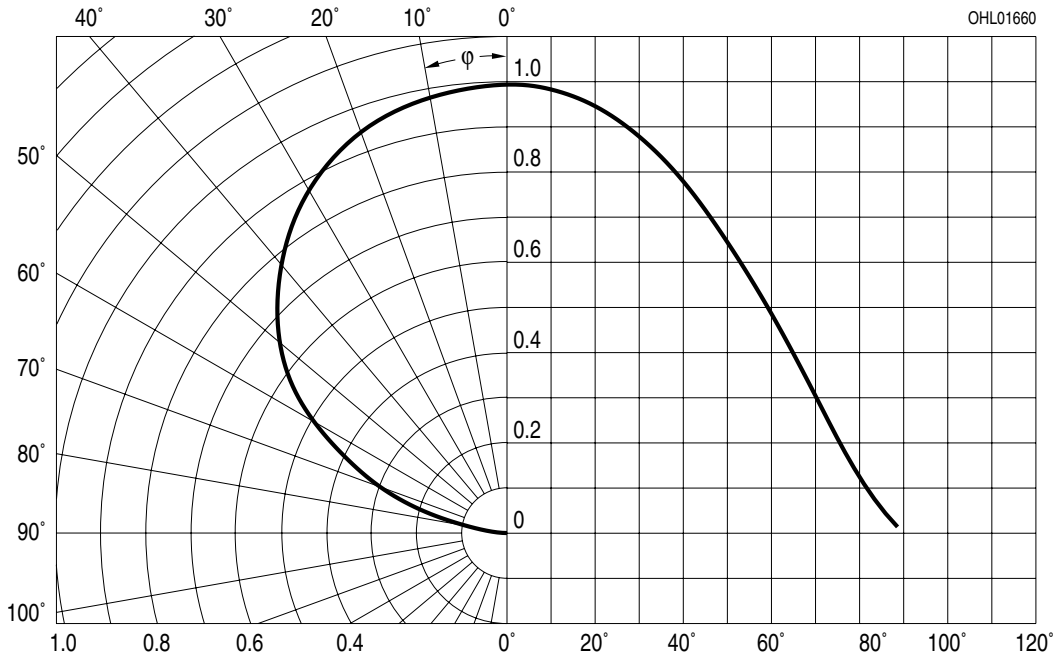

Forward current 8), 9)

$I_F = f(V_F)$; single pulse; $t_p = 100 \mu s$

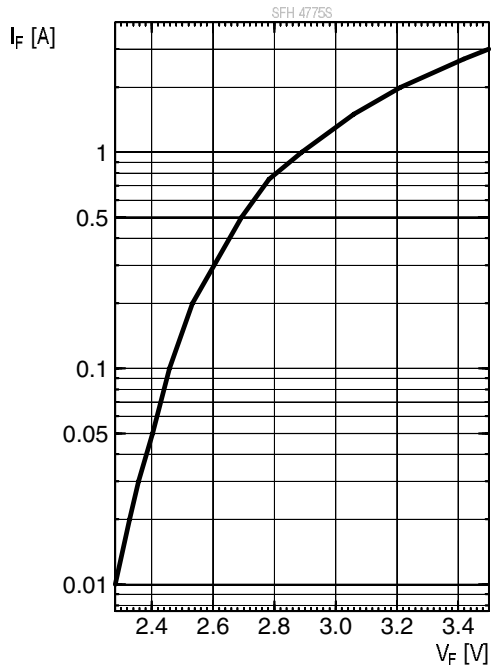

Relative Total Radiant Flux 8), 9)

$\Phi_e / \Phi_e(1000mA) = f(I_F)$; single pulse; $t_p = 100 \mu s$

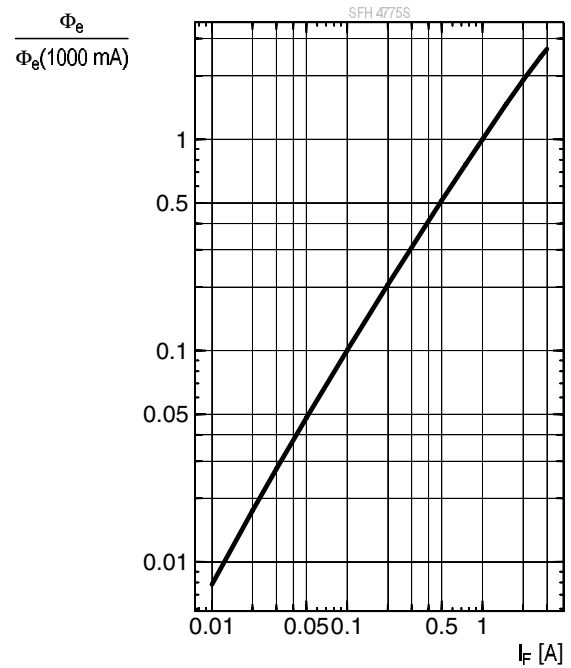

Max. Permissible Forward Current

$I_F = f(T_S)$; $R_{th_{js}} = 9 \text{ K/W}$

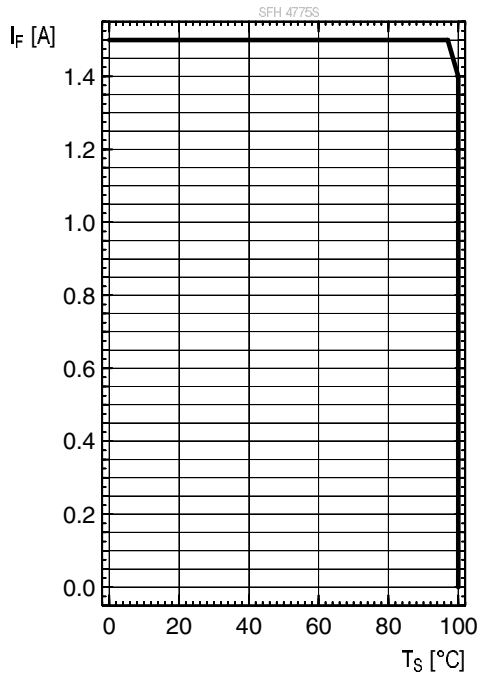

Permissible Pulse Handling Capability

$I_F = f(t_p)$; duty cycle $D = \text{parameter}$; $T_S = 85^\circ\text{C}$

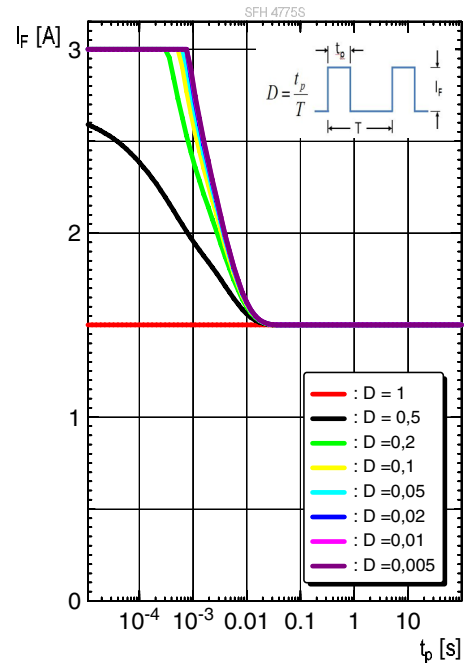

Dimensional Drawing ¹⁰⁾

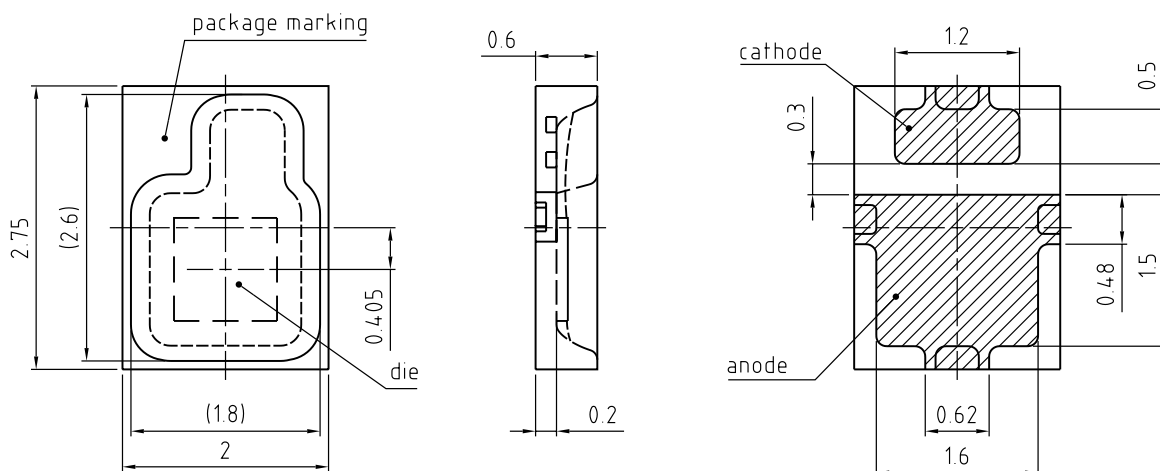

General tolerance ± 0.1

Lead finish Au 

C67062-A0183-A1-02

Further Information:

Approximate Weight: 12.0 mg

Package marking: Cathode

ESD advice: The device is protected by ESD device which is connected in parallel to the Chip.

Recommended Solder Pad ¹⁰⁾

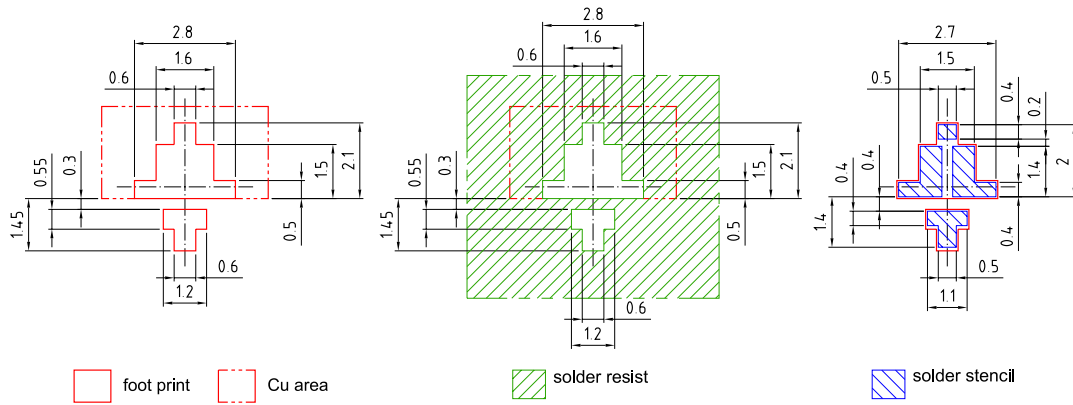

Component Location on Pad

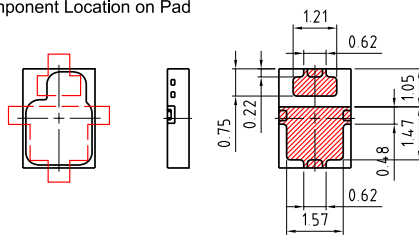

E062.3010.181 -02

Reflow Soldering Profile

Product complies to MSL Level 2 acc. to JEDEC J-STD-020E

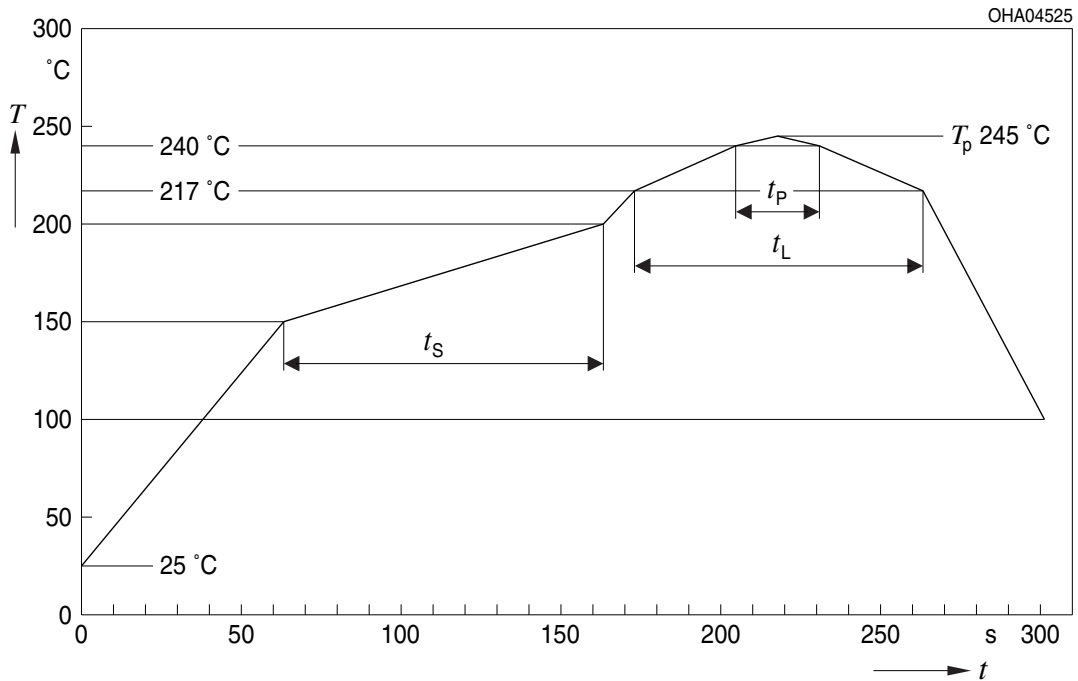

| Profile Feature | Symbol | Pb-Free (SnAgCu) Assembly | | | Unit |
|--|--------|---------------------------|----------------|---------|------|
| | | Minimum | Recommendation | Maximum | |
| Ramp-up rate to preheat ^{*)} 25 °C to 150 °C | | | 2 | 3 | K/s |
| Time t_s T_{Smin} to T_{Smax} | t_s | 60 | 100 | 120 | s |
| Ramp-up rate to peak ^{*)} T_{Smax} to T_p | | | 2 | 3 | K/s |
| Liquidus temperature | T_L | | 217 | | °C |
| Time above liquidus temperature | t_L | | 80 | 100 | s |
| Peak temperature | T_p | | 245 | 260 | °C |
| Time within 5 °C of the specified peak temperature $T_p - 5$ K | t_p | 10 | 20 | 30 | s |
| Ramp-down rate* T_p to 100 °C | | | 3 | 6 | K/s |
| Time 25 °C to T_p | | | | 480 | s |

All temperatures refer to the center of the package, measured on the top of the component

* slope calculation DT/Dt : Dt max. 5 s; fulfillment for the whole T-range

Taping ¹⁰⁾

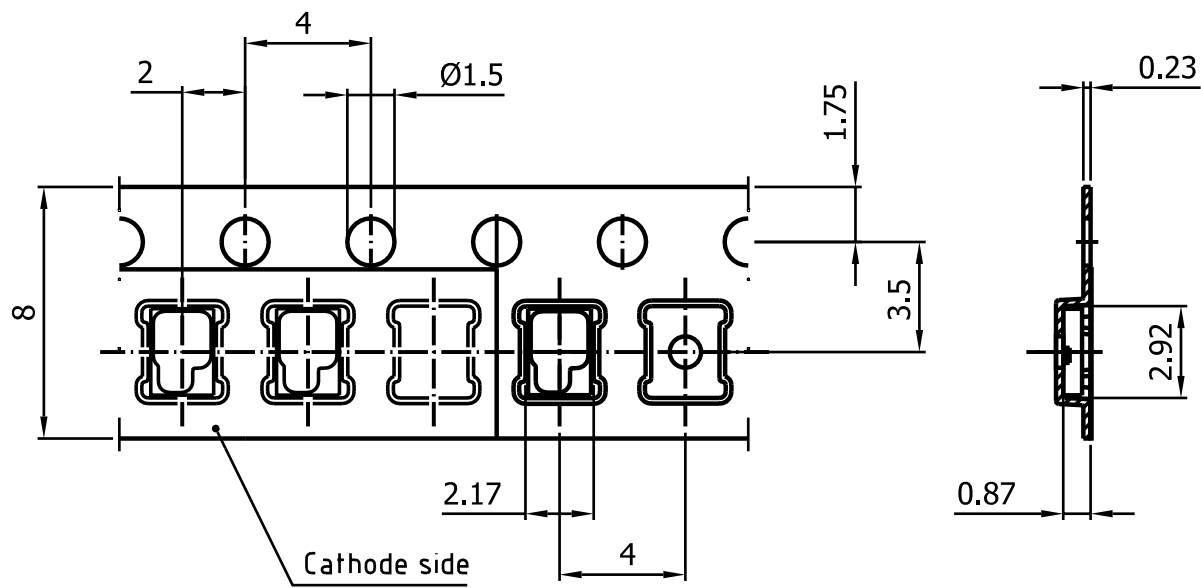

C67062-A0116-B14-04

Tape and Reel ¹¹⁾

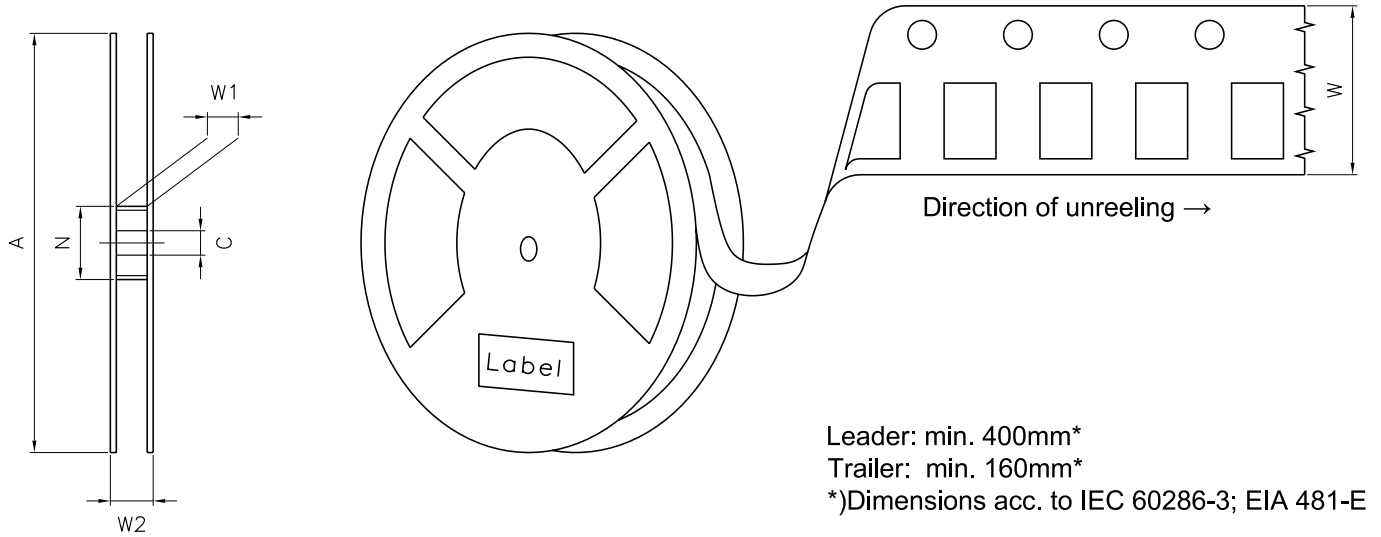

Reel Dimensions

| A | W | N_{\min} | W_1 | $W_{2\max}$ | Pieces per PU |
|--------|----------------------|------------|--------------|-------------|---------------|
| 180 mm | $8 + 0.3 / - 0.1$ mm | 60 mm | $8.4 + 2$ mm | 14.4 mm | 2000 |

Barcode-Product-Label (BPL)

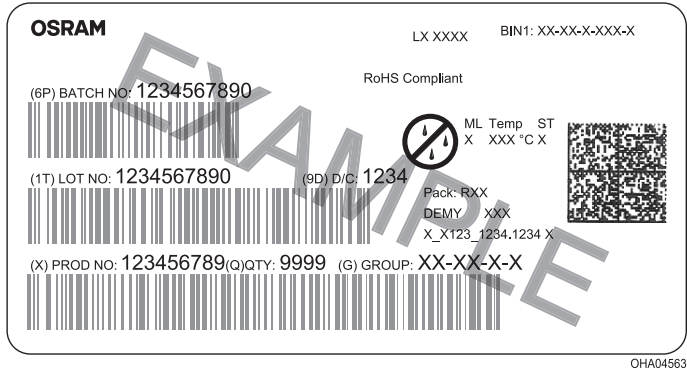

Dry Packing Process and Materials ¹⁰⁾

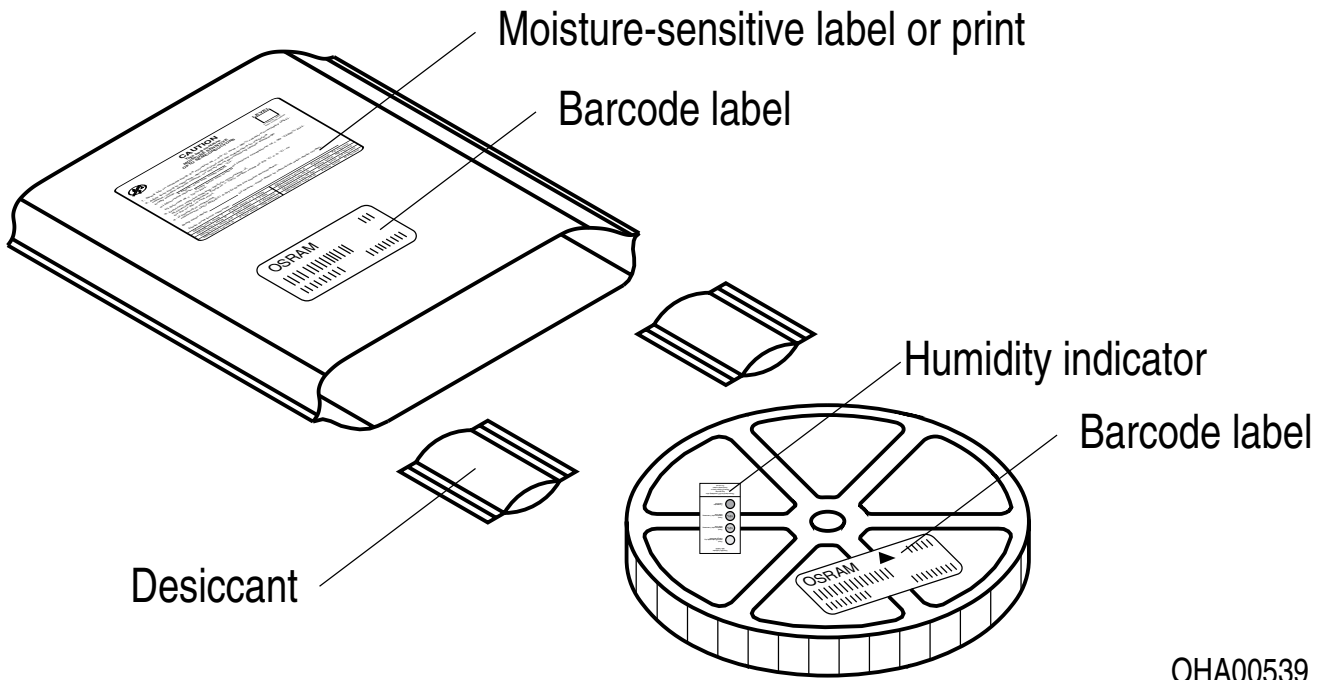

Moisture-sensitive product is packed in a dry bag containing desiccant and a humidity card according JEDEC-STD-033.

Notes

The evaluation of eye safety occurs according to the standard IEC 62471:2006 (photo biological safety of lamps and lamp systems). Within the risk grouping system of this IEC standard, the device specified in this data sheet falls into **exempt risk group - Exempt**.

Subcomponents of this device contain, in addition to other substances, metal filled materials including silver. Metal filled materials can be affected by environments that contain traces of aggressive substances. Therefore, we recommend that customers minimize device exposure to aggressive substances during storage, production, and use. Devices that showed visible discoloration when tested using the described tests above did show no performance deviations within failure limits during the stated test duration. Respective failure limits are described in the IEC60810.

For further application related information please visit <https://ams-osram.com/support/application-notes>

Disclaimer

Attention please!

The information describes the type of component and shall not be considered as assured characteristics. Terms of delivery and rights to change design reserved. Due to technical requirements components may contain dangerous substances.

For information on the types in question please contact our Sales Organization.

If printed or downloaded, please find the latest version on our website.

Packing

Please use the recycling operators known to you. We can also help you – get in touch with your nearest sales office. By agreement we will take packing material back, if it is sorted. You must bear the costs of transport. For packing material that is returned to us unsorted or which we are not obliged to accept, we shall have to invoice you for any costs incurred.

Product and functional safety devices/applications or medical devices/applications

Our components are not developed, constructed or tested for the application as safety relevant component or for the application in medical devices.

Our products are not qualified at module and system level for such application.

In case buyer – or customer supplied by buyer – considers using our components in product safety devices/ applications or medical devices/applications, buyer and/or customer has to inform our local sales partner immediately and we and buyer and /or customer will analyze and coordinate the customer-specific request between us and buyer and/or customer.

Glossary

- 1) **Total radiant flux:** Measured with integrating sphere.
- 2) **Brightness:** The brightness values are measured with a tolerance of $\pm 11\%$.
- 3) **Reverse Operation:** This product is intended to be operated applying a forward current within the specified range. Applying any continuous reverse bias or forward bias below the voltage range of light emission shall be avoided because it may cause migration which can change the electro-optical characteristics or damage the LED.
- 4) **Wavelength:** The wavelengths are measured with a tolerance of ± 1 nm.
- 5) **Forward Voltage:** The forward voltages are measured with a tolerance of ± 0.1 V.
- 6) **Radiant intensity:** Measured at a solid angle of $\Omega = 0.01$ sr
- 7) **Thermal resistance:** junction - soldering point, of the device only, mounted on an ideal heatsink (e.g. metal block)
- 8) **Typical Values:** Due to the special conditions of the manufacturing processes of semiconductor devices, the typical data or calculated correlations of technical parameters can only reflect statistical figures. These do not necessarily correspond to the actual parameters of each single product, which could differ from the typical data and calculated correlations or the typical characteristic line. If requested, e.g. because of technical improvements, these typ. data will be changed without any further notice.
- 9) **Testing temperature:** TA = 25°C (unless otherwise specified)
- 10) **Tolerance of Measure:** Unless otherwise noted in drawing, tolerances are specified with ± 0.1 and dimensions are specified in mm.
- 11) **Tape and Reel:** All dimensions and tolerances are specified acc. IEC 60286-3 and specified in mm.

Revision History

| Version | Date | Change |
|---------|------------|--|
| 1.1 | 2020-01-28 | Brightness and Wavelength Groups |
| 1.2 | 2020-08-26 | Schematic Transportation Box Dimensions of Transportation Box |
| 1.3 | 2021-04-06 | Notes |
| 1.4 | 2021-09-15 | Ordering Information Maximum Ratings Characteristics Electro - Optical Characteristics (Diagrams) |
| 1.5 | 2023-03-31 | New Layout Applications Characteristics |
| 1.6 | 2023-04-05 | Characteristics |
| 1.7 | 2023-10-04 | Ordering Information Electro - Optical Characteristics (Diagrams) |



EU RoHS and China RoHS compliant product

此产品符合欧盟 RoHS 指令的要求；
按照中国的相关法规和标准，
不含有毒有害物质或元素。

Published by ams-OSRAM AG

Tobelbader Strasse 30, 8141 Premstaetten, Austria

Phone +43 3136 500-0

ams-osram.com

© All rights reserved

am 

OSRAM