

OSRAM SFH 41847BS

Datasheet

Published by **ams-OSRAM AG**

Tobelbader Strasse 30, 8141 Premstaetten, Austria

Phone +43 3136 500-0

ams-osram.com

© All rights reserved



OSLON™ P1616 Lens

SFH 41847BS

OSRAM OSLON™ P1616, SFH 41847BS offers outstanding brightness up to 1565 mW using IR:6 thin-film chip technology for IREDs in an exceptionally small package with a footprint of only 1.6 × 1.6 mm. The rectangular light pattern matches sensor arrays and camera fields of view, concentrating illumination where it matters and minimizing light waste. Emitting at 940 nm, it is ideal for applications requiring reduced red glow compared to 850 nm, such as face authentication and security cameras. Thermally stable and energy efficient, the device is optimized for reliable long-term operation in demanding environments.

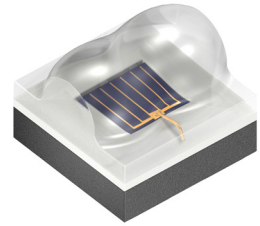

Applications

- Access control & security
- Authentication
- Eye, face and hand tracking
- Factory automation
- Home & building automation
- Medical lighting

Features

- Package: clear silicone
- ESD: 2 kV acc. to ANSI/ESDA/JEDEC JS-001 (HBM)
- IR lightsource with high efficiency
- Double stack emitter

Ordering Information

| Type | Radiant intensity ¹⁾²⁾ $I_F = 1 \text{ A}; t_p = 10 \text{ ms}$ I_e | Radiant intensity ¹⁾ typ. $I_F = 1 \text{ A}; t_p = 10 \text{ ms}$ I_e | Ordering Code |
|-------------------------|----------------------------------------------------------------------------------------|----------------------------------------------------------------------------------------------|---------------|
| SFH 41847BS-CA2DA1-1113 | 320 ... 500 mW/sr | 380 mW/sr | Q65113A9145 |
| SFH 41847BS-CA2DA1-13 | 320 ... 500 mW/sr | 380 mW/sr | Q65113A9144 |

Maximum Ratings

$T_A = 25\text{ °C}$

| Parameter | Symbol | Values | |
|------------------------------------------------------------------------|----------------|--------|---------|
| Operating temperature | T_{op} | min. | -40 °C |
| | | max. | 105 °C |
| Storage temperature | T_{stg} | min. | -40 °C |
| | | max. | 105 °C |
| Junction temperature | T_j | max. | 145 °C |
| Forward current | I_F | max. | 1000 mA |
| Forward current pulsed $t_p \leq 600\ \mu\text{s}$; $D \leq 0.005$ | $I_{F\ pulse}$ | max. | 2 A |
| Reverse voltage ³⁾ | V_R | max. | 5 V |
| ESD withstand voltage acc. to ANSI/ESDA/JEDEC JS-001 (HBM) | V_{ESD} | max. | 2 kV |

Note: For the forward current and power consumption please see maximum permissible forward current diagram.

Characteristics

$I_F = 1000 \text{ mA}$; $t_p = 10 \text{ ms}$; $T_A = 25 \text{ °C}$

| Parameter | Symbol | Values | |
|----------------------------------------------------------------------------------------------------------------|-----------------------------|--------|---------------------|
| Peak wavelength | λ_{peak} | typ. | 950 nm |
| Centroid wavelength ⁴⁾ | $\lambda_{\text{centroid}}$ | min. | 912 nm |
| | | typ. | 940 nm |
| | | max. | 950 nm |
| Spectral bandwidth at 50% $I_{\text{rel,max}}$ (FWHM) | $\Delta\lambda$ | typ. | 37 nm |
| Half angle horizontal | φ | typ. | 50 ° |
| Half angle vertical | φ | typ. | 70 ° |
| Dimensions of chip area | L x W | typ. | 0.73 x 0.73 mm x mm |
| Rise time (10% / 90%) $I_F = 2 \text{ A}$; $R_L = 5 \text{ } \Omega$ | t_r | typ. | 9 ns |
| Fall time (10% / 90%) $I_F = 2 \text{ A}$; $R_L = 5 \text{ } \Omega$ | t_f | typ. | 16 ns |
| Forward voltage ⁵⁾ | V_F | typ. | 2.8 V |
| | | max. | 3.2 V |
| Forward voltage ⁵⁾ $I_F = 2 \text{ A}$; $t_p = 100 \text{ } \mu\text{s}$ | V_F | typ. | 3.0 V |
| | | max. | 3.7 V |
| Reverse current ³⁾ | I_R | typ. | 0.01 μA |
| | | max. | 10 μA |
| Total radiant flux ⁶⁾ $I_F = 1 \text{ A}$; $t_p = 10 \text{ ms}$ | Φ_e | typ. | 1565 mW |
| Thermal resistance junction solder point electrical ⁷⁾ with efficiency $\eta_e = 56 \text{ } \%$ | $R_{\text{thJS elec.}}$ | typ. | 5.7 K / W |
| | | max. | 7.0 K / W |
| Thermal resistance junction solder point real ⁷⁾ | $R_{\text{thJS real}}$ | typ. | 13.0 K / W |
| | | max. | 16.0 K / W |

Brightness Groups

| Group | Radiant intensity ¹⁾²⁾ $I_F = 1 \text{ A}; t_p = 10 \text{ ms}$ min. | Radiant intensity ¹⁾²⁾ $I_F = 1 \text{ A}; t_p = 10 \text{ ms}$ max. |
|-------|---------------------------------------------------------------------------------------|---------------------------------------------------------------------------------------|
| | I_e | I_e |
| CA2 | 320 mW/sr | 355 mW/sr |
| CB1 | 355 mW/sr | 400 mW/sr |
| CB2 | 400 mW/sr | 450 mW/sr |
| DA1 | 450 mW/sr | 500 mW/sr |

Centroid Wavelength

| Group | Centroid wavelength ⁴⁾ $I_F = 1 \text{ A}; t_p = 10 \text{ ms}$ min. | Centroid wavelength ⁴⁾ $I_F = 1 \text{ A}; t_p = 10 \text{ ms}$ max. |
|-------|---------------------------------------------------------------------------------------|---------------------------------------------------------------------------------------|
| | $\lambda_{\text{centroid}}$ | $\lambda_{\text{centroid}}$ |
| 11 | 912 nm | 925 nm |
| 12 | 925 nm | 930 nm |
| 13 | 930 nm | 950 nm |

Relative Spectral Emission 8), 9)

Centroid wavelength 920nm

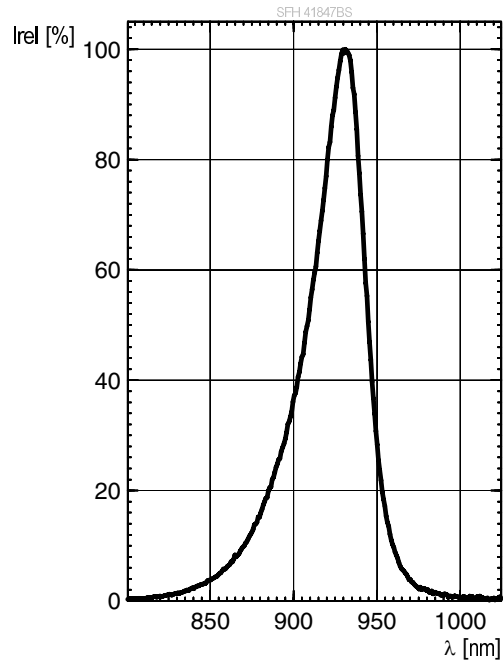

Relative Spectral Emission 8), 9)

Centroid wavelength 940nm

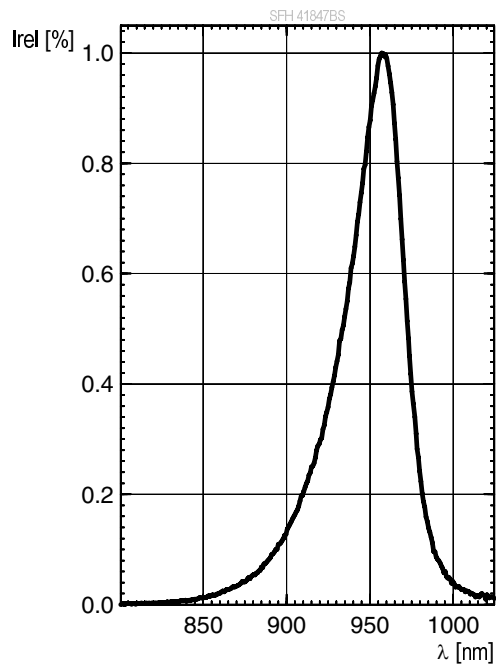

Radiation Characteristics 8), 9)

$I_{e,rel} = f(\varphi)$

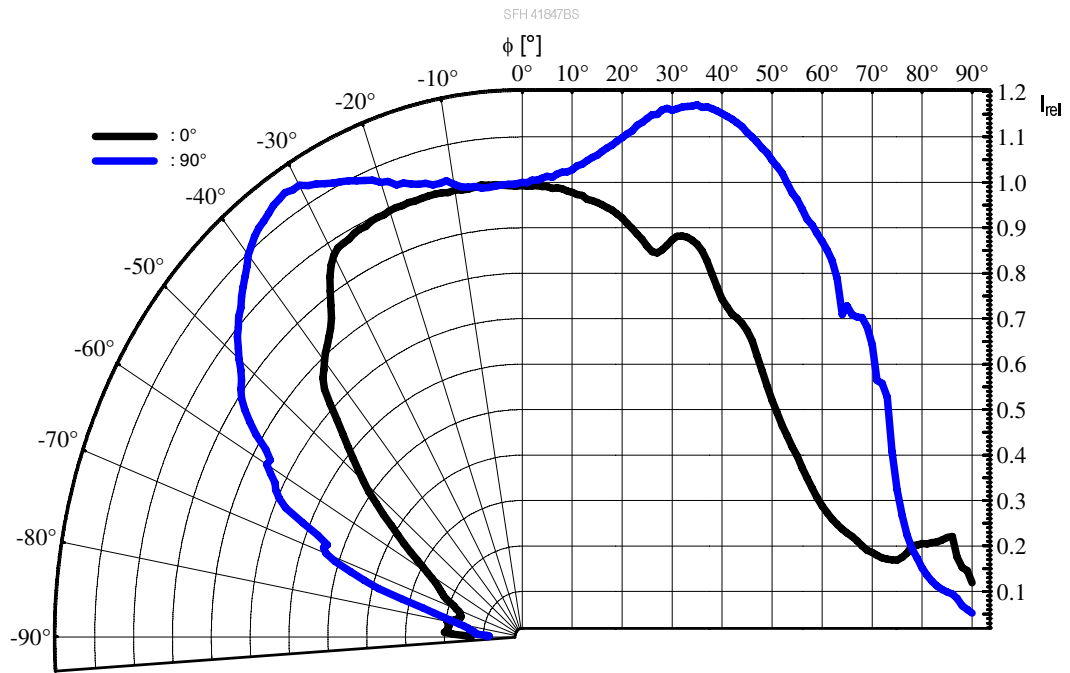

Forward current ^{8), 9)}

$I_F = f(V_F)$; single pulse; $t_p = 100 \mu s$

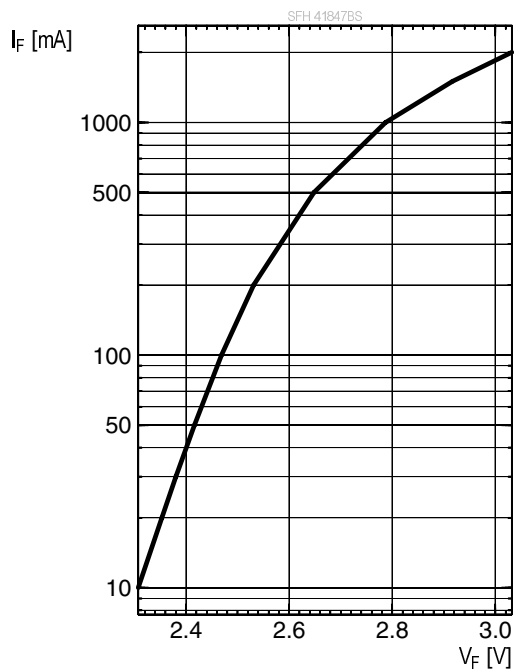

Relative Total Radiant Flux ^{8), 9)}

$\Phi_e / \Phi_e(1000 \text{mA}) = f(I_F)$; single pulse; $t_p = 100 \mu s$

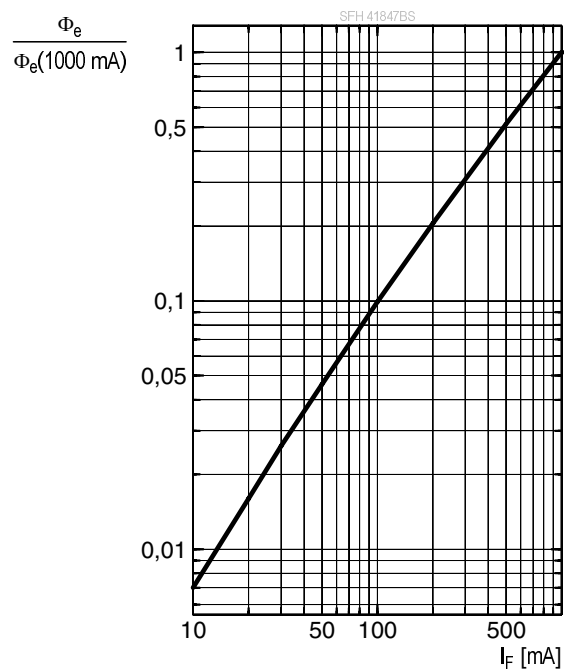

Relative Total Radiant Flux ⁸⁾

$$\Phi_{\text{rel}} = f(T_S); I_F = 1\text{A}; t_p = 100\mu\text{s}$$

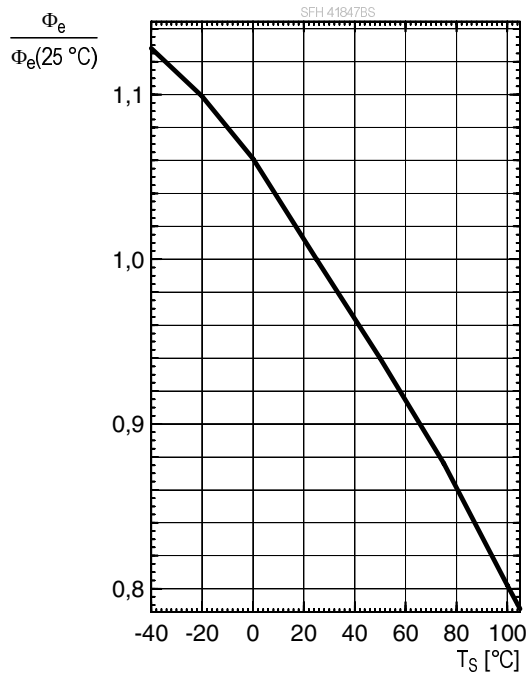

Forward Voltage ⁸⁾

$$V_F = f(T_S); I_F = 1\text{A}; t_p = 100\mu\text{s}$$

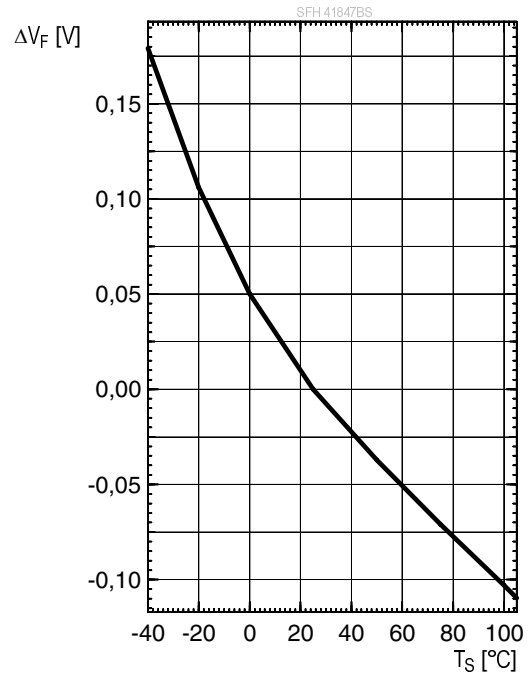

Centroid Wavelength ⁸⁾

$$\lambda_{\text{centroid}} = f(T_S); I_F = 1\text{A}; t_p = 100\mu\text{s}$$

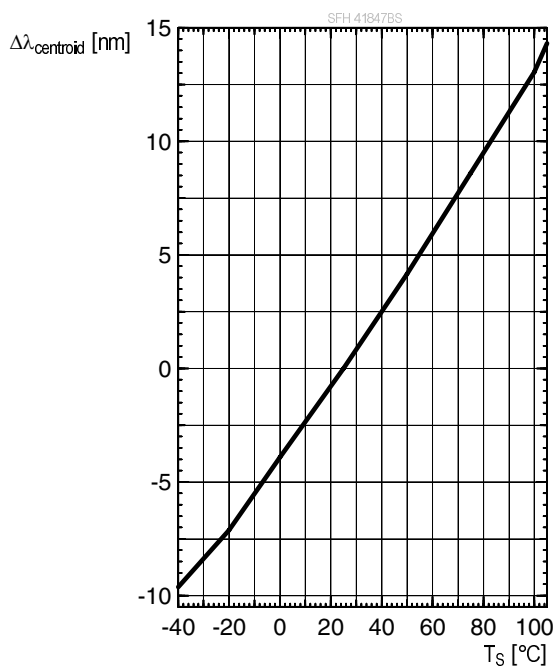

Max. Permissible Forward Current

$$I_F = f(T_S); R_{th_{js}} = 16 \text{ K/W}$$

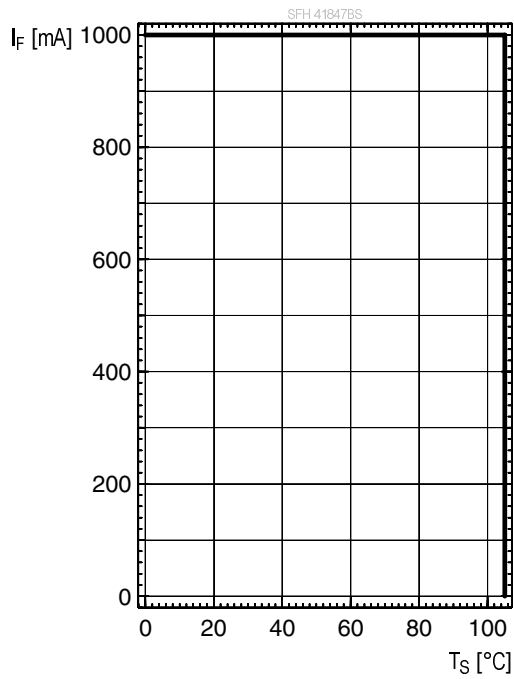

Permissible Pulse Handling Capability

$$I_F = f(t_p); D = \text{parameter}; T_S = 85 \text{ °C}$$

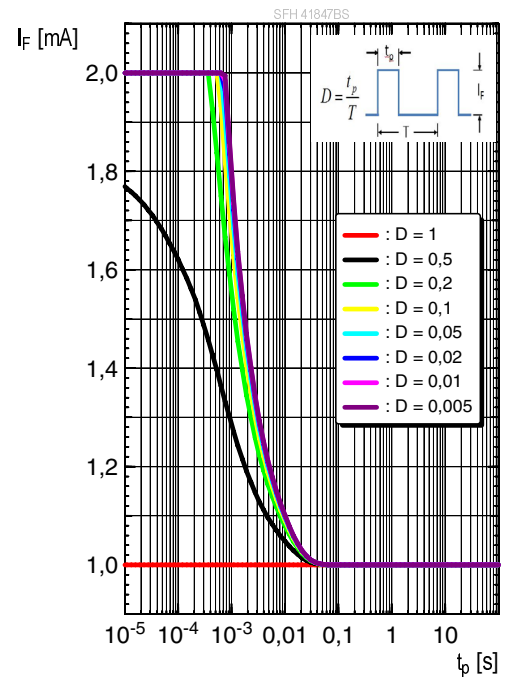

Dimensional Drawing ¹⁰⁾

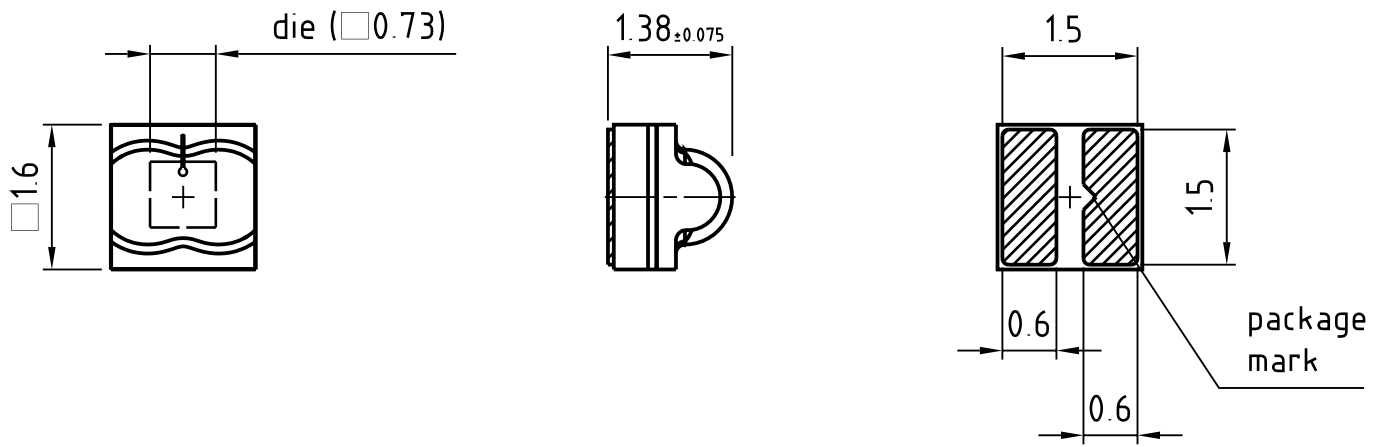

C69062-A0046-A1.01

Further Information:

Approximate Weight: 7.0 mg

Package marking: Cathode

Recommended Solder Pad ¹⁰⁾

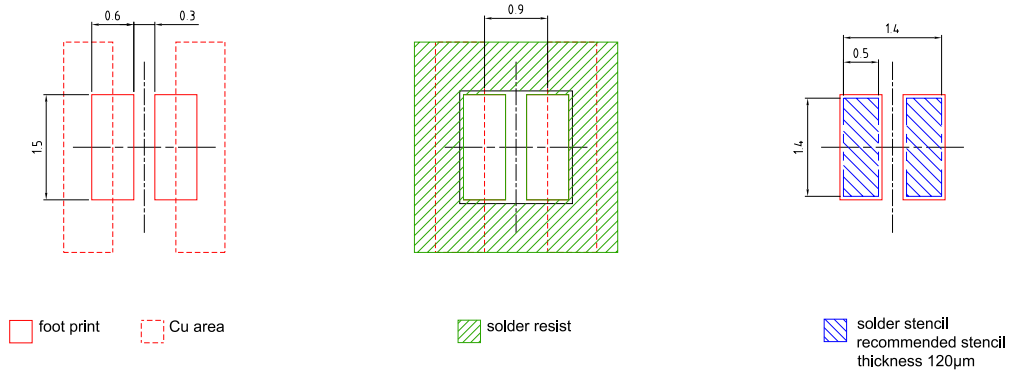

Component Location on Pad



E062.3010.272 -02

Reflow Soldering Profile

Product complies to MSL Level 2 acc. to JEDEC J-STD-020E

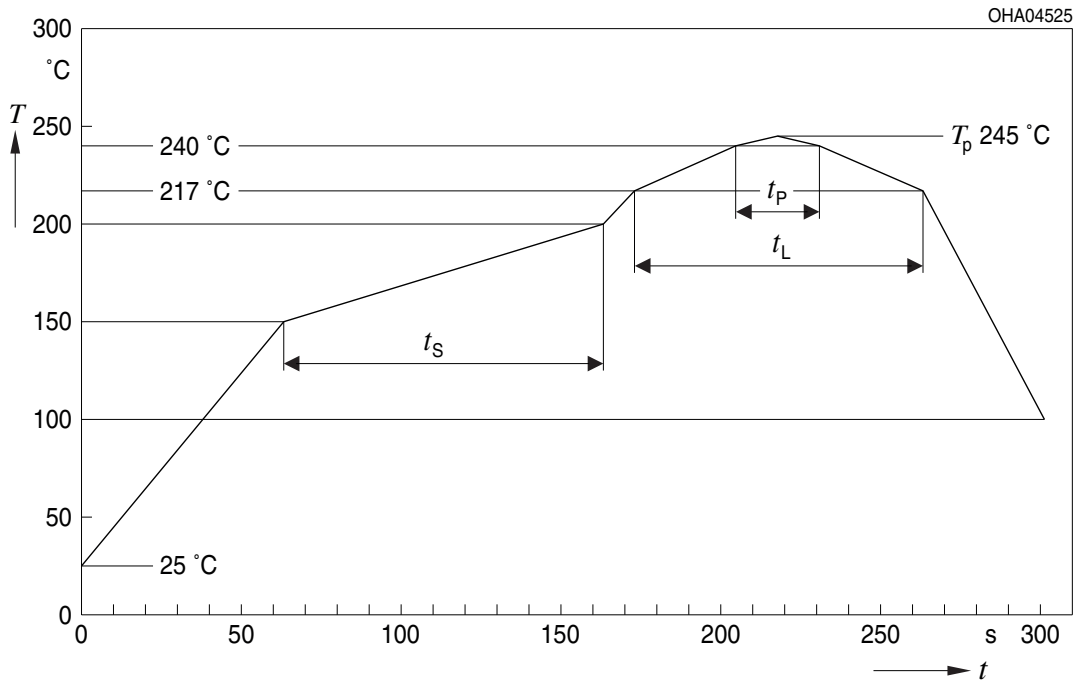

| Profile Feature | Symbol | Pb-Free (SnAgCu) Assembly | | | Unit |
|----------------------------------------------------------------|--------|---------------------------|----------------|---------|------|
| | | Minimum | Recommendation | Maximum | |
| Ramp-up rate to preheat ^{*)} 25 °C to 150 °C | | | 2 | 3 | K/s |
| Time t_s T_{Smin} to T_{Smax} | t_s | 60 | 100 | 120 | s |
| Ramp-up rate to peak ^{*)} T_{Smax} to T_p | | | 2 | 3 | K/s |
| Liquidus temperature | T_L | | 217 | | °C |
| Time above liquidus temperature | t_L | | 80 | 100 | s |
| Peak temperature | T_p | | 245 | 260 | °C |
| Time within 5 °C of the specified peak temperature $T_p - 5$ K | t_p | 10 | 20 | 30 | s |
| Ramp-down rate* T_p to 100 °C | | | 3 | 6 | K/s |
| Time 25 °C to T_p | | | | 480 | s |

All temperatures refer to the center of the package, measured on the top of the component

* slope calculation DT/Dt : Dt max. 5 s; fulfillment for the whole T-range

Taping ¹⁰⁾

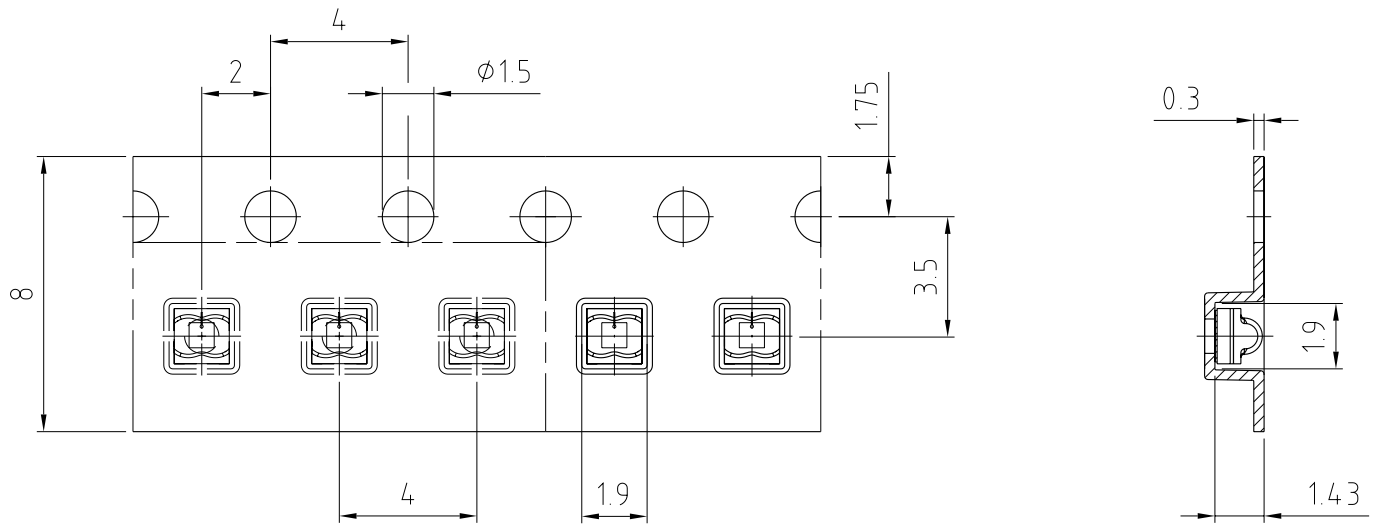

C69062-A0046-B5-02

Tape and Reel ¹¹⁾

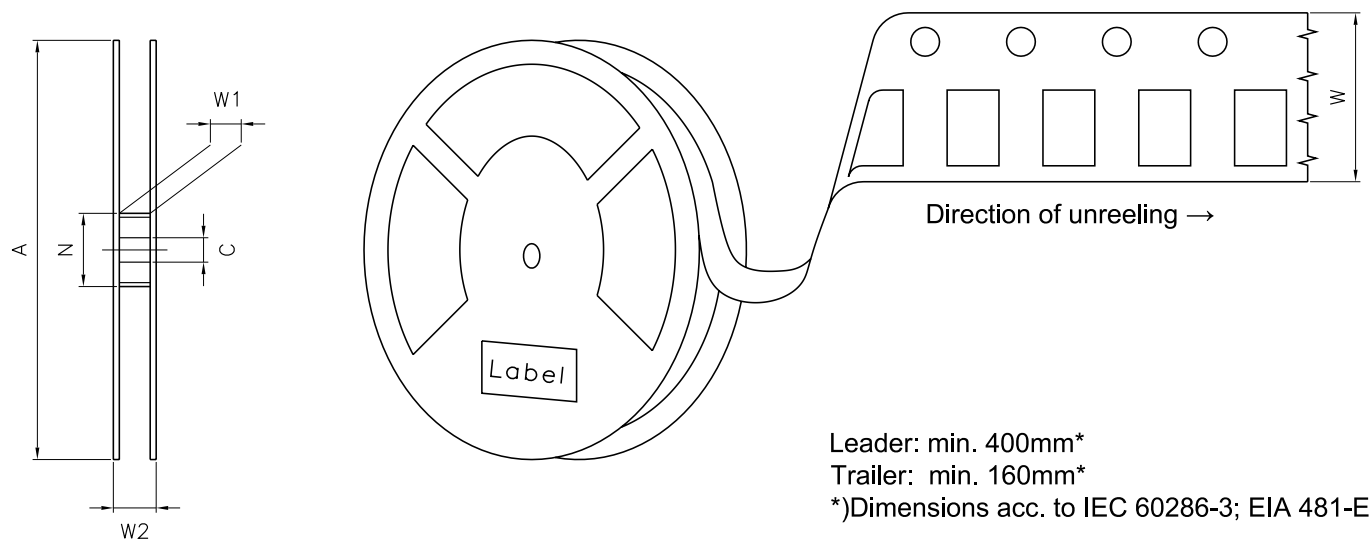

Reel Dimensions

| A | W | N_{\min} | W_1 | $W_{2\max}$ | Pieces per PU |
|--------|----------------------|------------|--------------|-------------|---------------|
| 180 mm | $8 + 0.3 / - 0.1$ mm | 60 mm | $8.4 + 2$ mm | 14.4 mm | 3000 |

Barcode-Product-Label (BPL)

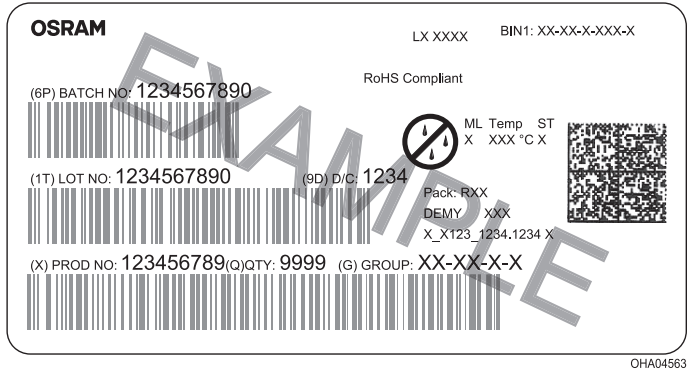

Dry Packing Process and Materials

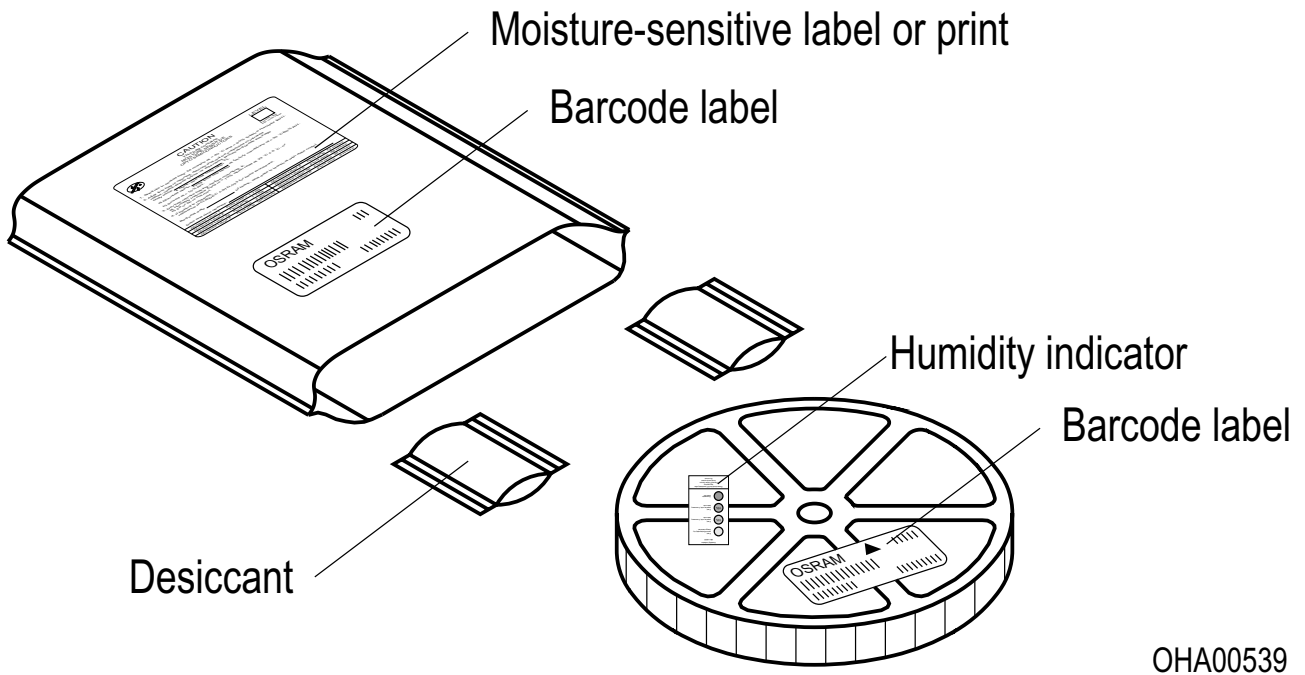

Moisture-sensitive product is packed in a dry bag containing desiccant and a humidity card according JEDEC-STD-033.

Notes

The evaluation of eye safety occurs according to the standard IEC 62471:2006 (photo biological safety of lamps and lamp systems). Within the risk grouping system of this IEC standard, the device specified in this data sheet falls into **exempt risk group - Exempt**.

Subcomponents of this device contain, in addition to other substances, metal filled materials including silver. Metal filled materials can be affected by environments that contain traces of aggressive substances. Therefore, we recommend that customers minimize device exposure to aggressive substances during storage, production, and use. Devices that showed visible discoloration when tested using the described tests above did show no performance deviations within failure limits during the stated test duration. Respective failure limits are described in the IEC60810.

Handling:

Solvents, water, liquids, non-conductive plastics and glues are not allowed near the device, because solvents and other liquids could emerge and damage the product.

For further application related information please visit <https://ams-osram.com/support/application-notes>

Disclaimer

Attention please!

The information describes the type of component and shall not be considered as assured characteristics. Terms of delivery and rights to change design reserved. Due to technical requirements components may contain dangerous substances.

For information on the types in question please contact our Sales Organization.

If printed or downloaded, please find the latest version on our website.

Packing

Please use the recycling operators known to you. We can also help you – get in touch with your nearest sales office. By agreement we will take packing material back, if it is sorted. You must bear the costs of transport. For packing material that is returned to us unsorted or which we are not obliged to accept, we shall have to invoice you for any costs incurred.

Product and functional safety devices/applications or medical devices/applications

Our components are not developed, constructed or tested for the application as safety relevant component or for the application in medical devices.

Our products are not qualified at module and system level for such application.

In case buyer – or customer supplied by buyer – considers using our components in product safety devices/ applications or medical devices/applications, buyer and/or customer has to inform our local sales partner immediately and we and buyer and /or customer will analyze and coordinate the customer-specific request between us and buyer and/or customer.

Glossary

- 1) **Radiant intensity:** Measured at a solid angle of $\Omega = 0.01$ sr
- 2) **Brightness:** The brightness values are measured with a tolerance of $\pm 11\%$.
- 3) **Reverse Operation:** This product is intended to be operated applying a forward current within the specified range. Applying any continuous reverse bias or forward bias below the voltage range of light emission shall be avoided because it may cause migration which can change the electro-optical characteristics or damage the LED.
- 4) **Wavelength:** The wavelengths are measured with a tolerance of ± 1 nm.
- 5) **Forward Voltage:** The forward voltages are measured with a tolerance of ± 0.1 V.
- 6) **Total radiant flux:** Measured with integrating sphere.
- 7) **Thermal resistance:** junction - soldering point, of the device only, mounted on an ideal heatsink (e.g. metal block)
- 8) **Typical Values:** Due to the special conditions of the manufacturing processes of semiconductor devices, the typical data or calculated correlations of technical parameters can only reflect statistical figures. These do not necessarily correspond to the actual parameters of each single product, which could differ from the typical data and calculated correlations or the typical characteristic line. If requested, e.g. because of technical improvements, these typ. data will be changed without any further notice.
- 9) **Testing temperature:** TA = 25°C (unless otherwise specified)
- 10) **Tolerance of Measure:** Unless otherwise noted in drawing, tolerances are specified with ± 0.1 and dimensions are specified in mm.
- 11) **Tape and Reel:** All dimensions and tolerances are specified acc. IEC 60286-3 and specified in mm.

Revision History

| Version | Date | Change |
|---------|------------|-------------------------------------------|
| 1.0 | 2025-10-13 | Initial Version |
| 1.1 | 2025-11-05 | Description |
| 1.2 | 2025-11-14 | Taping |
| 1.3 | 2026-06-10 | Ordering Information Wavelength Groups |



EU RoHS and China RoHS compliant product

此产品符合欧盟 RoHS 指令的要求；
按照中国的相关法规和标准，
不含有毒有害物质或元素。

Published by ams-OSRAM AG

Tobelbader Strasse 30, 8141 Premstaetten, Austria

Phone +43 3136 500-0

ams-osram.com

© All rights reserved

am 

OSRAM