

# OSRAM CN DELSS2.27

## Datasheet

Published by **ams-OSRAM AG**

Tobelbader Strasse 30, 8141 Premstaetten, Austria

Phone +43 3136 500-0

[ams-osram.com](http://ams-osram.com)

© All rights reserved



## FIREFLY™ E1608

# CN DELSS2.27

The FIREFLY E1608 family expands ams OSRAM's portfolio of products for use in mobile devices like fitness tracker, TWS earbuds and smart watch, and for health monitoring.

It offers one of the smallest LED footprints in a highly reliable and proven package. The compact size of only 0.8 mm x 1.6 mm x 0.6 mm provides customers the benefit of more flexible product designs. This IR device is the perfect choice for SpO2 measurements as well as for proximity sensing.

Additionally, the product is ideally suited for integration into rain sensors and therefore features the automotive qualification AEC-Q102.

Please check also our 940nm version as well as green and red Firefly E1608.



### Applications

- Appliances & tools
- Digital diagnostic devices
- Rain light tunnel sensing
- Vital sign monitoring

## Features

- Package: white SMT package, colorless clear resin
- Chip technology: IR Thinfilm
- Typ. Radiation: 120° (Lambertian emitter)
- Color:  $\lambda_{\text{centroid}} = 850 \text{ nm}$  (● infrared (850 nm))
- Corrosion Robustness Class: 2B
- Qualifications: AEC-Q102 Qualified
- ESD: 2 kV acc. to ANSI/ESDA/JEDEC JS-001 (HBM, Class 2)

## Ordering Information

Type	Radiant Intensity <sup>1)</sup> $I_F = 20 \text{ mA}$ $I_e$	Radiant intensity <sup>2)</sup> typ. $I_F = 20 \text{ mA}; t_p = 20 \text{ ms}$ $I_e$	Ordering Code
CN DELSS2.27	3.20 ... 4.60 mW/sr	3.7 mW/sr	Q65115A1092

## Maximum Ratings

Parameter	Symbol		Values
Operating Temperature	$T_{op}$	min.	-40 °C
		max.	110 °C
Storage Temperature	$T_{stg}$	min.	-40 °C
		max.	110 °C
Junction Temperature	$T_j$	max.	125 °C
Forward current $T_s = 25\text{ °C}$	$I_F$	min.	1 mA
		max.	100 mA
Forward current pulsed $t_p \leq 100\mu\text{s}; D = 0.005$	$I_{F\text{ pulse}}$	max.	1 A
Reverse voltage <sup>3)</sup> $T_s = 25\text{ °C}$	$V_R$	max.	5 V
ESD withstand voltage acc. to ANSI/ESDA/JEDEC JS-001 (HBM, Class 2)	$V_{ESD}$		2 kV

## Characteristics

$I_F = 20 \text{ mA}$ ;  $T_S = 25 \text{ °C}$

Parameter	Symbol		Values
Peak Wavelength	$\lambda_{\text{peak}}$	typ.	860 nm
Centroid Wavelength <sup>4)</sup> $I_F = 20 \text{ mA}$	$\lambda_{\text{centroid}}$	min. typ. max.	840 nm 850 nm 860 nm
Spectral bandwidth at 50% $I_{\text{rel,max}}$ <sup>5)</sup>	$\Delta\lambda$	max.	30 nm
Viewing angle at 50% $I_V$	$2\phi$	typ.	120 °
Forward Voltage <sup>6)</sup> $I_F = 20 \text{ mA}$	$V_F$	min. typ. max.	1.20 V 1.35 V 1.50 V
Reverse current <sup>3)</sup> $V_R = 5 \text{ V}$	$I_R$	typ. max.	0.01 $\mu\text{A}$ 10 $\mu\text{A}$
Real thermal resistance junction/solderpoint <sup>7)</sup>	$R_{\text{thJS real}}$	typ. max.	30 K / W 42 K / W
Radiant intensity <sup>2)8)</sup> $I_F = 20 \text{ mA}$ ; $t_p = 20 \text{ ms}$	$I_e$	min. typ. max.	3.2 mW/sr 3.7 mW/sr 4.6 mW/sr

### Relative Spectral Emission <sup>9), 10)</sup>

$$I_{e,rel} = f(\lambda); I_F = 20 \text{ mA}; t_p = 20 \text{ ms}$$

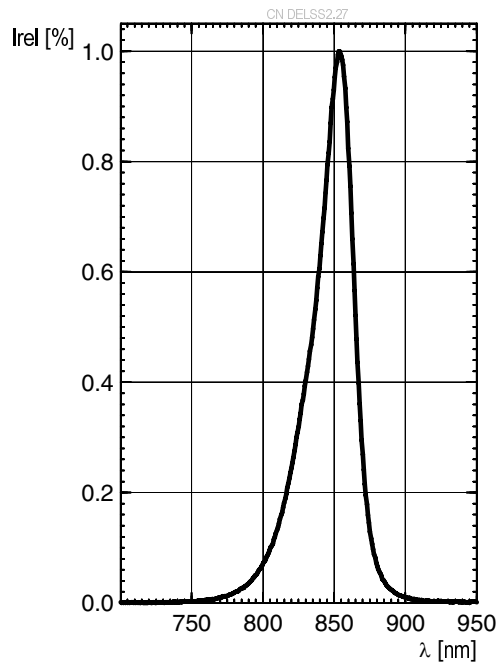

### Radiation Characteristics <sup>9), 10)</sup>

$$I_{rel} = f(\phi); T_S = 25 \text{ }^\circ\text{C}$$

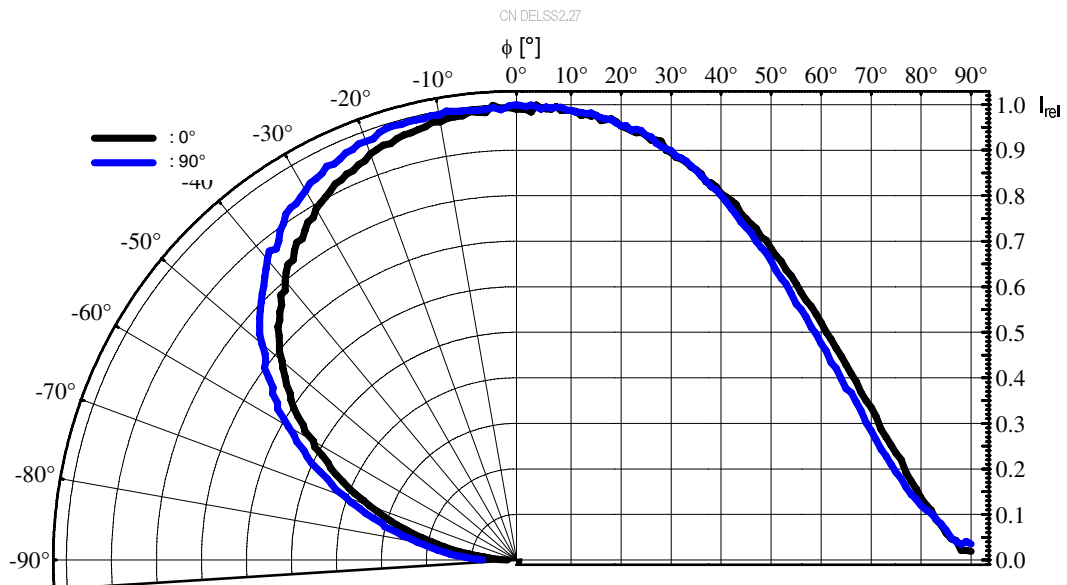

### Forward current <sup>9), 10)</sup>

$I_F = f(V_F)$ ; single pulse;  $t_p = 100 \mu s$

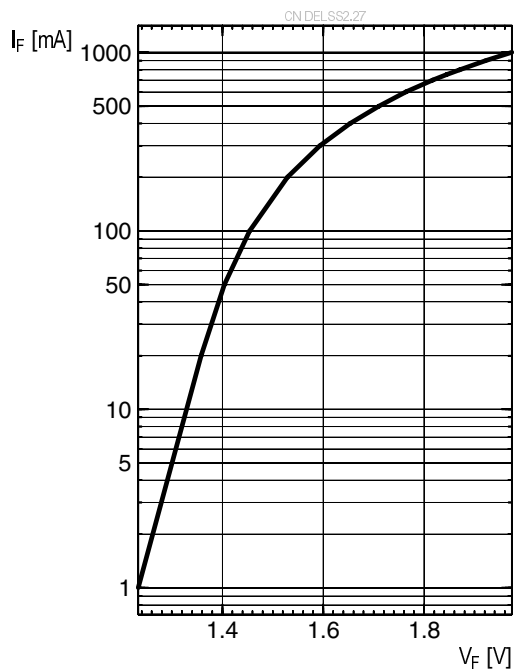

### Relative Radiant Intensity <sup>9), 10)</sup>

$I_e/I_e(20mA) = f(I_F)$ ; single pulse;  $t_p = 100 \mu s$

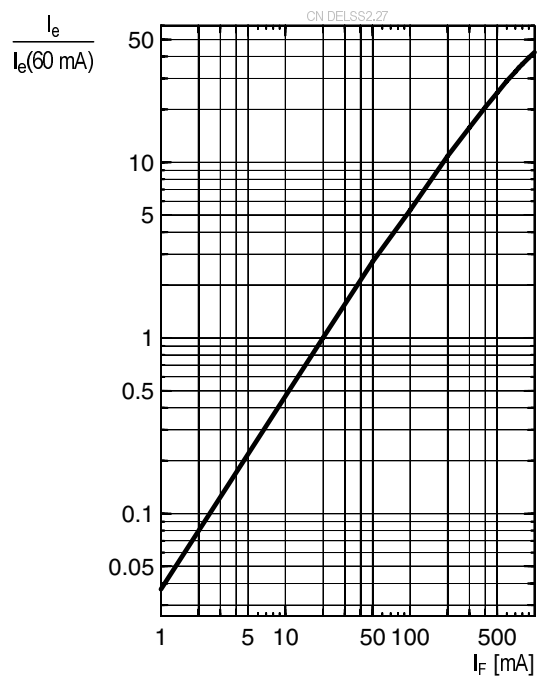

### Relative Radiant Intensity <sup>9)</sup>

$$I_E/I_E(25\text{ }^\circ\text{C}) = f(T_j); I_F = 20\text{ mA}$$

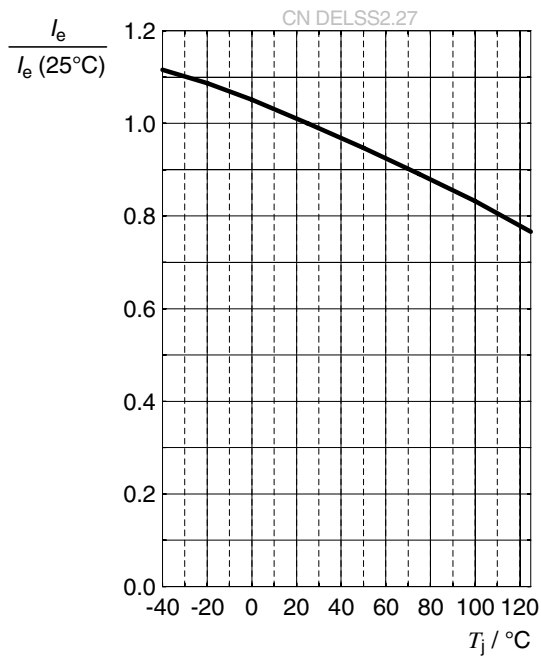

### Forward Voltage <sup>9)</sup>

$$V_F = f(T_s); I_F = 20\text{ mA}; t_p = 20\text{ ms}$$

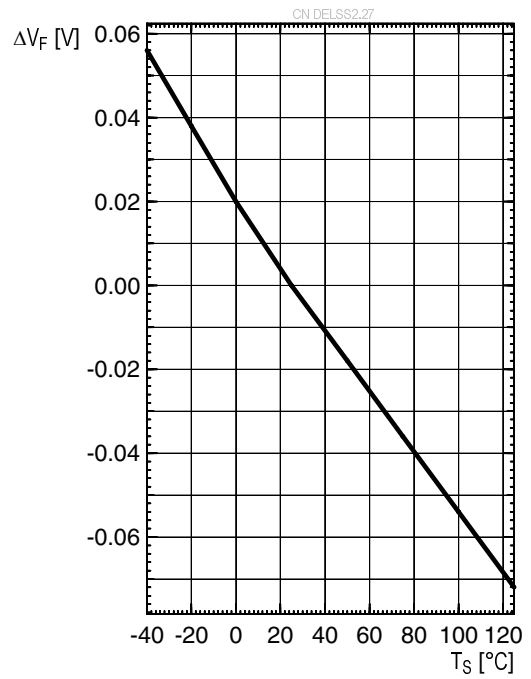

### Centroid Wavelength <sup>9)</sup>

$$\lambda_{\text{centroid}} = f(T_s); I_F = 20\text{ mA}; t_p = 20\text{ ms}$$

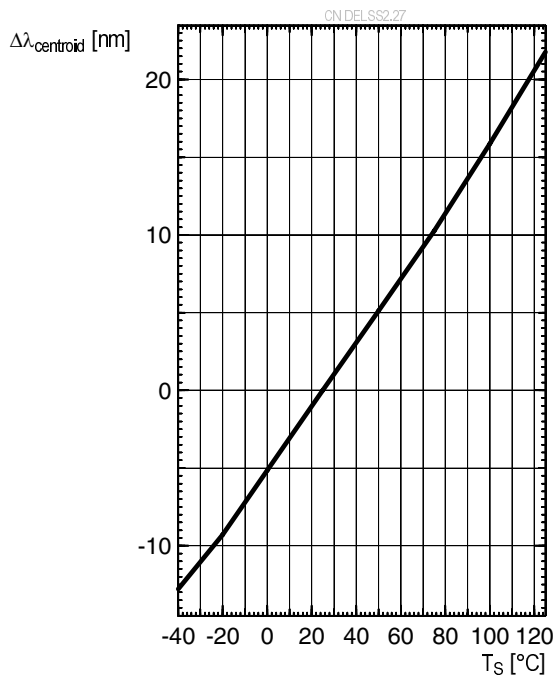

### Max. Permissible Forward Current

$I_F = f(T_S)$ ;  $R_{th_{js}} = 42 \text{ K/W}$

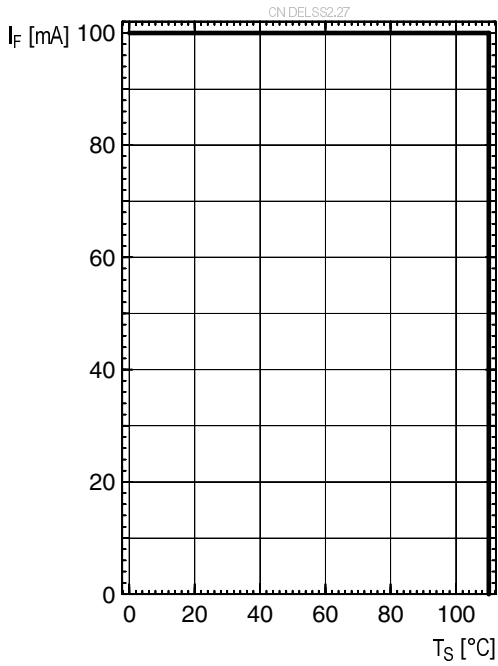

### Permissible Pulse Handling Capability

$I_F = f(t_p)$ ; duty cycle  $D = \text{parameter}$ ;  $T_S = 85^\circ\text{C}$

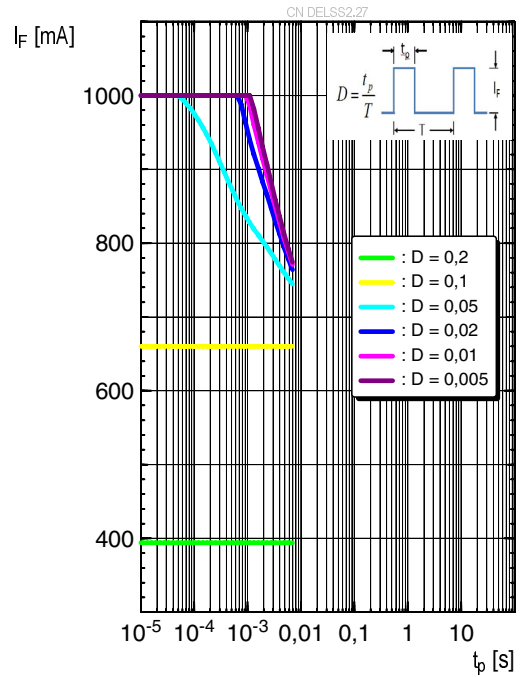

### Permissible Pulse Handling Capability

$I_F = f(t_p)$ ;  $D = \text{parameter}$ ;  $T_S = 110^\circ\text{C}$

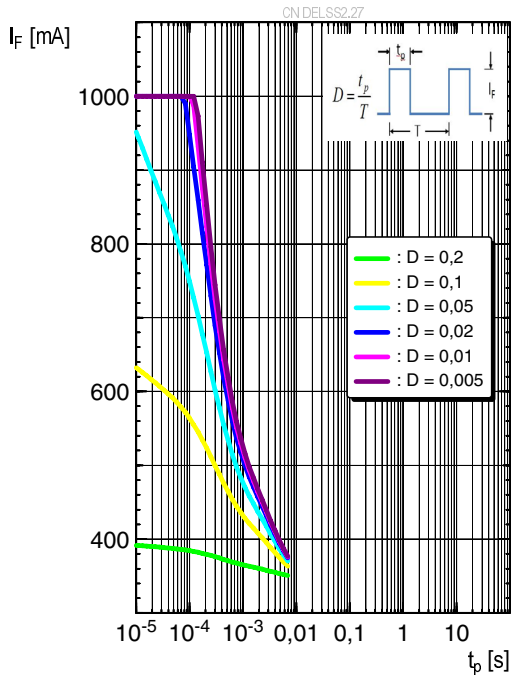

Dimensional Drawing <sup>11)</sup>

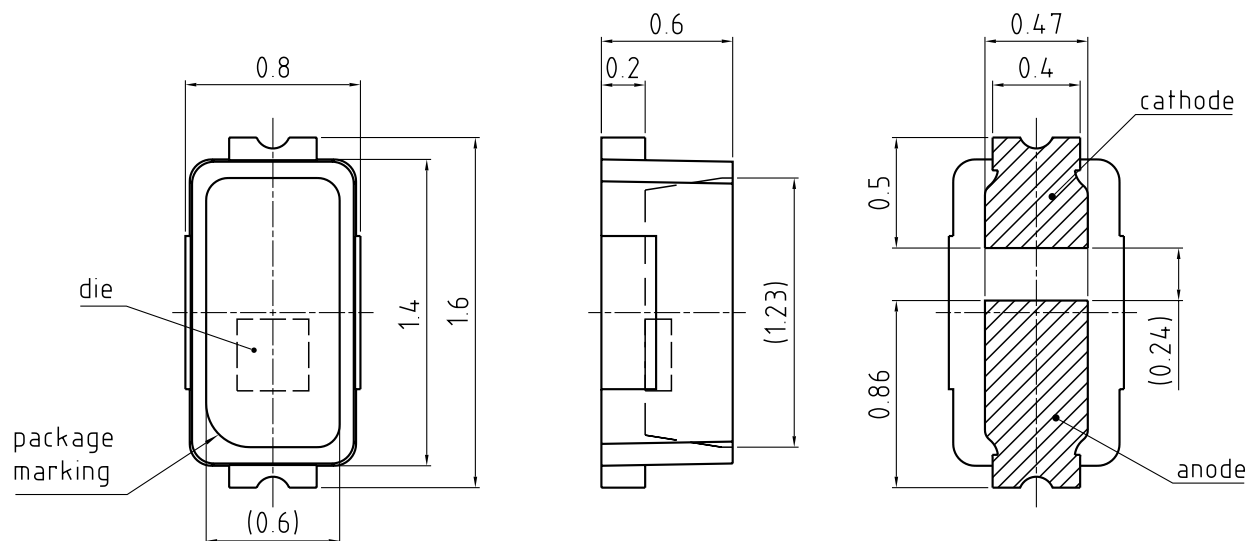

general tolerance  $\pm 0.1$   
lead finish Ag 

C67062-A0191-A2...-02

Further Information:

**Approximate Weight:** 2.0 mg

**Package marking:** Anode

**Corrosion test:** Class: 2B

Test condition: 25°C / 75 % RH / 10 ppm H<sub>2</sub>S / 21 days (IEC 60068-2-43)

Electrical Internal Circuit

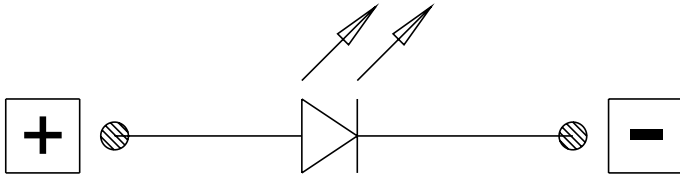

Recommended Solder Pad <sup>11)</sup>

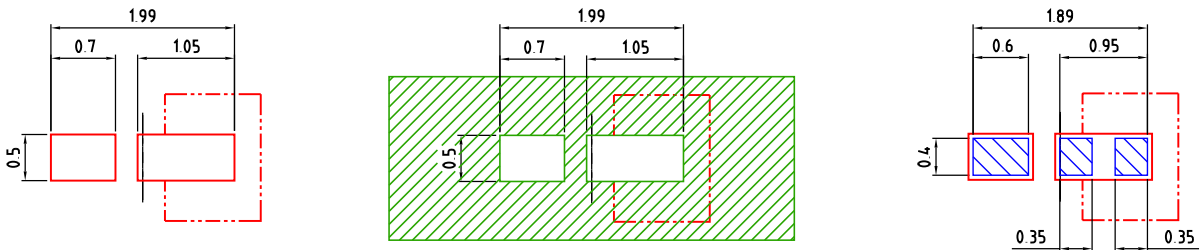

- foot print
- Cu area
- solder resist
- solder stencil

The usage of solder resist between anode and cathode pads is mandatory for applications where water may condense

Component Location on Pad

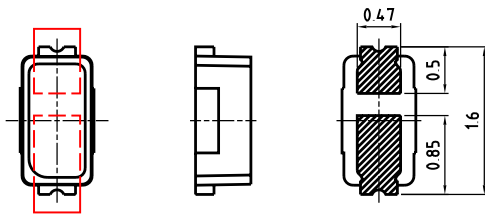

E062.3010.187 -02

All products are packed in a dry pack bag (Moisture Barrier Bag, MBB) according MIL-PRF-81705, after opening the MBB the products should go to reflow soldering process. Unused remaining LEDs should be protected from environment due to silver plated soldering terminal. In order to maintain solderability it is recommended to protect the silver plated solder terminals from corrosive environment before soldering. For superior solder joint connectivity results we recommend soldering under standard nitrogen atmosphere.

## Reflow Soldering Profile

Product complies to MSL Level 2 acc. to JEDEC J-STD-020E

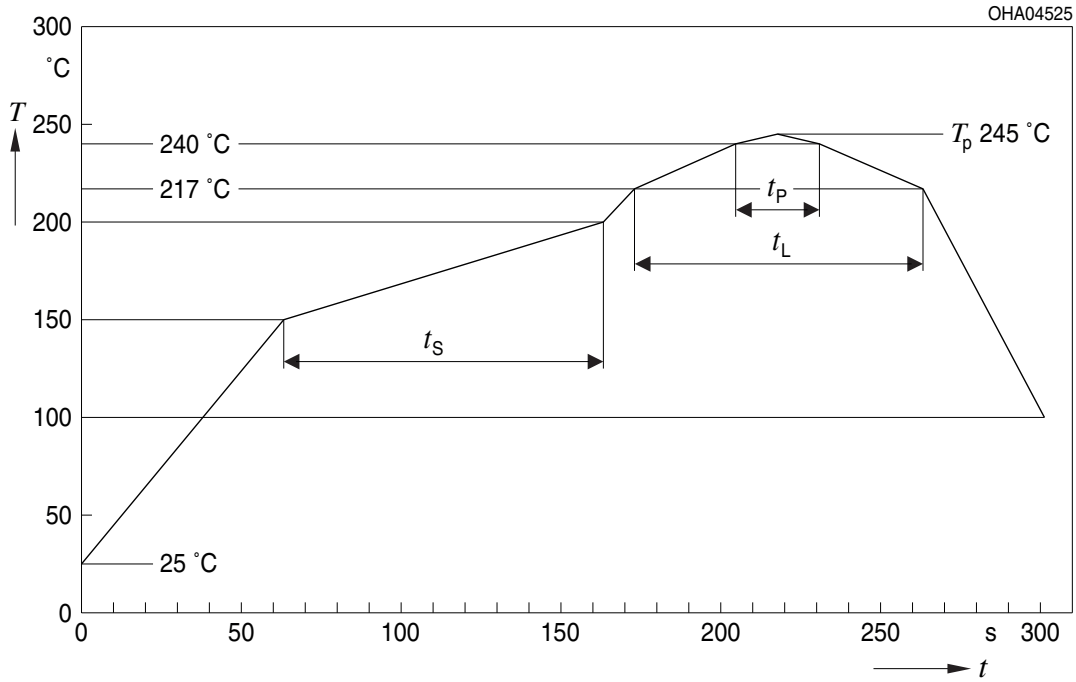

Profile Feature	Symbol	Pb-Free (SnAgCu) Assembly			Unit
		Minimum	Recommendation	Maximum	
Ramp-up rate to preheat <sup>*)</sup> 25 °C to 150 °C			2	3	K/s
Time $t_s$ $T_{Smin}$ to $T_{Smax}$	$t_s$	60	100	120	s
Ramp-up rate to peak <sup>*)</sup> $T_{Smax}$ to $T_p$			2	3	K/s
Liquidus temperature	$T_L$		217		°C
Time above liquidus temperature	$t_L$		80	100	s
Peak temperature	$T_p$		245	260	°C
Time within 5 °C of the specified peak temperature $T_p - 5$ K	$t_p$	10	20	30	s
Ramp-down rate* $T_p$ to 100 °C			3	6	K/s
Time 25 °C to $T_p$				480	s

All temperatures refer to the center of the package, measured on the top of the component  
<sup>\*</sup> slope calculation  $DT/Dt$ :  $Dt$  max. 5 s; fulfillment for the whole T-range

Taping <sup>11)</sup>

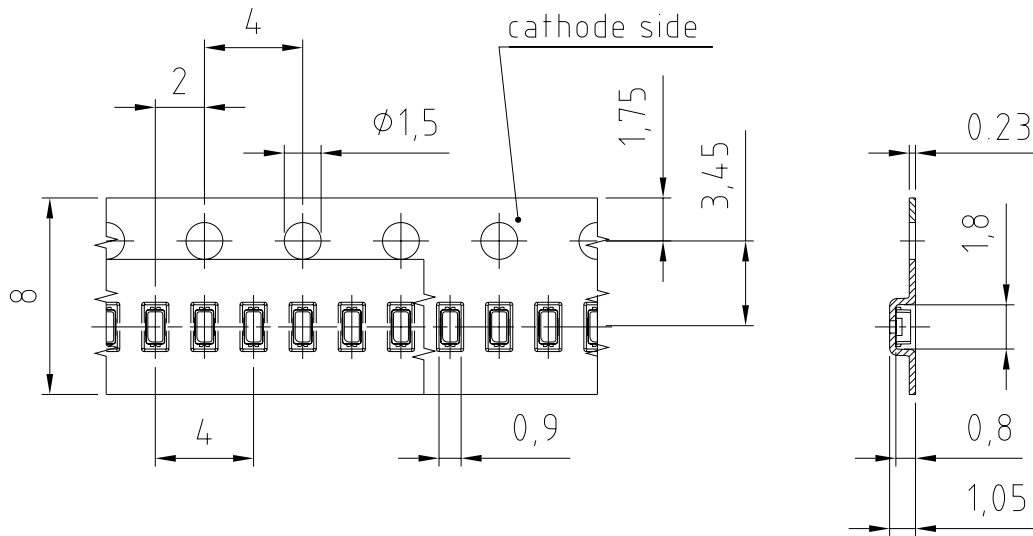

C63062-A4275-B5 -02

**Tape and Reel** <sup>12)</sup>

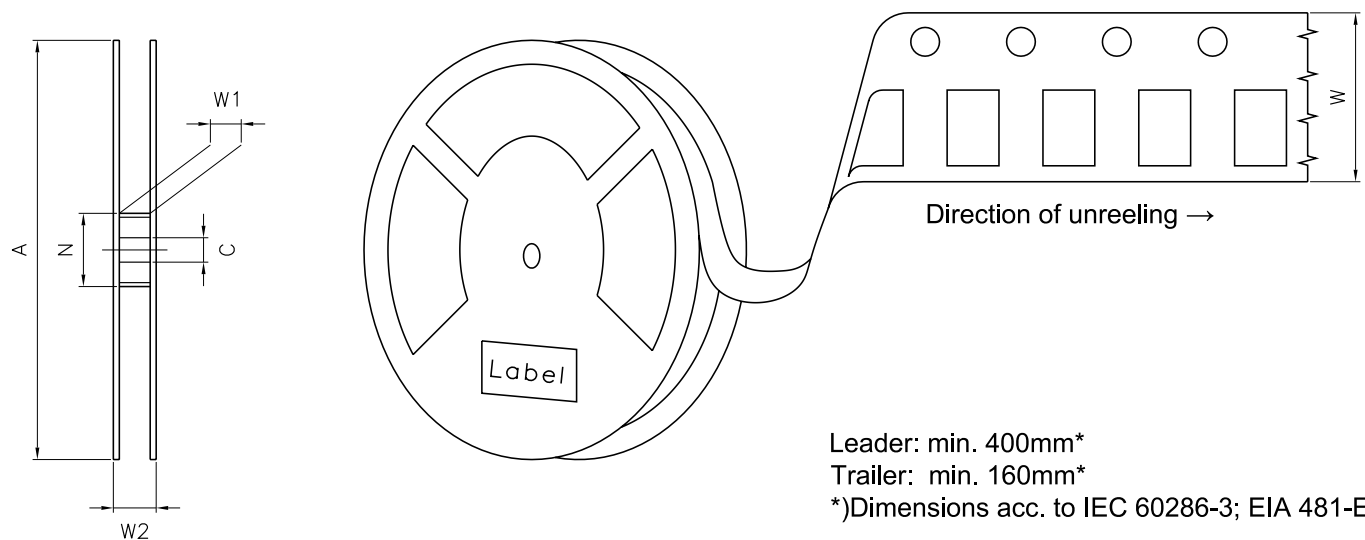

**Reel Dimensions**

A	W	N <sub>min</sub>	W <sub>1</sub>	W <sub>2 max</sub>	Pieces per PU
180 mm	8 + 0.3 / - 0.1 mm	60 mm	8.4 + 2 mm	14.4 mm	9000

### Barcode-Product-Label (BPL)

**OSRAM** LX XXXX    BIN1: XX-XX-X-XXX-X

RoHS Compliant

(6P) BATCH NO: 1234567890 ML Temp    ST  
X    XXX °C X

(1T) LOT NO: 1234567890 (9D) D/C: 1234

Pack: RXX  
DEMY    XXX  
X\_X123\_1234.1234 X

(X) PROD NO: 123456789(Q)QTY: 9999 (G) GROUP: XX-XX-X-X

OHA04563

### Dry Packing Process and Materials <sup>11)</sup>

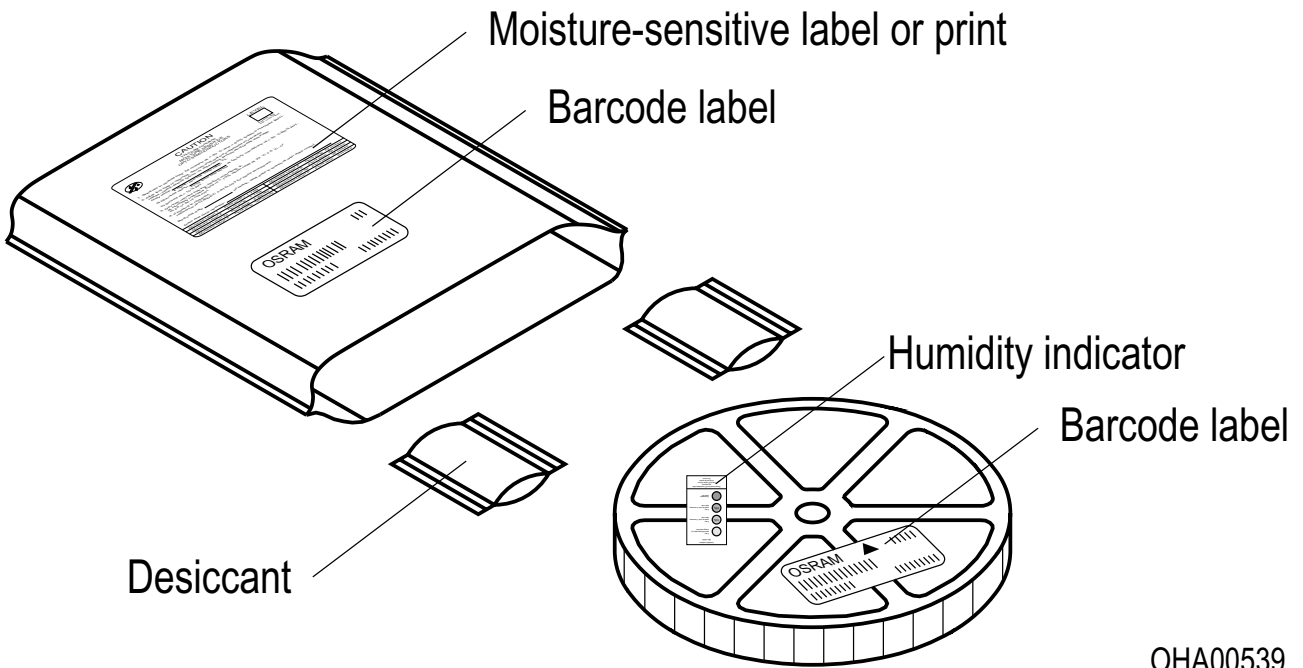

OHA00539

Moisture-sensitive product is packed in a dry bag containing desiccant and a humidity card according JEDEC-STD-033.

---

## Notes

The evaluation of eye safety occurs according to the standard IEC 62471:2006 (photo biological safety of lamps and lamp systems). Within the risk grouping system of this IEC standard, the device specified in this data sheet fall into the class **exempt group (exposure time 10000 s)**. Under real circumstances (for exposure time, conditions of the eye pupils, observation distance), it is assumed that no endangerment to the eye exists from these devices. As a matter of principle, however, it should be mentioned that intense light sources have a high secondary exposure potential due to their blinding effect. When looking at bright light sources (e.g. headlights), temporary reduction in visual acuity and afterimages can occur, leading to irritation, annoyance, visual impairment, and even accidents, depending on the situation.

Subcomponents of this device contain, in addition to other substances, metal filled materials including silver. Metal filled materials can be affected by environments that contain traces of aggressive substances. Therefore, we recommend that customers minimize device exposure to aggressive substances during storage, production, and use. Devices that showed visible discoloration when tested using the described tests above did show no performance deviations within failure limits during the stated test duration. Respective failure limits are described in the IEC60810.

For further application related information please visit <https://ams-osram.com/support/application-notes>

## Disclaimer

### Attention please!

The information describes the type of component and shall not be considered as assured characteristics. Terms of delivery and rights to change design reserved. Due to technical requirements components may contain dangerous substances.

For information on the types in question please contact our Sales Organization.

If printed or downloaded, please find the latest version on our website.

### Packing

Please use the recycling operators known to you. We can also help you – get in touch with your nearest sales office. By agreement we will take packing material back, if it is sorted. You must bear the costs of transport. For packing material that is returned to us unsorted or which we are not obliged to accept, we shall have to invoice you for any costs incurred.

### Product and functional safety devices/applications or medical devices/applications

Our components are not developed, constructed or tested for the application as safety relevant component or for the application in medical devices.

Our products are not qualified at module and system level for such application.

In case buyer – or customer supplied by buyer – considers using our components in product safety devices/ applications or medical devices/applications, buyer and/or customer has to inform our local sales partner immediately and we and buyer and /or customer will analyze and coordinate the customer-specific request between us and buyer and/or customer.

## Glossary

- 1) **Brightness:** Brightness values are measured during a current pulse of typically 25 ms, with an internal reproducibility of  $\pm 8\%$  and an expanded uncertainty of  $\pm 11\%$  (acc. to GUM with a coverage factor of  $k = 3$ ).
- 2) **Radiant intensity:** Measured at a solid angle of  $\Omega = 0.01$  sr
- 3) **Reverse Operation:** This product is intended to be operated applying a forward current within the specified range. Applying any continuous reverse bias or forward bias below the voltage range of light emission shall be avoided because it may cause migration which can change the electro-optical characteristics or damage the LED.
- 4) **Wavelength:** The wavelength is measured at a current pulse of typically 25 ms, with an internal reproducibility of  $\pm 0.5$  nm and an expanded uncertainty of  $\pm 1$  nm (acc. to GUM with a coverage factor of  $k = 3$ ).
- 5) **Wavelength:** The wavelengths are measured with a tolerance of  $\pm 1$  nm.
- 6) **Forward Voltage:** The forward voltage is measured during a current pulse of typically 8 ms, with an internal reproducibility of  $\pm 0.05$  V and an expanded uncertainty of  $\pm 0.1$  V (acc. to GUM with a coverage factor of  $k = 3$ ).
- 7) **Thermal Resistance:**  $R_{th\ max}$  is based on statistic values ( $6\sigma$ ) used for Derating.
- 8) **Brightness:** The brightness values are measured with a tolerance of  $\pm 11\%$ .
- 9) **Typical Values:** Due to the special conditions of the manufacturing processes of semiconductor devices, the typical data or calculated correlations of technical parameters can only reflect statistical figures. These do not necessarily correspond to the actual parameters of each single product, which could differ from the typical data and calculated correlations or the typical characteristic line. If requested, e.g. because of technical improvements, these typ. data will be changed without any further notice.
- 10) **Testing temperature:**  $T_A = 25^\circ\text{C}$  (unless otherwise specified)
- 11) **Tolerance of Measure:** Unless otherwise noted in drawing, tolerances are specified with  $\pm 0.1$  and dimensions are specified in mm.
- 12) **Tape and Reel:** All dimensions and tolerances are specified acc. IEC 60286-3 and specified in mm.

---

## Revision History

Version	Date	Change
1.0	2025-09-23	Maximum Ratings Derating (Diagrams)
1.1	2026-01-23	Characteristics Derating (Diagrams)

---



EU RoHS and China RoHS compliant product

此产品符合欧盟 RoHS 指令的要求；  
按照中国的相关法规和标准，  
不含有毒有害物质或元素。

**Published by ams-OSRAM AG**

Tobelbader Strasse 30, 8141 Premstaetten, Austria

Phone +43 3136 500-0

[ams-osram.com](http://ams-osram.com)

© All rights reserved

**am** 

**OSRAM**