

OSRAM KRTBRHLQ91.32

Datasheet

Published by **ams-OSRAM AG**

Tobelbader Strasse 30, 8141 Premstaetten, Austria

Phone +43 3136 500-0

ams-osram.com

© All rights reserved



DISPLIX® E2525

KRTB RHLQ91.32

This device is especially designed for intra-glass displays. The 4-lead (common anode) technology allows for an additive mixture of color stimuli by independent driving of each chip. As a result this device is the ideal component to create amazing media-enabled glass facades ranging from conference room walls to huge glass facades.

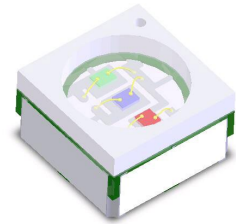

Applications

- Entertainment
- Projection & Display

Features

- Package: SMD epoxy package, colorless diffused resin
- Chip technology: InGaAlP on Sapphire / InGaN on Sapphire
- Typ. Radiation: 120° (Lambertian emitter)
- Color: $\lambda_{\text{dom}} = 621 \text{ nm}$ (● red); $\lambda_{\text{dom}} = 528 \text{ nm}$ (● true green); $\lambda_{\text{dom}} = 471 \text{ nm}$ (● blue)
- ESD: 500 V acc. to ANSI/ESDA/JEDEC JS-001 (HBM, Class 1B)

Ordering Information

Type	Brightness ¹⁾	Ordering Code
KRTBRHLQ91.32-SESI-GQ+UGVC-HU+QJRH-13		Q65112A9209
• red	• $I_v = 201 \dots 315 \text{ mcd}$ ($I_F = 6 \text{ mA}$)	
• true green	• $I_v = 560 \dots 900 \text{ mcd}$ ($I_F = 6 \text{ mA}$)	
• blue	• $I_v = 106 \dots 190 \text{ mcd}$ ($I_F = 6 \text{ mA}$)	

Maximum Ratings

Parameter	Symbol		Values	Values	Values
			● red	● true green	● blue
Operating Temperature	T_{op}	min.	-40 °C	-40 °C	-40 °C
		max.	85 °C	85 °C	85 °C
Storage Temperature	T_{stg}	min.	-40 °C	-40 °C	-40 °C
		max.	85 °C	85 °C	85 °C
Junction Temperature	T_j	max.	100 °C	100 °C	100 °C
Forward Current $T_s = 25\text{ °C}$	I_F	max.	20 mA	20 mA	20 mA
Forward Current pulsed $D = 0.125 ; T_s = 25\text{ °C}$	$I_{F\ pulse}$	max.	40 mA	40 mA	40 mA
Reverse voltage ²⁾ $T_s = 25\text{ °C}$	V_R	max.	10 V	10 V	10 V
ESD withstand voltage acc. to ANSI/ESDA/JEDEC JS-001 (HBM, Class 1B)	V_{ESD}		500 V	500 V	500 V

Characteristics

$I_F = 6 \text{ mA}$; $T_S = 25 \text{ °C}$

Parameter	Symbol		Values	Values	Values
			● red	● true green	● blue
Peak Wavelength	λ_{peak}	typ.	630 nm	520 nm	468 nm
Dominant Wavelength ³⁾	λ_{dom}	min.	618 nm	523 nm	466 nm
		typ.	621 nm	528 nm	471 nm
		max.	626 nm	534 nm	474 nm
Viewing angle at 50% I_V	2ϕ	typ.	120 °	120 °	120 °
Forward Voltage ⁴⁾ $I_F = 6 \text{ mA}$	V_F	min.	1.60 V	2.20 V	2.20 V
		typ.	1.90 V	2.50 V	2.60 V
		max.	2.30 V	2.90 V	2.90 V
Reverse current ²⁾ $V_R = 10 \text{ V}$	I_R	typ.	0.01 μA	0.01 μA	0.01 μA
		max.	1 μA	1 μA	1 μA
Real thermal resistance junction/solderpoint ⁵⁾	$R_{\text{thJS real}}$	typ.	450 K / W	400 K / W	320 K / W
		max.	540 K / W	480 K / W	390 K / W

Brightness Groups

- red

Group	Luminous Intensity ¹⁾	
	$I_F = 6 \text{ mA}$ min. I_v	$I_F = 6 \text{ mA}$ max. I_v
SE	201 mcd	250 mcd
SF	212 mcd	265 mcd
SG	224 mcd	280 mcd
SH	237 mcd	297 mcd
SI	250 mcd	315 mcd

Brightness Groups

- true green

Group	Luminous Intensity ¹⁾	
	$I_F = 6 \text{ mA}$ min. I_v	$I_F = 6 \text{ mA}$ max. I_v
UG	560 mcd	710 mcd
UH	594 mcd	754 mcd
UI	630 mcd	800 mcd
UJ	669 mcd	849 mcd
VC	710 mcd	900 mcd

Brightness Groups

- blue

Group	Luminous Intensity ¹⁾	
	$I_F = 6 \text{ mA}$ min. I_v	$I_F = 6 \text{ mA}$ max. I_v
QJ	106 mcd	132 mcd
RC	112 mcd	140 mcd
RD	118 mcd	149 mcd
RE	125 mcd	159 mcd
RF	132 mcd	169 mcd
RG	140 mcd	180 mcd
RH	149 mcd	190 mcd

Wavelength Groups

- red

Group	Dominant Wavelength ³⁾	Dominant Wavelength ³⁾
	min. λ_{dom}	max. λ_{dom}
GQ	618 nm	626 nm

Wavelength Groups

- true green

Group	Dominant Wavelength ³⁾	Dominant Wavelength ³⁾
	min. λ_{dom}	max. λ_{dom}
HN	523 nm	528 nm
LQ	526 nm	530 nm
NS	528 nm	532 nm
QU	530 nm	534 nm

Wavelength Groups

- blue

Group	Dominant Wavelength ³⁾	Dominant Wavelength ³⁾
	min. λ_{dom}	max. λ_{dom}
1	466 nm	470 nm
2	468 nm	472 nm
3	470 nm	474 nm

Relative Spectral Emission ⁶⁾

$I_{rel} = f(\lambda); I_F = 6 \text{ mA}; T_S = 25 \text{ }^\circ\text{C}$

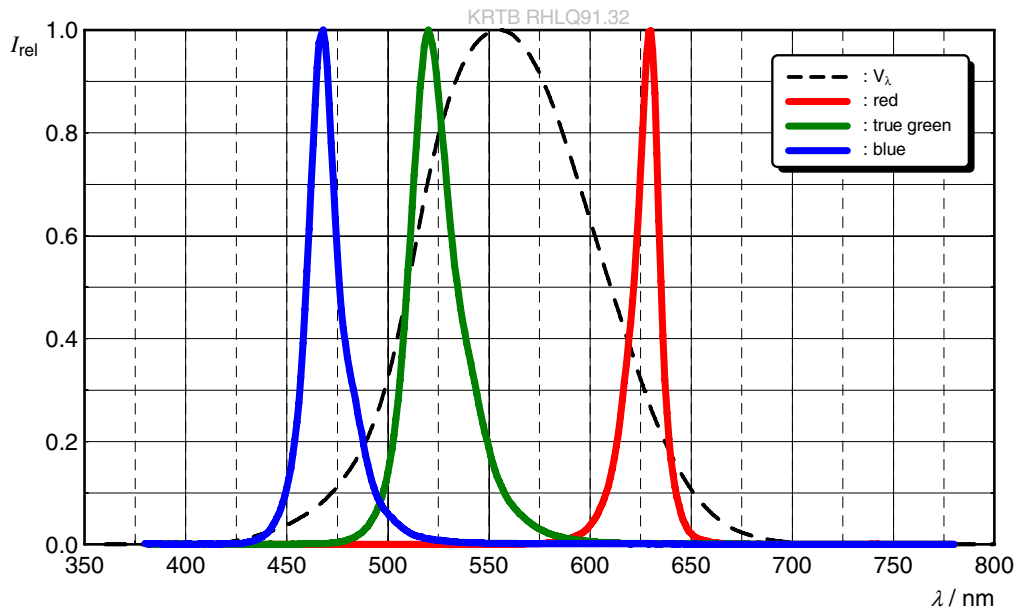

Radiation Characteristic (horizontal) ⁶⁾

$I_{rel} = f(\phi)$; $T_S = 25\text{ °C}$

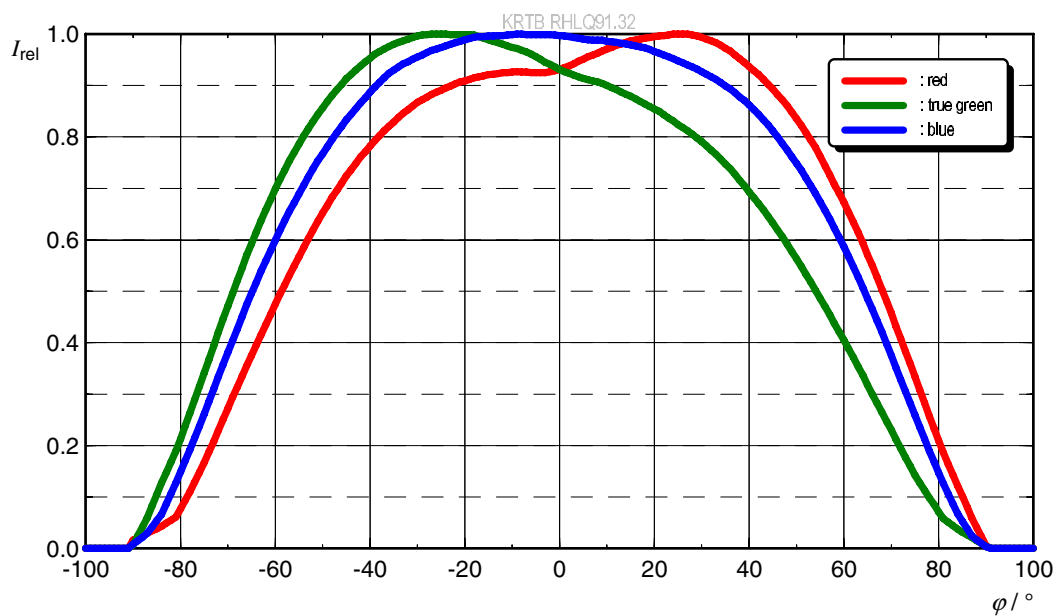

Radiation Characteristic (vertical) ⁶⁾

$I_{rel} = f(\phi)$; $T_S = 25\text{ °C}$

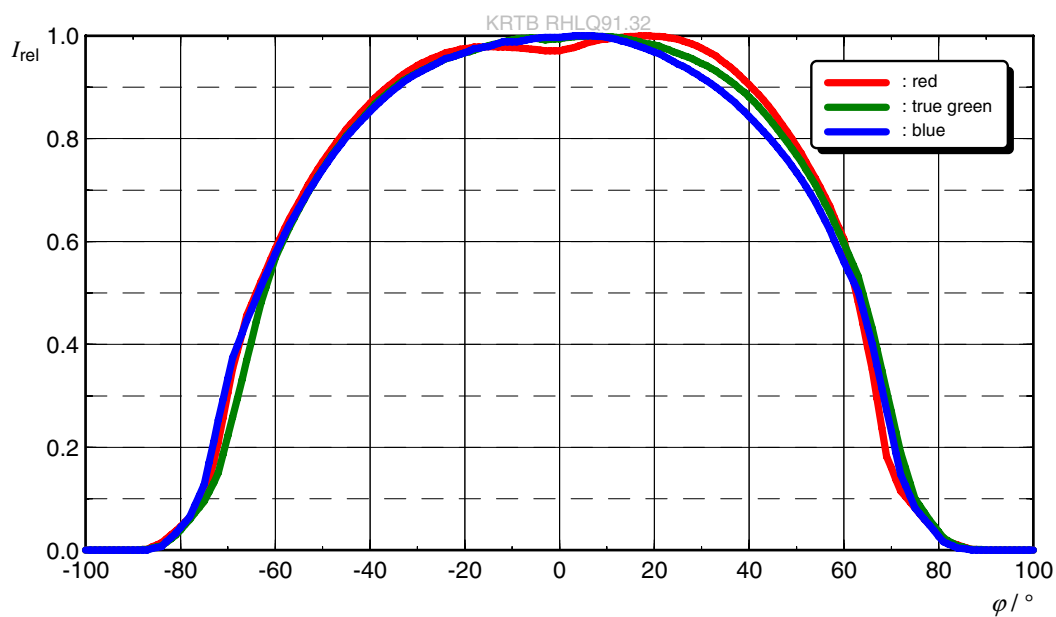

Forward current ⁶⁾

$$I_F = f(V_F); T_S = 25\text{ °C}$$

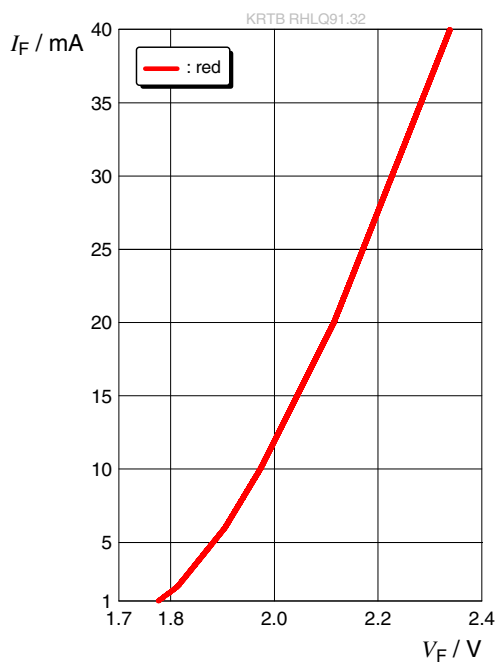

Forward current ⁶⁾

$$I_F = f(V_F); T_S = 25\text{ °C}$$

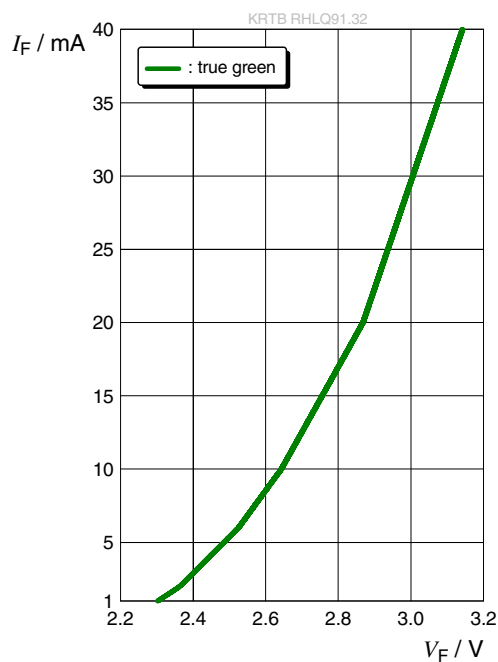

Forward current ⁶⁾

$$I_F = f(V_F); T_S = 25\text{ °C}$$

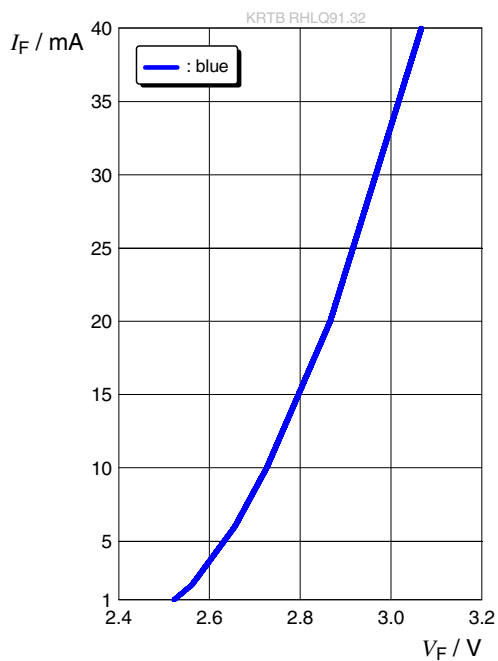

Relative Luminous Intensity ^{6), 7)}

$I_V/I_V(6\text{ mA}) = f(I_F); T_S = 25\text{ °C}$

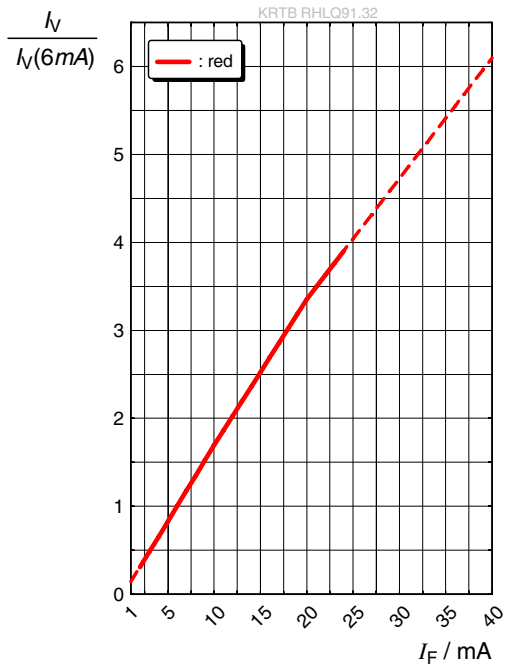

Relative Luminous Intensity ^{6), 7)}

$I_V/I_V(6\text{ mA}) = f(I_F); T_S = 25\text{ °C}$

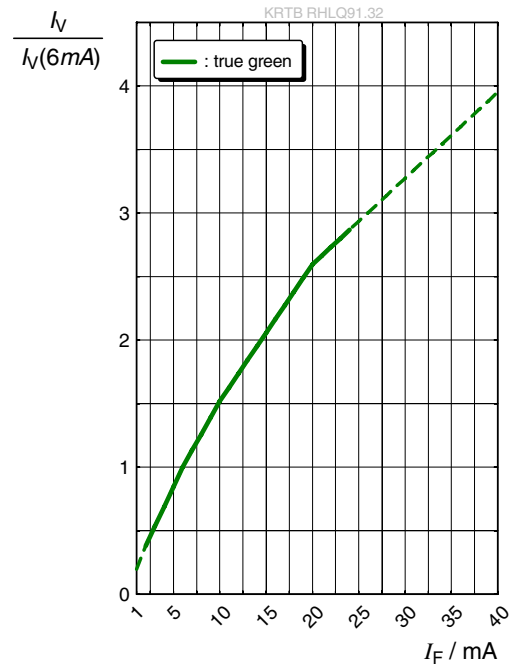

Relative Luminous Intensity ^{6), 7)}

$I_V/I_V(6\text{ mA}) = f(I_F); T_S = 25\text{ °C}$

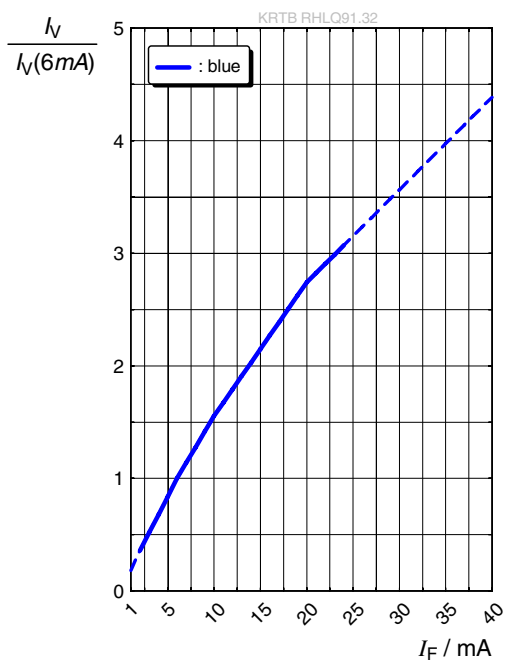

Dominant Wavelength ⁶⁾

$$\lambda_{\text{dom}} = f(I_F); T_S = 25\text{ °C}$$

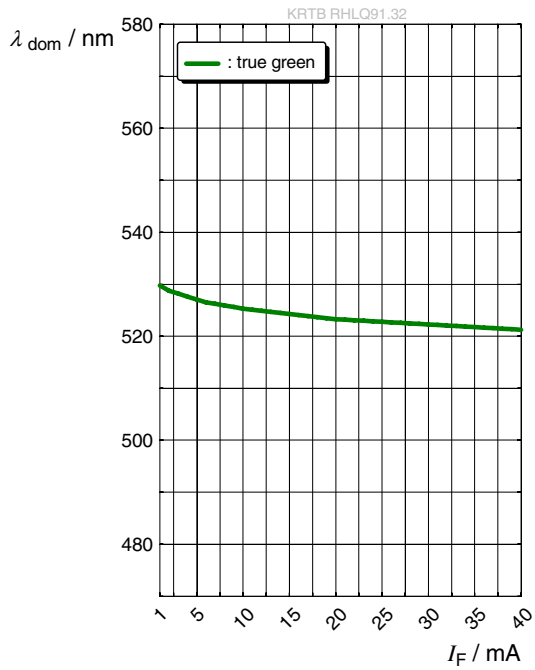

Dominant Wavelength ⁶⁾

$$\lambda_{\text{dom}} = f(I_F); T_S = 25\text{ °C}$$

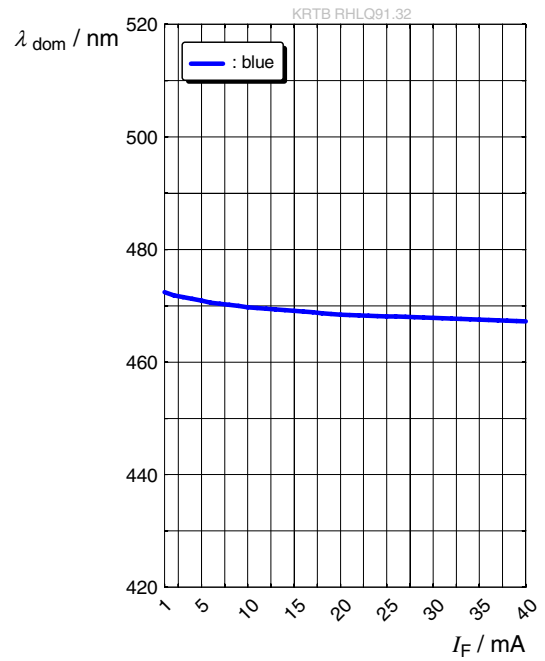

Forward Voltage ⁶⁾

$$\Delta V_F = V_F - V_F(25\text{ °C}) = f(T_j); I_F = 6\text{ mA}$$

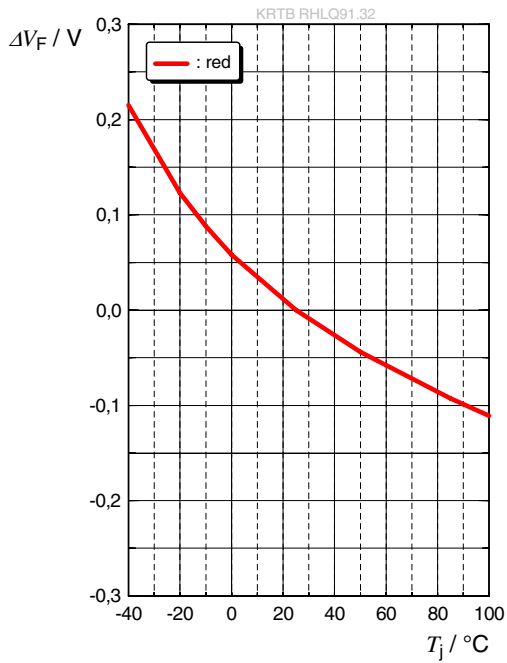

Forward Voltage ⁶⁾

$$\Delta V_F = V_F - V_F(25\text{ °C}) = f(T_j); I_F = 6\text{ mA}$$

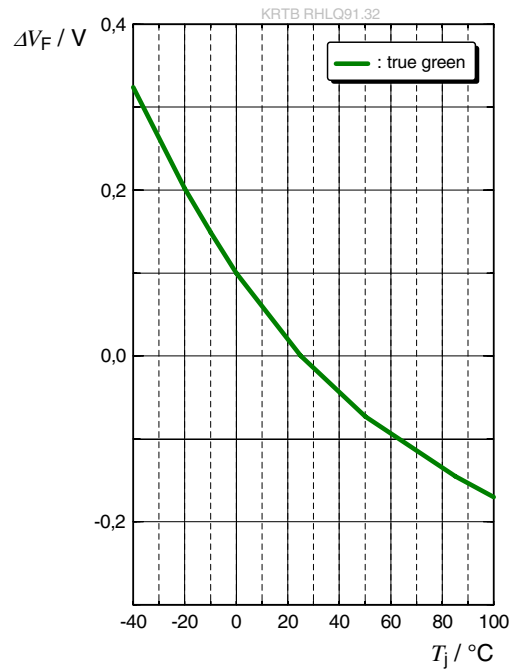

Forward Voltage ⁶⁾

$$\Delta V_F = V_F - V_F(25\text{ °C}) = f(T_j); I_F = 6\text{ mA}$$

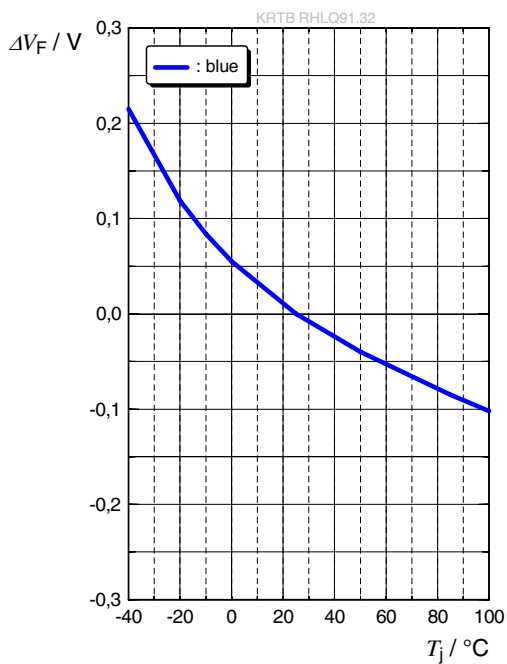

Relative Luminous Intensity ⁶⁾

$$I_V/I_V(25\text{ °C}) = f(T_j); I_F = 6\text{ mA}$$

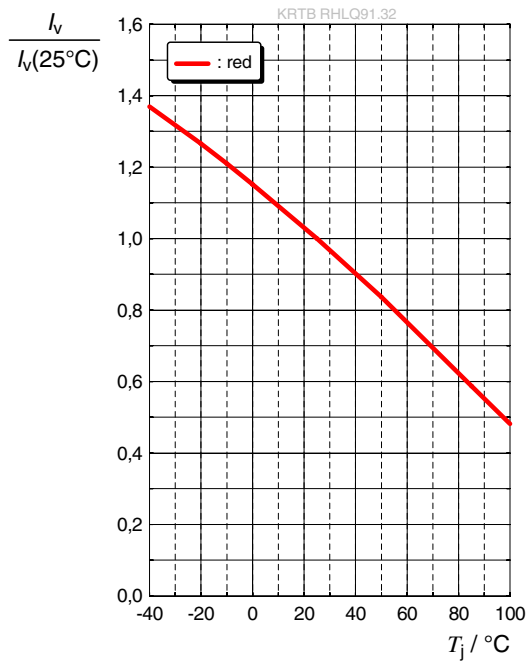

Relative Luminous Intensity ⁶⁾

$$I_V/I_V(25\text{ °C}) = f(T_j); I_F = 6\text{ mA}$$

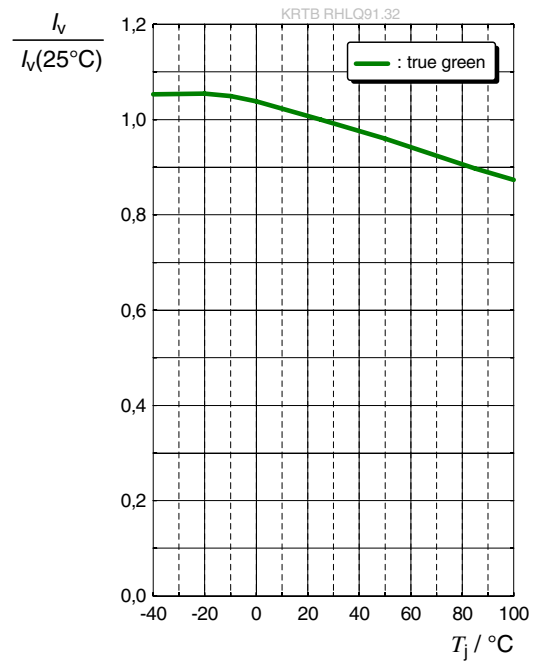

Relative Luminous Intensity ⁶⁾

$$I_V/I_V(25\text{ °C}) = f(T_j); I_F = 6\text{ mA}$$

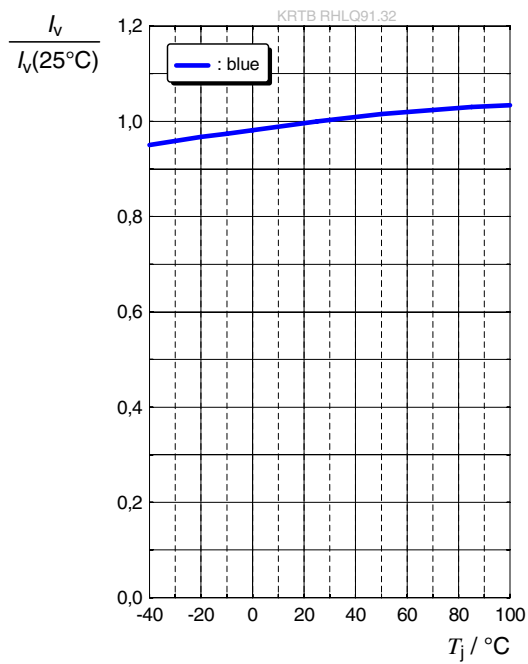

Dominant Wavelength ⁶⁾

$$\Delta\lambda_{\text{dom}} = \lambda_{\text{dom}} - \lambda_{\text{dom}}(25\text{ °C}) = f(T_j); I_F = 6\text{ mA}$$

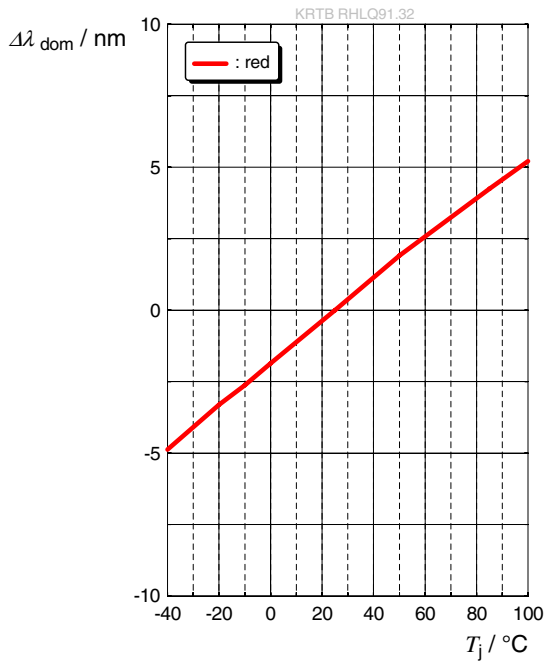

Dominant Wavelength ⁶⁾

$$\Delta\lambda_{\text{dom}} = \lambda_{\text{dom}} - \lambda_{\text{dom}}(25\text{ °C}) = f(T_j); I_F = 6\text{ mA}$$

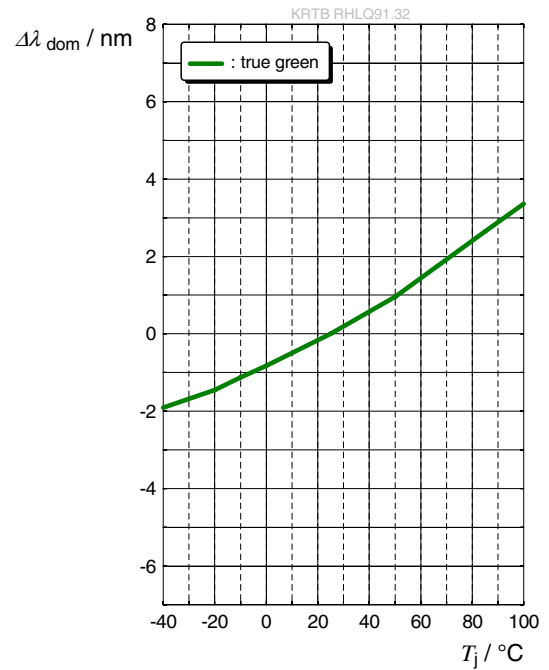

Dominant Wavelength ⁶⁾

$$\Delta\lambda_{\text{dom}} = \lambda_{\text{dom}} - \lambda_{\text{dom}}(25\text{ °C}) = f(T_j); I_F = 6\text{ mA}$$

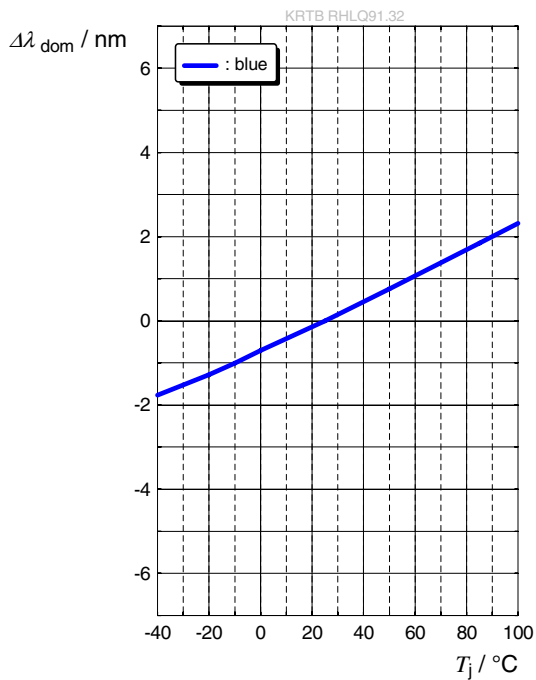

Max. Permissible Forward Current ⁵⁾

$I_F = f(T)$; ● red

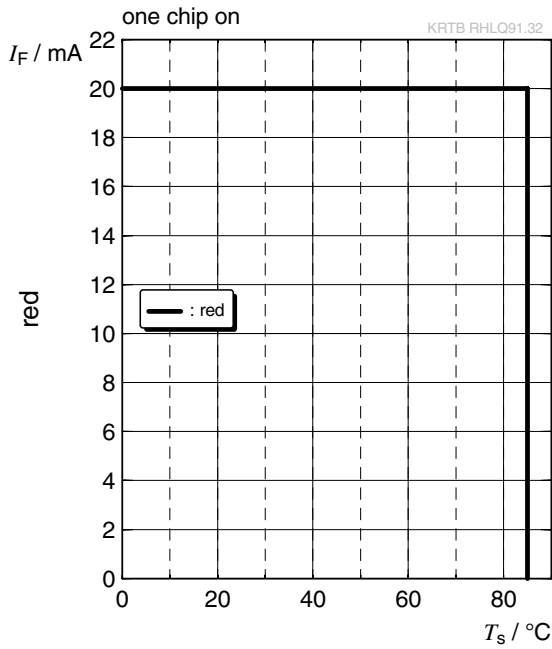

Max. Permissible Forward Current ⁵⁾

$I_F = f(T)$; ● true green

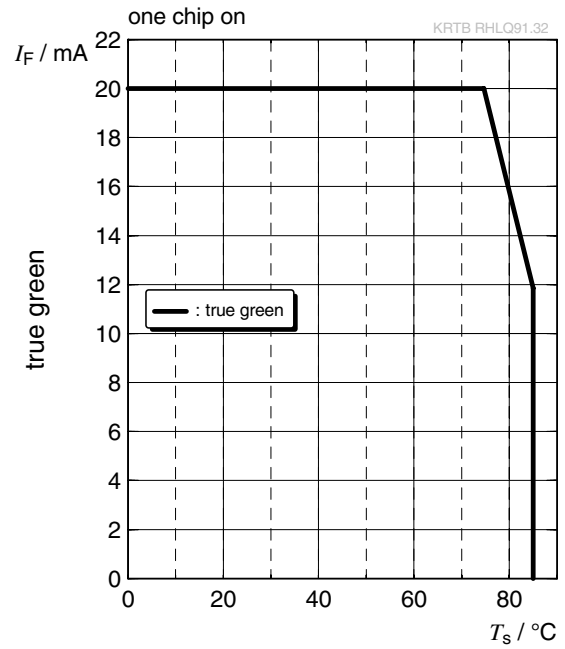

Max. Permissible Forward Current ⁵⁾

$I_F = f(T)$; ● blue

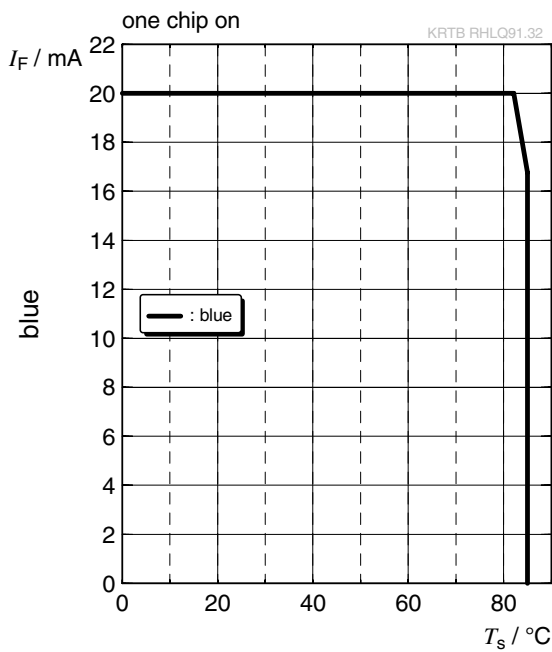

Permissible Pulse Handling Capability

$I_F = f(t_p)$; D: Duty cycle; ● red

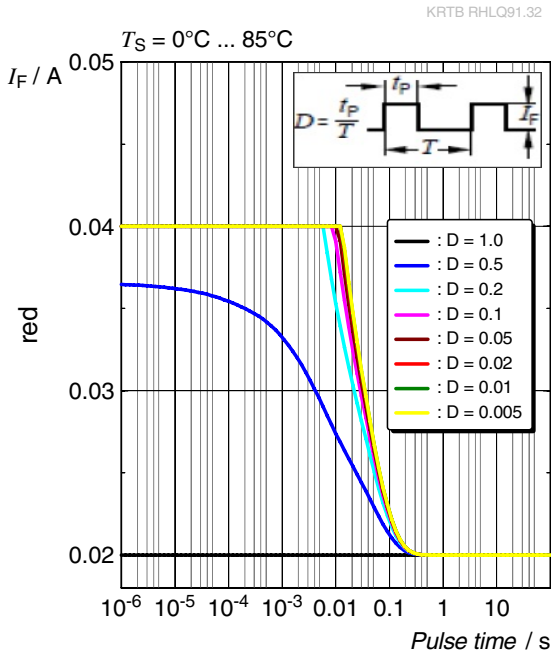

Permissible Pulse Handling Capability

$I_F = f(t_p)$; D: Duty cycle; ● true green

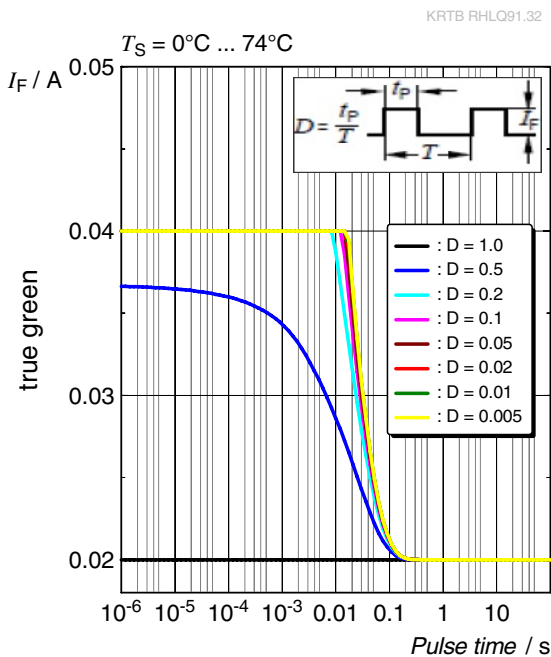

Permissible Pulse Handling Capability

$I_F = f(t_p)$; D: Duty cycle; ● true green

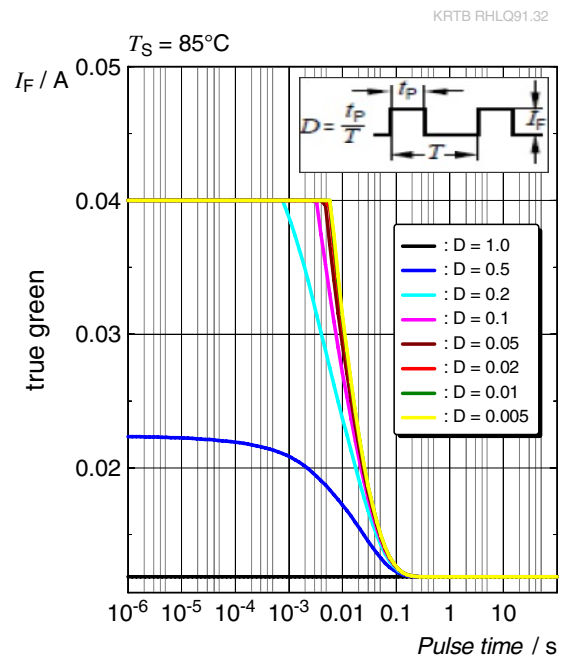

Permissible Pulse Handling Capability

$I_F = f(t_p)$; D: Duty cycle; • blue

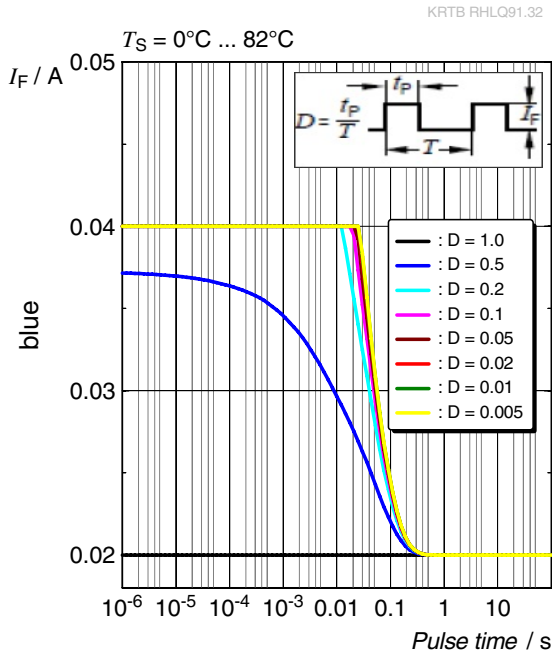

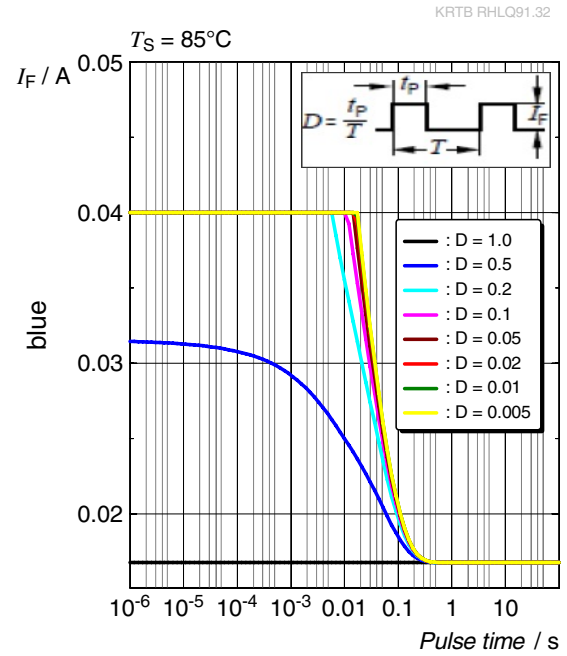

Permissible Pulse Handling Capability

$I_F = f(t_p)$; D: Duty cycle; • blue

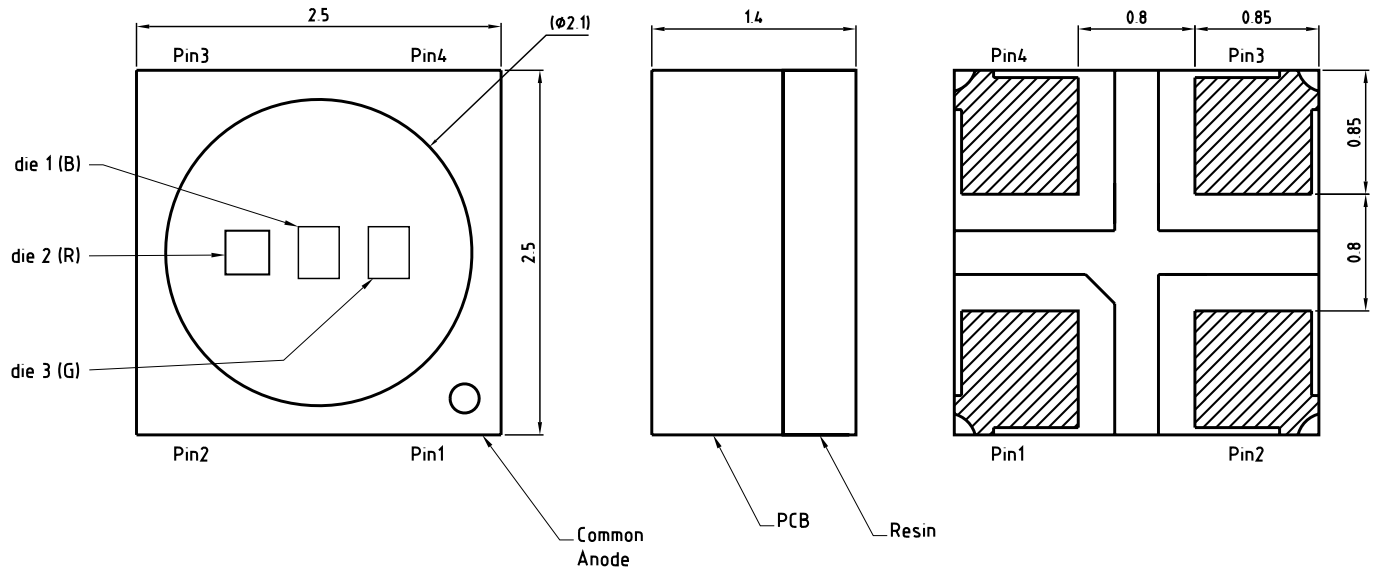

Dimensional Drawing ⁸⁾



general tolerance ± 0.1
lead finish Ag 

C63062-A4386-A1-03

Further Information:

Approximate Weight: 17.0 mg

Package marking: Anode

Notes: Package not suitable for any kind of wet cleaning or ultrasonic cleaning.

Electrical Internal Circuit

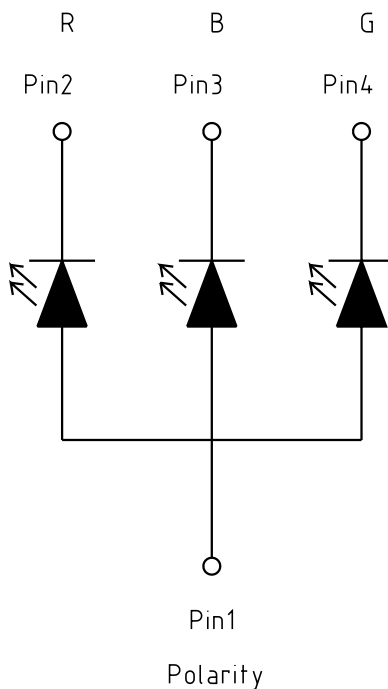

Recommended Solder Pad ⁸⁾

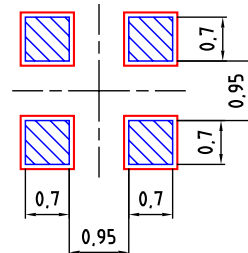
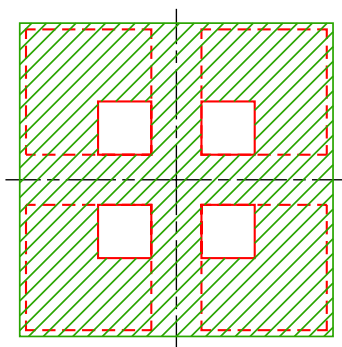
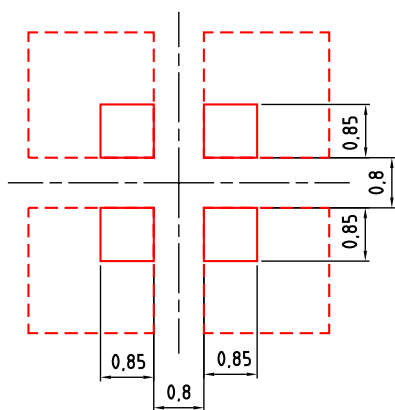

foot print



Cu area



solder resist



solder stencil

E062.3010.268-01

For superior solder joint connectivity results we recommend soldering under standard nitrogen atmosphere. Package not suitable for any kind of wet cleaning or ultrasonic cleaning.

Reflow Soldering Profile

Product complies to MSL Level 4 acc. to JEDEC J-STD-020E

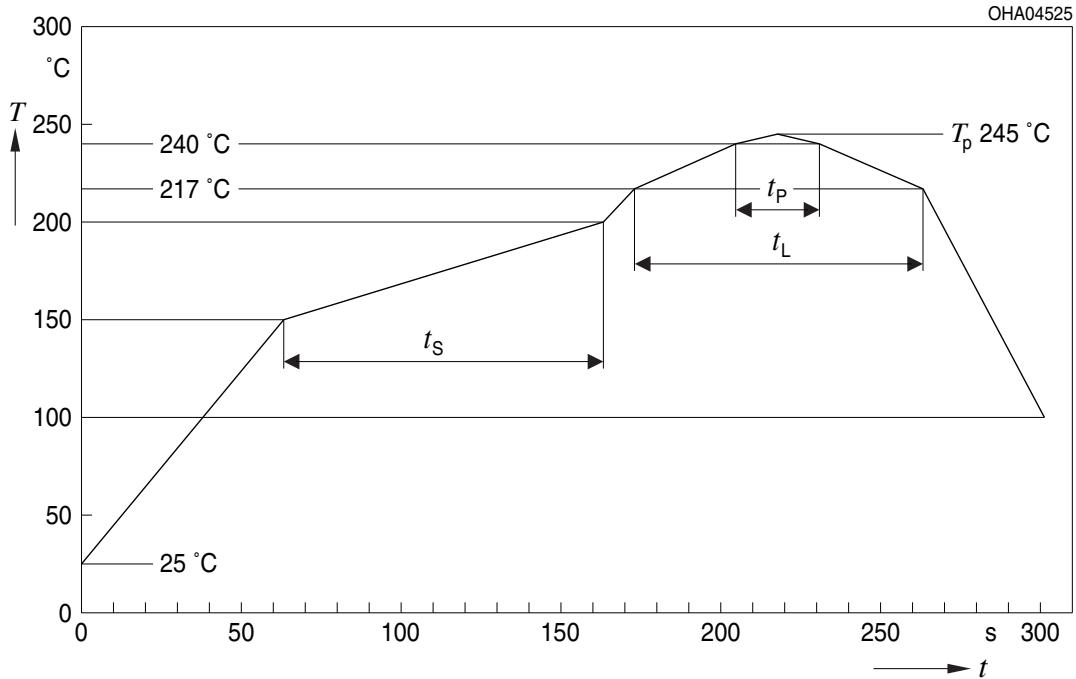

Profile Feature	Symbol	Pb-Free (SnAgCu) Assembly			Unit
		Minimum	Recommendation	Maximum	
Ramp-up rate to preheat ^{*)} 25 °C to 150 °C			2	3	K/s
Time t_s T_{Smin} to T_{Smax}	t_s	60	100	120	s
Ramp-up rate to peak ^{*)} T_{Smax} to T_p			2	3	K/s
Liquidus temperature	T_L		217		°C
Time above liquidus temperature	t_L		80	100	s
Peak temperature	T_p		245	260	°C
Time within 5 °C of the specified peak temperature $T_p - 5$ K	t_p	10	20	30	s
Ramp-down rate* T_p to 100 °C			3	6	K/s
Time 25 °C to T_p				480	s

All temperatures refer to the center of the package, measured on the top of the component
^{*)} slope calculation DT/Dt : Dt max. 5 s; fulfillment for the whole T-range

Tape and Reel ⁹⁾

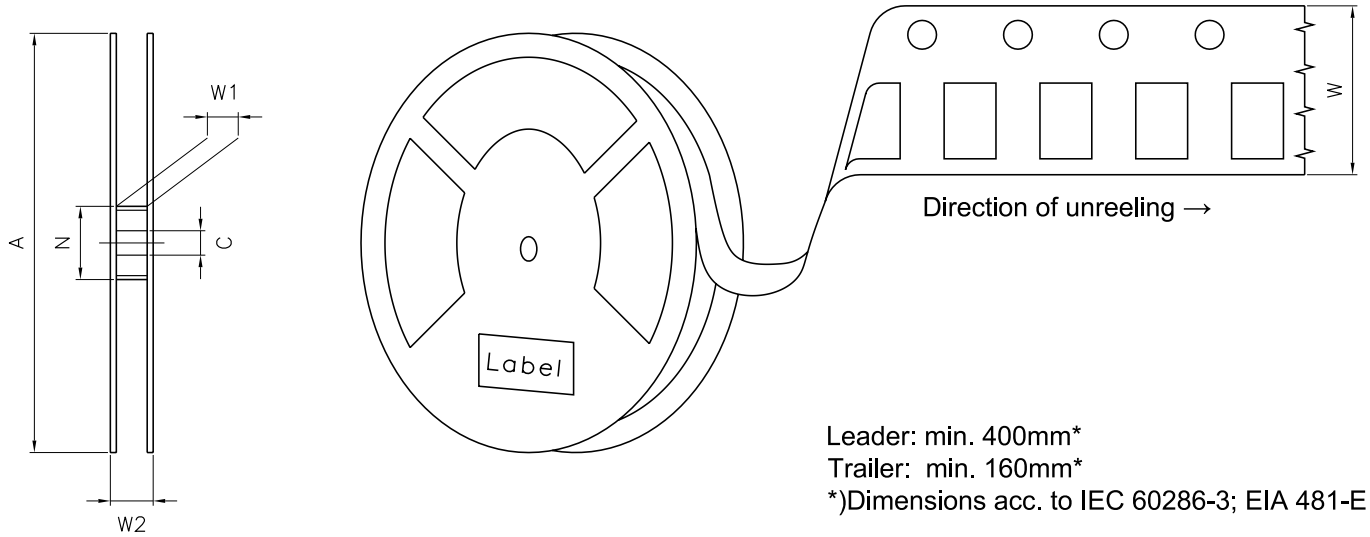

Reel Dimensions

A	W	N _{min}	W ₁	W _{2 max}	Pieces per PU
180 mm	8 + 0.3 / - 0.1 mm	60 mm	8.4 + 2 mm	14.4 mm	2000

Barcode-Product-Label (BPL)

OSRAM LX XXXX BIN1: XX-XX-X-XXX-X

RoHS Compliant

(6P) BATCH NO: 1234567890

(1T) LOT NO: 1234567890 (9D) D/C: 1234

(X) PROD NO: 123456789 (Q) QTY: 9999 (G) GROUP: XX-XX-X-X

ML Temp ST
X XXX °C X

Pack: RXX
DEMY XXX
X_X123_1234.1234 X

OHA04563

Dry Packing Process and Materials ⁸⁾

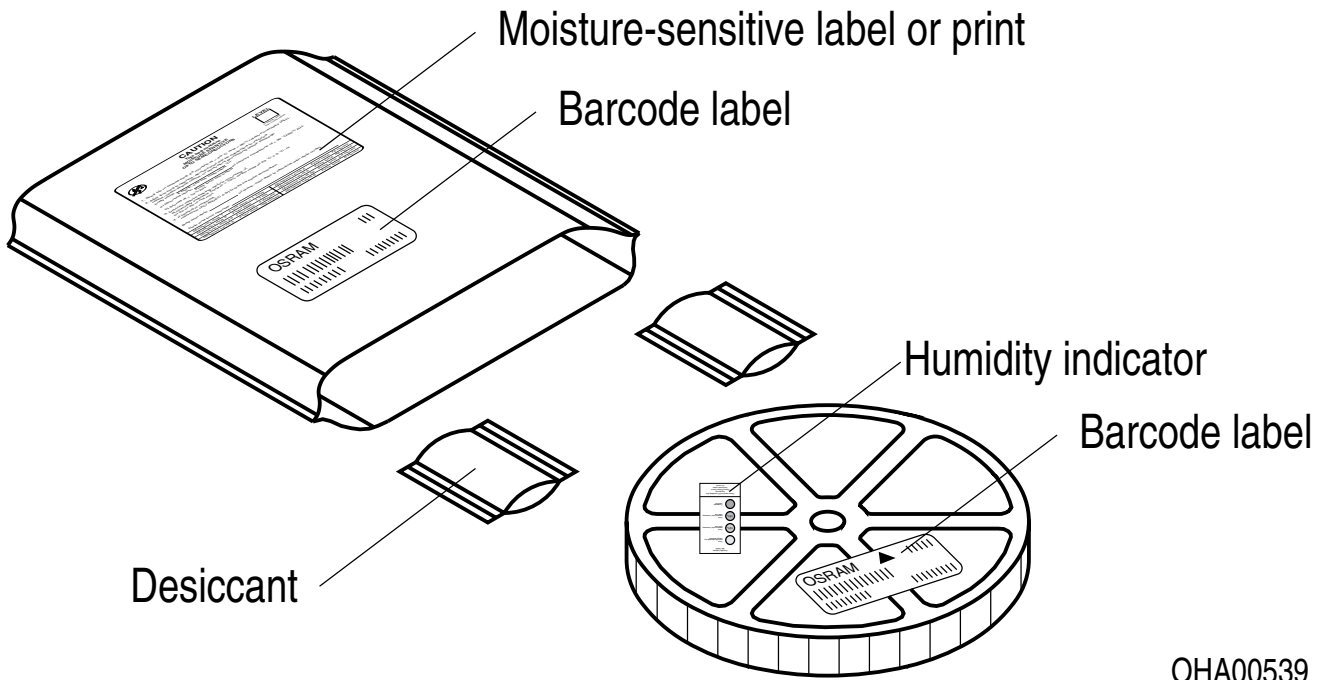

Moisture-sensitive product is packed in a dry bag containing desiccant and a humidity card according JEDEC-STD-033.

Notes

The evaluation of eye safety occurs according to the standard IEC 62471:2006 (photo biological safety of lamps and lamp systems). Within the risk grouping system of this IEC standard, the device specified in this data sheet fall into the class **exempt group (exposure time 10000 s)**. Under real circumstances (for exposure time, conditions of the eye pupils, observation distance), it is assumed that no endangerment to the eye exists from these devices. As a matter of principle, however, it should be mentioned that intense light sources have a high secondary exposure potential due to their blinding effect. When looking at bright light sources (e.g. headlights), temporary reduction in visual acuity and afterimages can occur, leading to irritation, annoyance, visual impairment, and even accidents, depending on the situation.

Subcomponents of this device contain, in addition to other substances, metal filled materials including silver. Metal filled materials can be affected by environments that contain traces of aggressive substances. Therefore, we recommend that customers minimize device exposure to aggressive substances during storage, production, and use. Devices that showed visible discoloration when tested using the described tests above did show no performance deviations within failure limits during the stated test duration. Respective failure limits are described in the IEC60810.

Changes to the content of this datasheet may occur without further notification. JEDEC 46C constitutes the guideline of the change management for the device specified in this document.

For further application related information please visit <https://ams-osram.com/support/application-notes>

Disclaimer

Attention please!

The information describes the type of component and shall not be considered as assured characteristics. Terms of delivery and rights to change design reserved. Due to technical requirements components may contain dangerous substances.

For information on the types in question please contact our Sales Organization.

If printed or downloaded, please find the latest version on our website.

Packing

Please use the recycling operators known to you. We can also help you – get in touch with your nearest sales office. By agreement we will take packing material back, if it is sorted. You must bear the costs of transport. For packing material that is returned to us unsorted or which we are not obliged to accept, we shall have to invoice you for any costs incurred.

Product and functional safety devices/applications or medical devices/applications

Our components are not developed, constructed or tested for the application as safety relevant component or for the application in medical devices.

Our products are not qualified at module and system level for such application.

In case buyer – or customer supplied by buyer – considers using our components in product safety devices/ applications or medical devices/applications, buyer and/or customer has to inform our local sales partner immediately and we and buyer and /or customer will analyze and coordinate the customer-specific request between us and buyer and/or customer.

Glossary

- 1) **Brightness:** Brightness groups are tested at a current pulse duration of 25 ms and a tolerance of $\pm 11\%$.
- 2) **Reverse Operation:** This product is intended to be operated applying a forward current within the specified range. Applying any continuous reverse bias or forward bias below the voltage range of light emission shall be avoided because it may cause migration which can change the electro-optical characteristics or damage the LED.
- 3) **Wavelength:** Wavelengths are tested at a current pulse duration of 25 ms and a tolerance of ± 1 nm.
- 4) **Forward Voltage:** Forward voltages are tested at a current pulse duration of 1 ms and a tolerance of ± 0.1 V.
- 5) **Thermal Resistance:** $R_{th\ max}$ is based on statistic values (6σ) used for Derating.
- 6) **Typical Values:** Due to the special conditions of the manufacturing processes of semiconductor devices, the typical data or calculated correlations of technical parameters can only reflect statistical figures. These do not necessarily correspond to the actual parameters of each single product, which could differ from the typical data and calculated correlations or the typical characteristic line. If requested, e.g. because of technical improvements, these typ. data will be changed without any further notice.
- 7) **Characteristic curve:** In the range where the line of the graph is broken, you must expect higher differences between single devices within one packing unit.
- 8) **Tolerance of Measure:** Unless otherwise noted in drawing, tolerances are specified with ± 0.1 and dimensions are specified in mm.
- 9) **Tape and Reel:** All dimensions and tolerances are specified acc. IEC 60286-3 and specified in mm.

Revision History

Version	Date	Change
1.0	2020-03-18	Initial Version
1.1	2023-11-08	New Layout Applications



EU RoHS and China RoHS compliant product

此产品符合欧盟 RoHS 指令的要求；
按照中国的相关法规和标准，
不含有毒有害物质或元素。

Published by ams-OSRAM AG

Tobelbader Strasse 30, 8141 Premstaetten, Austria

Phone +43 3136 500-0

ams-osram.com

© All rights reserved

am 

OSRAM