

OSRAM KW3 CGLNM3.TK

Datasheet

Published by **ams-OSRAM AG**

Tobelbader Strasse 30, 8141 Premstaetten, Austria

Phone +43 3136 500-0

ams-osram.com

© All rights reserved



OSLON® Compact PL

KW3 CGLNM3.TK

Compact light source with isolated thermal pad for improved heat dissipation and small z-tolerance (+/- 35 µm).
The OSLON Compact PL product family meets both excellent brightness in combination with outstanding luminance.



Applications

- Dynamic Forward Lighting
- Static Forward Lighting

Features

- Package: Ceramic package
- Chip technology: UX:3
- Typ. Radiation: 120° (Lambertian emitter)
- Color: Cx = 0.316, Cy = 0.330 acc. to CIE 1931 (• white)
- Corrosion Robustness Class: 3A
- Qualifications: AEC-Q102 Qualified
- ESD: 8 kV acc. to ANSI/ESDA/JEDEC JS-001 (HBM, Class 3B)
- Color over angle: Better than passus 3.7.2.1 of supplement proposal 7 to ECE reg. 128

Ordering Information

| Type | Luminous Flux ¹⁾ $I_F = 1000 \text{ mA}$ Φ_V | Ordering Code |
|--------------------------------|--|---------------|
| KW3 CGLNM3.TK-T4T9-4L07M0-JCAB | 1140 ... 1425 lm | Q65113A4039 |

Maximum Ratings

| Parameter | Symbol | | Values |
|---|----------------|------|---------|
| Operating Temperature ²⁾ | T_{op} | min. | -40 °C |
| | | max. | 135 °C |
| Storage Temperature | T_{stg} | min. | -40 °C |
| | | max. | 135 °C |
| Junction Temperature | T_j | max. | 150 °C |
| Junction Temperature for short time applications* | T_j | max. | 175 °C |
| Forward current $T_s = 25\text{ °C}$ | I_F | min. | 50 mA |
| | | max. | 1500 mA |
| Forward current pulsed $D = 0.005 ; T_s = 25\text{ °C}$ | $I_{F\ pulse}$ | max. | 1500 mA |
| Surge current $t \leq 50\ \mu\text{s}; D = 0.025; T_j = 150\text{ °C}$ | I_{FS} | max. | 2000 mA |
| Surge current $t \leq 10\ \mu\text{s}; D = 0.005 ; T_s = 25\text{ °C}$ | I_{FS} | max. | 2500 mA |
| ESD withstand voltage acc. to ANSI/ESDA/JEDEC JS-001 (HBM, Class 3B) | V_{ESD} | | 8 kV |
| Reverse current ³⁾ | I_R | max. | 200 mA |

* The median lifetime (L70/B50) for $T_j = 175\text{ °C}$ is 100h.

Characteristics

$I_F = 1000 \text{ mA}$; $T_S = 25 \text{ }^\circ\text{C}$

| Parameter | Symbol | | Values |
|--|-------------------------|------|-----------|
| Chromaticity Coordinate ⁴⁾ | Cx | typ. | 0.316 |
| | Cy | typ. | 0.330 |
| Viewing angle at 50% I_V | 2ϕ | typ. | 120 ° |
| Forward Voltage ⁵⁾ $I_F = 1000 \text{ mA}$ | V_F | min. | 8.40 V |
| | | typ. | 9.47 V |
| | | max. | 10.15 V |
| Reverse voltage (ESD device) | $V_{R\text{ESD}}$ | min. | 45 V |
| Reverse voltage ³⁾ $I_R = 20 \text{ mA}$ | V_R | max. | 1.2 V |
| | | | |
| Real thermal resistance junction/solderpoint ⁶⁾ | $R_{\text{thJS real}}$ | typ. | 2.5 K / W |
| | | max. | 3.0 K / W |
| Electrical thermal resistance junction/solderpoint ⁶⁾ with efficiency $\eta_e = 39 \%$ | $R_{\text{thJS elec.}}$ | typ. | 1.5 K / W |
| | | max. | 1.8 K / W |

Brightness Groups

| Group | Luminous Flux ¹⁾ $I_F = 1000 \text{ mA}$ min. Φ_V | Luminous Flux ¹⁾ $I_F = 1000 \text{ mA}$ max. Φ_V |
|-------|--|--|
| T4 | 1140 lm | 1185 lm |
| T5 | 1185 lm | 1230 lm |
| T6 | 1230 lm | 1275 lm |
| T7 | 1275 lm | 1325 lm |
| T8 | 1325 lm | 1375 lm |
| T9 | 1375 lm | 1425 lm |

Forward Voltage Groups

| Group | Forward Voltage ⁵⁾ $I_F = 1000 \text{ mA}$ min. V_F | Forward Voltage ⁵⁾ $I_F = 1000 \text{ mA}$ max. V_F |
|-------|---|---|
| JC | 8.40 V | 9.00 V |
| WC | 9.00 V | 9.60 V |
| AB | 9.60 V | 10.15 V |

Chromaticity Coordinate Groups

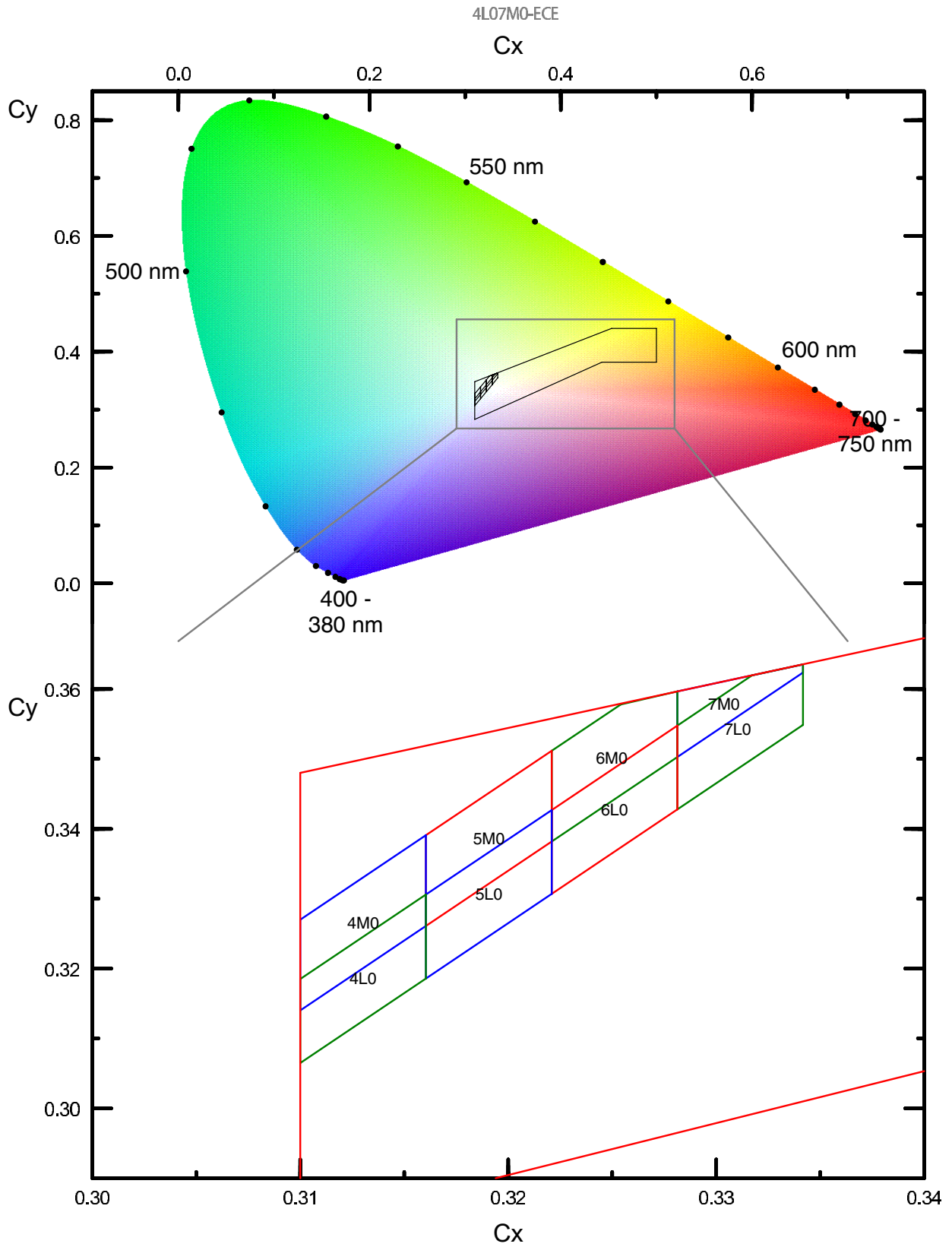

Chromaticity Coordinate Groups ⁴⁾

| Group | Cx | Cy | Group | Cx | Cy | Group | Cx | Cy |
|-------|--------|--------|-------|--------|--------|-------|--------|--------|
| 4L0 | 0.3100 | 0.3065 | 5M0 | 0.3160 | 0.3261 | 7L0 | 0.3281 | 0.3428 |
| | 0.3100 | 0.3185 | | 0.3160 | 0.3391 | | 0.3281 | 0.3548 |
| | 0.3160 | 0.3306 | | 0.3221 | 0.3512 | | 0.3317 | 0.3620 |
| | 0.3160 | 0.3186 | | 0.3221 | 0.3382 | | 0.3342 | 0.3635 |
| 4M0 | 0.3100 | 0.3140 | 6L0 | 0.3221 | 0.3307 | 7M0 | 0.3281 | 0.3503 |
| | 0.3100 | 0.3270 | | 0.3221 | 0.3427 | | 0.3281 | 0.3597 |
| | 0.3160 | 0.3391 | | 0.3281 | 0.3548 | | 0.3342 | 0.3635 |
| | 0.3160 | 0.3261 | | 0.3281 | 0.3428 | | 0.3342 | 0.3624 |
| 5L0 | 0.3160 | 0.3186 | 6M0 | 0.3221 | 0.3382 | | | |
| | 0.3160 | 0.3306 | | 0.3221 | 0.3512 | | | |
| | 0.3221 | 0.3427 | | 0.3254 | 0.3578 | | | |
| | 0.3221 | 0.3307 | | 0.3281 | 0.3597 | | | |
| | | | | 0.3281 | 0.3503 | | | |

Group Name on Label

Example: T4-4L0-AB

| Brightness | Color Chromaticity | Forward Voltage |
|------------|--------------------|-----------------|
| T4 | 4L0 | AB |

Relative Spectral Emission ⁷⁾

$\Phi_{rel} = f(\lambda)$; $I_F = 1000 \text{ mA}$; $T_J = 25 \text{ }^\circ\text{C}$

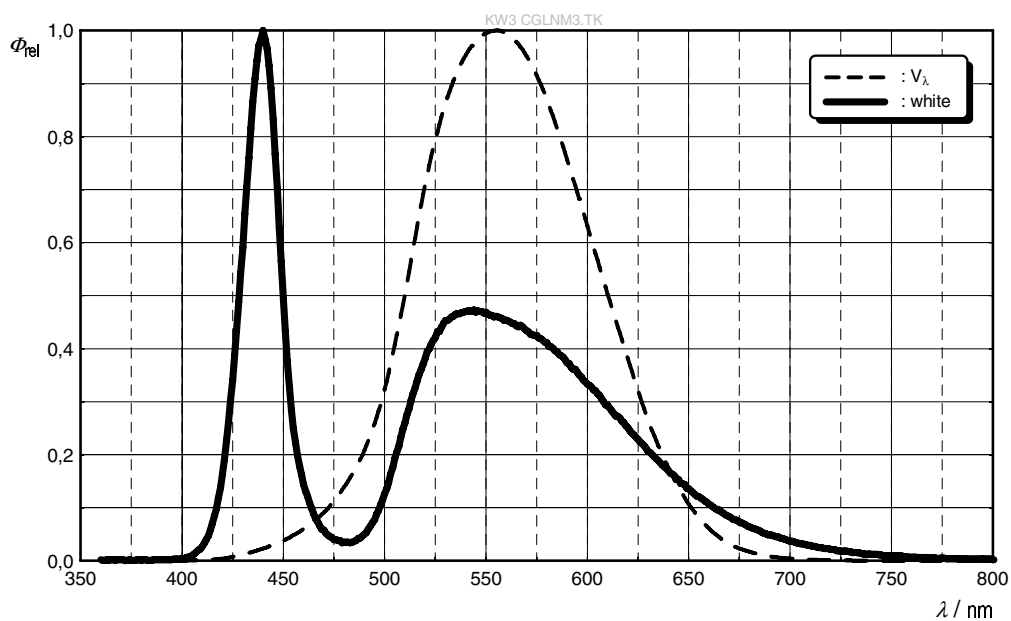

Radiation Characteristics ⁷⁾

$I_{rel} = f(\phi)$; $T_J = 25 \text{ }^\circ\text{C}$

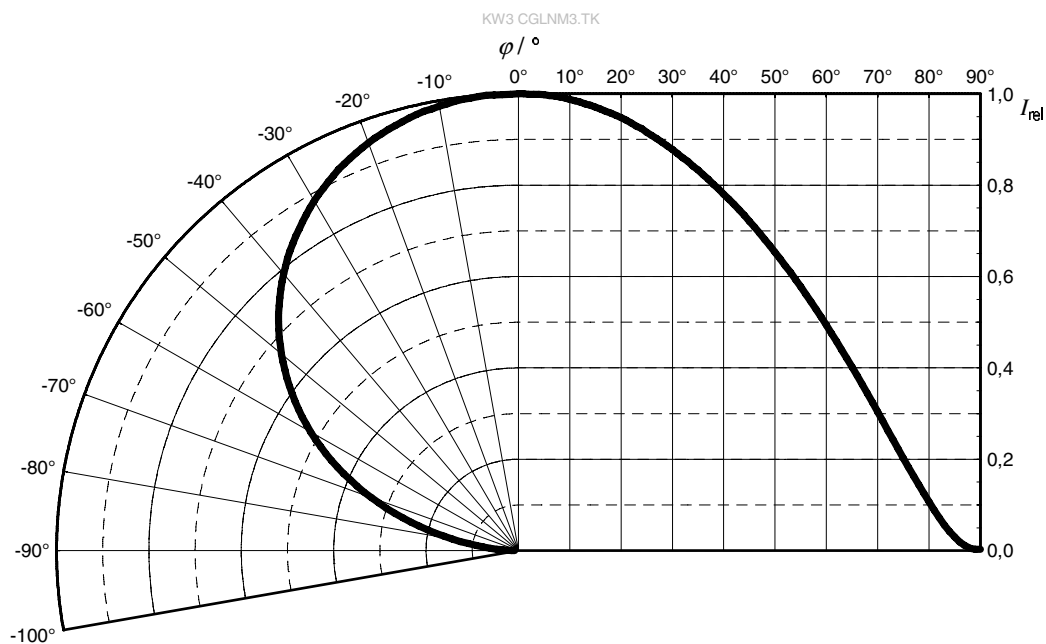

Forward current ⁷⁾

$$I_F = f(V_F); T_J = 25\text{ °C}$$

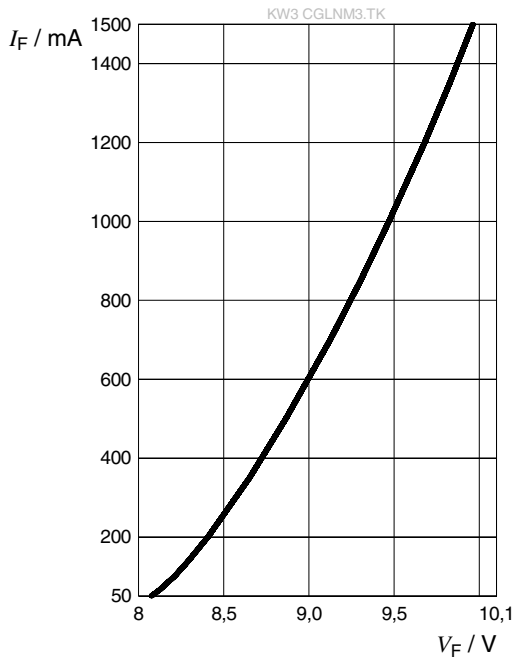

Relative Luminous Flux ^{7), 8)}

$$\Phi_V / \Phi_V(1000\text{ mA}) = f(I_F); T_J = 25\text{ °C}$$

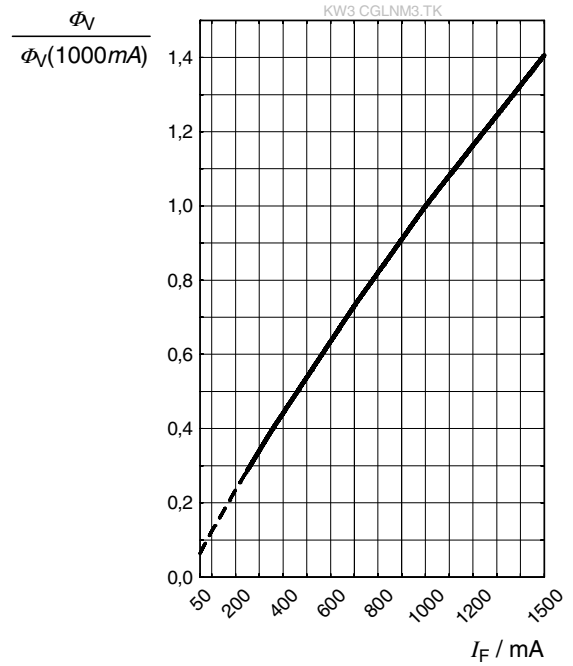

Chromaticity Coordinate Shift ⁷⁾

$$C_x, C_y = f(I_F); T_J = 25\text{ °C}$$

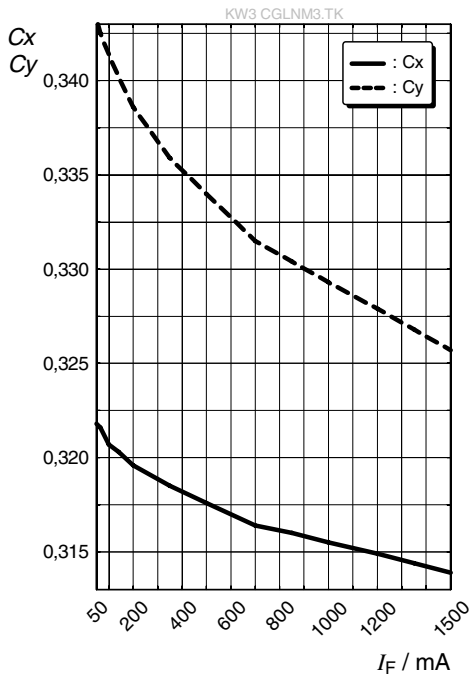

Forward Voltage ⁷⁾

$$\Delta V_F = V_F - V_F(25\text{ }^\circ\text{C}) = f(T_j); I_F = 1000\text{ mA}$$

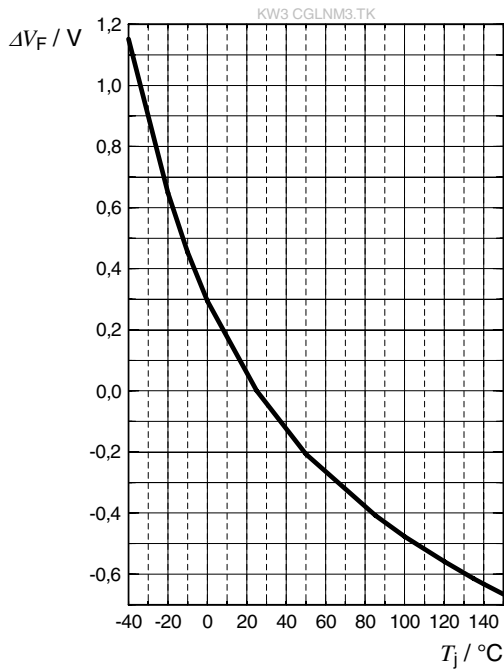

Relative Luminous Flux ⁷⁾

$$\Phi_V / \Phi_V(25\text{ }^\circ\text{C}) = f(T_j); I_F = 1000\text{ mA}$$

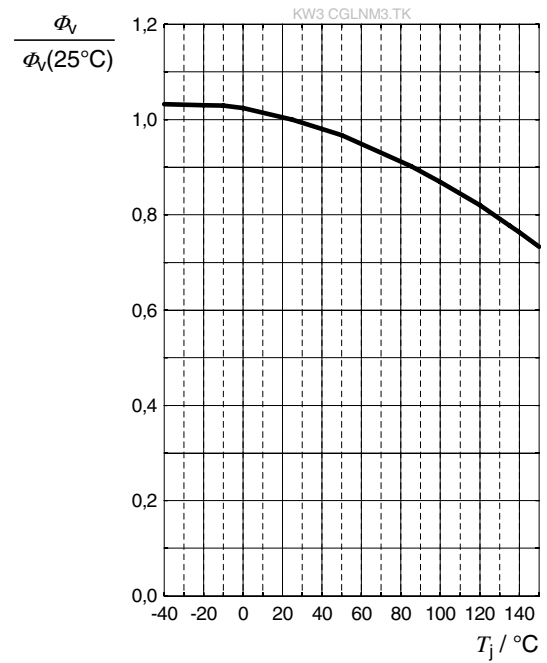

Chromaticity Coordinate Shift ⁷⁾

$$C_x, C_y = f(T_j); I_F = 1000\text{ mA}$$

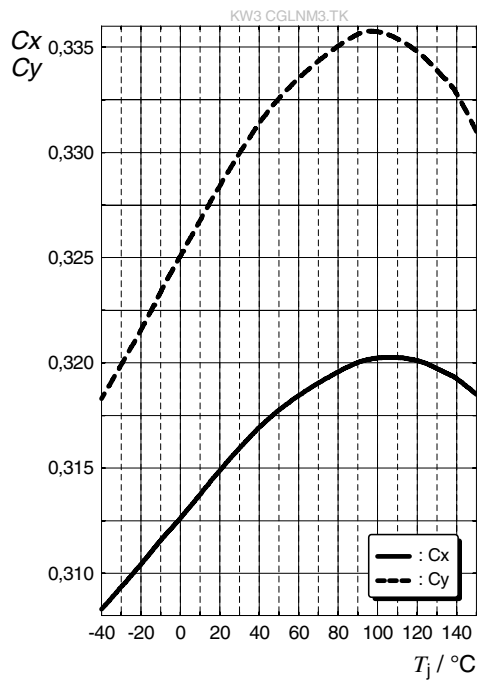

Max. Permissible Forward Current ⁶⁾

$$I_F = f(T)$$

FIGURE 10

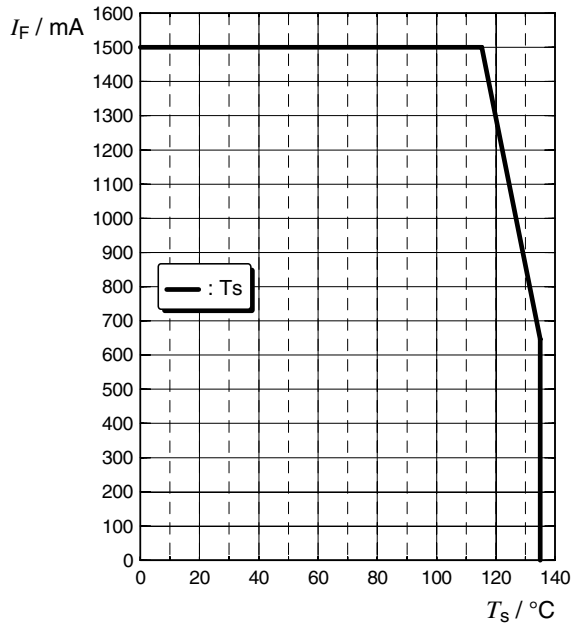

Dimensional Drawing ⁹⁾

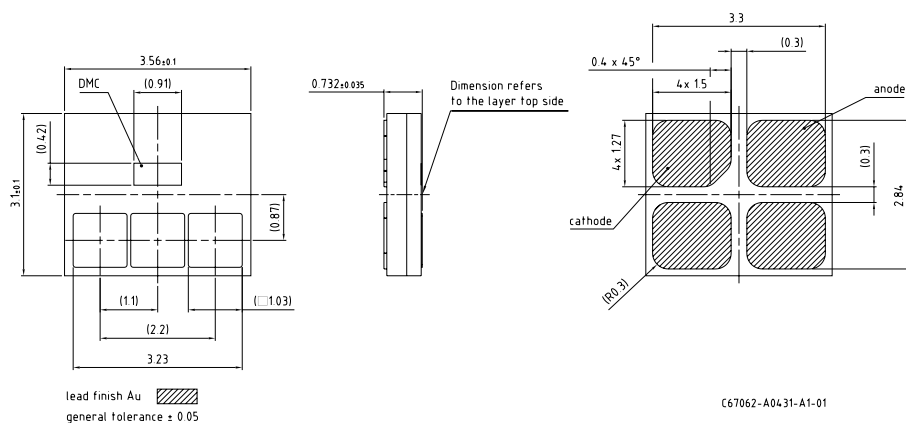

Further Information:

Approximate Weight: 28.5 mg

Corrosion test: Class: 3A
 Test condition: 40°C / 90 % RH / 15 ppm H₂S / 14 days (stricter than IEC 60068-2-43)

ESD advice: The device is protected by ESD device which is connected in parallel to the Chip.

Electrical Internal Circuit

ESD protection device

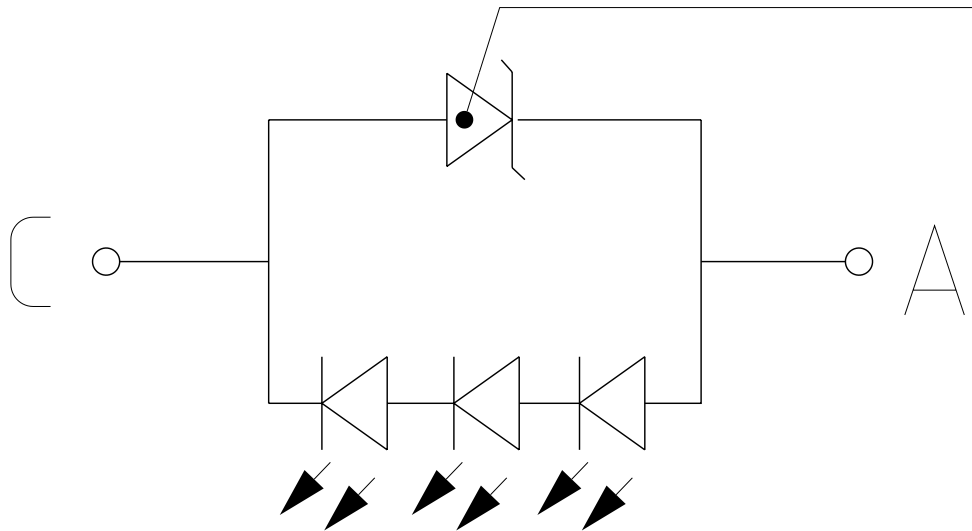

Recommended Solder Pad 9)

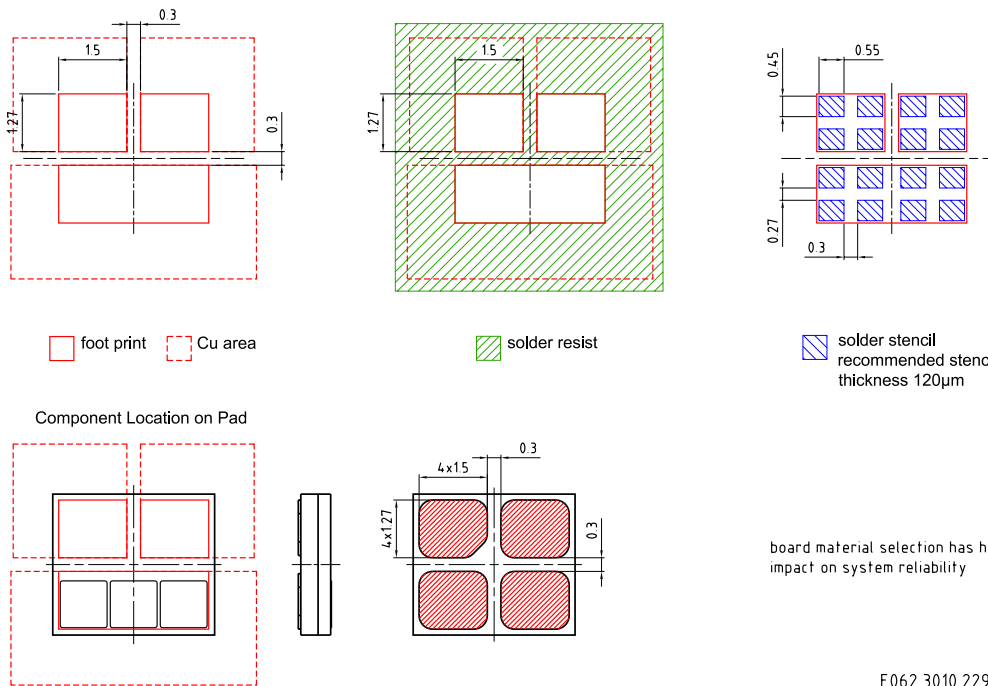

E062.3010.229-02

For superior solder joint connectivity results we recommend soldering under standard nitrogen atmosphere. Package not suitable for ultra sonic cleaning. To ensure a high solder joint reliability and to minimize the risk of solder joint cracks, the customer is responsible to evaluate the combination of PCB board and solder paste material for his application.

Reflow Soldering Profile

Product complies to MSL Level 2 acc. to JEDEC J-STD-020E

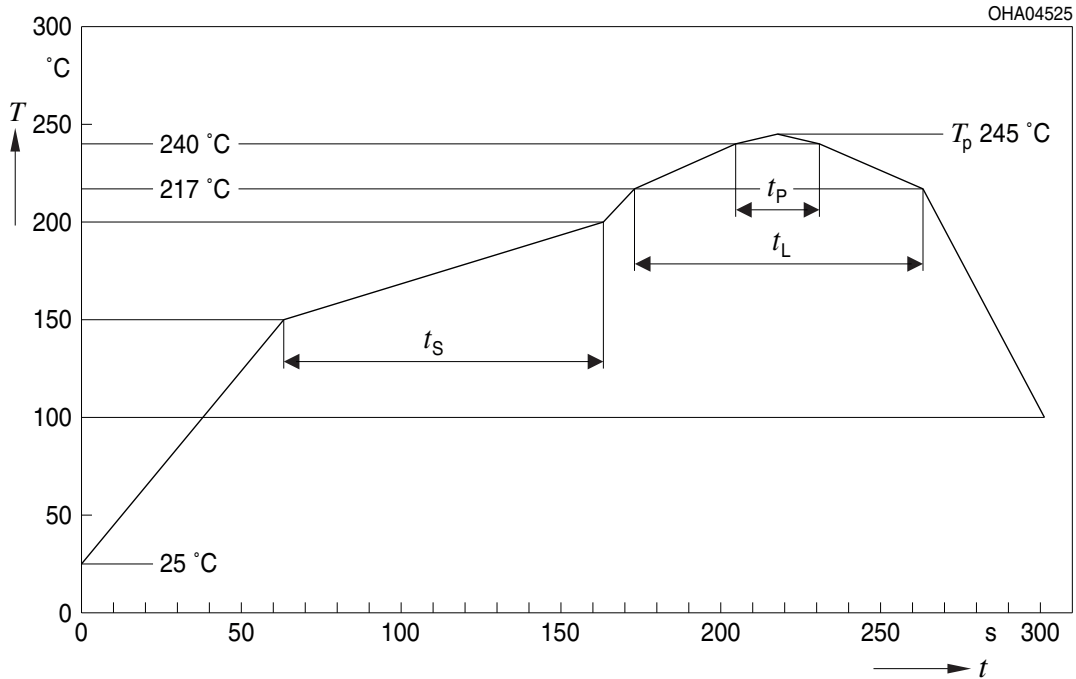

| Profile Feature | Symbol | Pb-Free (SnAgCu) Assembly | | | Unit |
|---|--------|---------------------------|----------------|---------|------|
| | | Minimum | Recommendation | Maximum | |
| Ramp-up rate to preheat ^{*)} 25 °C to 150 °C | | | 2 | 3 | K/s |
| Time t_s T_{Smin} to T_{Smax} | t_s | 60 | 100 | 120 | s |
| Ramp-up rate to peak ^{*)} T_{Smax} to T_p | | | 2 | 3 | K/s |
| Liquidus temperature | T_L | | 217 | | °C |
| Time above liquidus temperature | t_L | | 80 | 100 | s |
| Peak temperature | T_p | | 245 | 260 | °C |
| Time within 5 °C of the specified peak temperature $T_p - 5$ K | t_p | 10 | 20 | 30 | s |
| Ramp-down rate* T_p to 100 °C | | | 3 | 6 | K/s |
| Time 25 °C to T_p | | | | 480 | s |

All temperatures refer to the center of the package, measured on the top of the component

* slope calculation DT/Dt : Dt max. 5 s; fulfillment for the whole T-range

Tape and Reel ¹⁰⁾

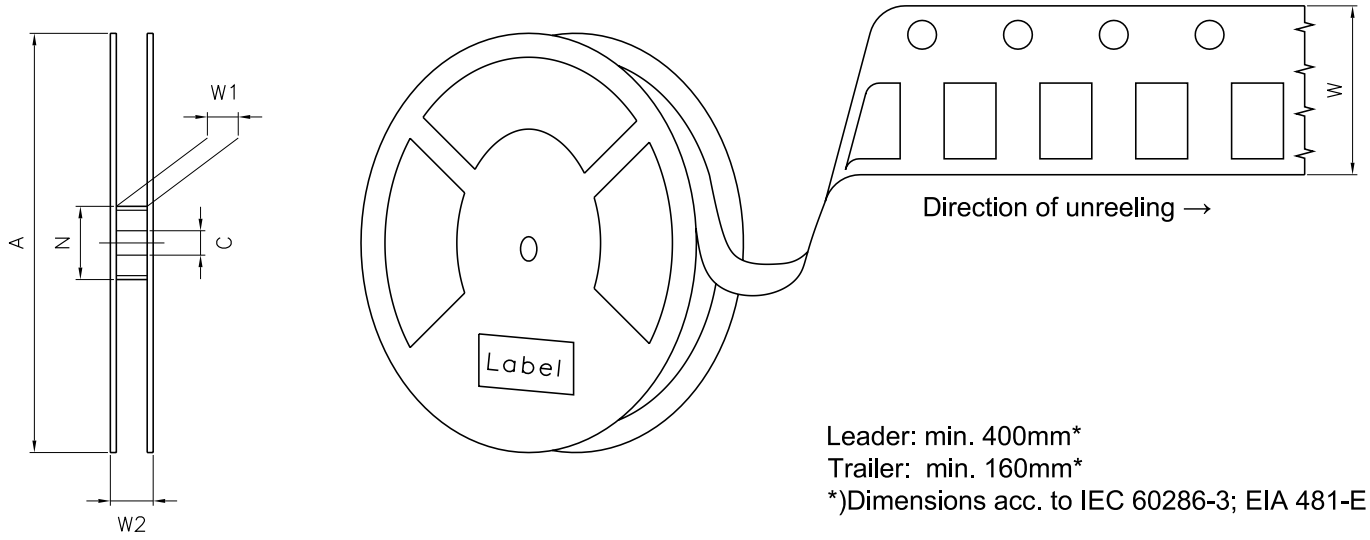

Reel Dimensions

| A | W | N _{min} | W ₁ | W _{2max} | Pieces per PU |
|--------|---------------------|------------------|----------------|-------------------|---------------|
| 180 mm | 12 + 0.3 / - 0.1 mm | 60 mm | 12.4 + 2 mm | 18.4 mm | 2000 |

Barcode-Product-Label (BPL)

OSRAM LX XXXX BIN1: XX-XX-X-XXX-X

RoHS Compliant

(6P) BATCH NO: 1234567890 ML Temp ST
X XXX °C X

(1T) LOT NO: 1234567890 (9D) D/C: 1234

Pack: RXX
DEMY XXX
X_X123_1234.1234 X

(X) PROD NO: 123456789(Q)QTY: 9999 (G) GROUP: XX-XX-X-X

OHA04563

Dry Packing Process and Materials ⁹⁾

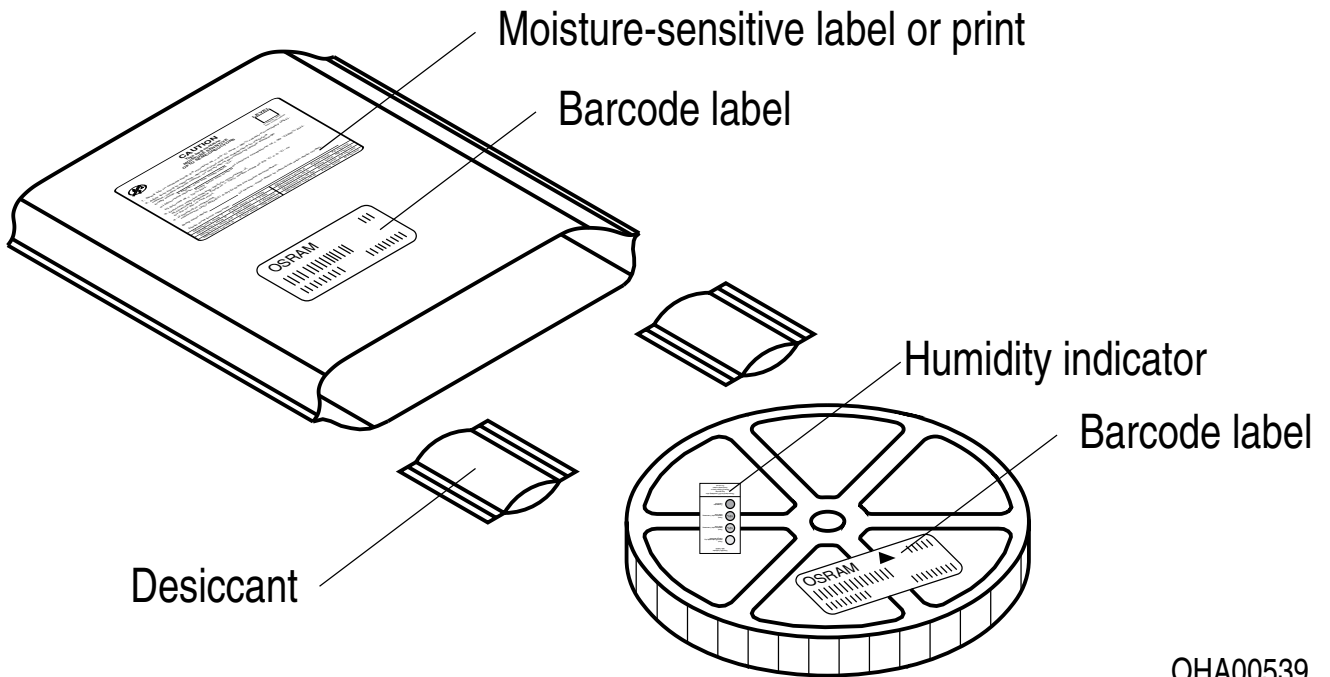

OHA00539

Moisture-sensitive product is packed in a dry bag containing desiccant and a humidity card according JEDEC-STD-033.

Notes

The evaluation of eye safety occurs according to the standard IEC 62471:2006 (photo biological safety of lamps and lamp systems). Within the risk grouping system of this IEC standard, the device specified in this data sheet fall into the class **moderate risk (exposure time 0.25 s)**. Under real circumstances (for exposure time, conditions of the eye pupils, observation distance), it is assumed that no endangerment to the eye exists from these devices. As a matter of principle, however, it should be mentioned that intense light sources have a high secondary exposure potential due to their blinding effect. When looking at bright light sources (e.g. headlights), temporary reduction in visual acuity and afterimages can occur, leading to irritation, annoyance, visual impairment, and even accidents, depending on the situation.

Subcomponents of this device contain, in addition to other substances, metal filled materials. Metal filled materials can be affected by environments that contain traces of aggressive substances. Therefore, we recommend that customers avoid device exposure to aggressive substances during storage, production, and use.

For further application related information please visit <https://ams-osram.com/support/application-notes>

Disclaimer

Attention please!

The information describes the type of component and shall not be considered as assured characteristics. Terms of delivery and rights to change design reserved. Due to technical requirements components may contain dangerous substances.

For information on the types in question please contact our Sales Organization.

If printed or downloaded, please find the latest version on our website.

Packing

Please use the recycling operators known to you. We can also help you – get in touch with your nearest sales office. By agreement we will take packing material back, if it is sorted. You must bear the costs of transport. For packing material that is returned to us unsorted or which we are not obliged to accept, we shall have to invoice you for any costs incurred.

Product and functional safety devices/applications or medical devices/applications

Our components are not developed, constructed or tested for the application as safety relevant component or for the application in medical devices.

Our products are not qualified at module and system level for such application.

In case buyer – or customer supplied by buyer – considers using our components in product safety devices/ applications or medical devices/applications, buyer and/or customer has to inform our local sales partner immediately and we and buyer and /or customer will analyze and coordinate the customer-specific request between us and buyer and/or customer.

Glossary

- 1) **Brightness:** Brightness values are measured during a current pulse of typically 1 ms, with an internal reproducibility of $\pm 8\%$ and an expanded uncertainty of $\pm 11\%$ (acc. to GUM with a coverage factor of $k = 3$).
- 2) **Operating Temperature:** The Operating Temperature T_{op} is referenced to the Solderpoint T_s of this device. Proper current derating must be observed to maintain junction temperature below the maximum.
- 3) **Reverse Operation:** This product is intended to be operated applying a forward current within the specified range. Applying any continuous reverse bias or forward bias below the voltage range of light emission shall be avoided because it may cause migration which can change the electro-optical characteristics or damage the LED.
- 4) **Chromaticity coordinate groups:** Chromaticity coordinates are measured during a current pulse of typically 1 ms, with an internal reproducibility of ± 0.005 and an expanded uncertainty of ± 0.01 (acc. to GUM with a coverage factor of $k = 3$).
- 5) **Forward Voltage:** The forward voltage is measured during a current pulse of typically 1 ms, with an internal reproducibility of $\pm 0.05\text{ V}$ and an expanded uncertainty of $\pm 0.1\text{ V}$ (acc. to GUM with a coverage factor of $k = 3$).
- 6) **Thermal Resistance:** $R_{th\ max}$ is based on statistic values (6σ) used for Derating.
- 7) **Typical Values:** Due to the special conditions of the manufacturing processes of semiconductor devices, the typical data or calculated correlations of technical parameters can only reflect statistical figures. These do not necessarily correspond to the actual parameters of each single product, which could differ from the typical data and calculated correlations or the typical characteristic line. If requested, e.g. because of technical improvements, these typ. data will be changed without any further notice.
- 8) **Characteristic curve:** In the range where the line of the graph is broken, you must expect higher differences between single devices within one packing unit.
- 9) **Tolerance of Measure:** Unless otherwise noted in drawing, tolerances are specified with ± 0.1 and dimensions are specified in mm.
- 10) **Tape and Reel:** All dimensions and tolerances are specified acc. IEC 60286-3 and specified in mm.

Revision History

| Version | Date | Change |
|---------|------------|-----------------|
| 1.0 | 2023-05-26 | Initial Version |



EU RoHS and China RoHS compliant product

此产品符合欧盟 RoHS 指令的要求；
按照中国的相关法规和标准，
不含有毒有害物质或元素。

Published by ams-OSRAM AG

Tobelbader Strasse 30, 8141 Premstaetten, Austria

Phone +43 3136 500-0

ams-osram.com

© All rights reserved

am 

OSRAM