

OSRAM LE CG P3AQ

Datasheet

Published by **ams-OSRAM AG**

Tobelbader Strasse 30, 8141 Premstaetten, Austria

Phone +43 3136 500-0

ams-osram.com

© All rights reserved



OSRAM OSTAR™ Projection Power

LE CG P3AQ

OSRAM OSTAR Projection Power is a high luminance LED for projection applications.

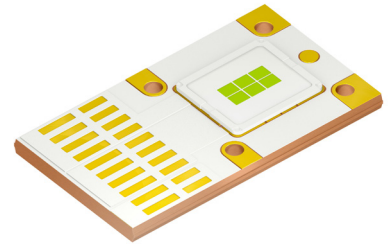

Applications

- Projection & display
- Visualization

Features

- Package: OSTAR High Power Projection
- Chip technology: UX:3
- Typ. Radiation: 120° (Lambertian emitter)
- Color: Cx = 0.32, Cy = 0.64 acc. to CIE 1931 (● converted green)
- ESD: 2 kV acc. to ANSI/ESDA/JEDEC JS-001 (HBM, Class 2)

Ordering Information

Type	Luminous Flux ¹⁾ $I_F = 10000 \text{ mA}$ Φ_V	Ordering Code
LE CG P3AQ-XQXT-A	19400 ... 25900 lm	Q65115A2047

Maximum Ratings

Parameter	Symbol		Values
Storage Temperature	T_{stg}	min. max.	-40 °C 85 °C
Junction Temperature	T_j	max.	150 °C
Forward Current $T_j = T_{j,max}$	I_F	min. max.	200 mA 10000 mA
Forward Current pulsed $D = 0.7; f = 240 \text{ Hz}; T_j = T_{j,max}$	$I_{F \text{ pulse}}$		12000 mA
Surge Current $t_p \leq 50 \mu\text{s}; D = 0.1; T_j = T_{j,max}$	I_{FS}	max.	14000 mA
ESD withstand voltage acc. to ANSI/ESDA/JEDEC JS-001 (HBM, Class 2)	V_{ESD}		2 kV
Reverse current ²⁾	I_R	max.	200 mA
Max. voltage difference anode-board, cathode-board	$\Delta V_{a-b}, \Delta V_{c-b}$	max.	40 V

Characteristics

$I_F = 10000 \text{ mA}$; $T_B = 25 \text{ °C}$

Parameter	Symbol		Values
Chromaticity Coordinate ³⁾ within $\lambda = 500 \dots 600 \text{ nm}$	C_x	typ.	0.32
	C_y	typ.	0.64
Peak Wavelength	λ_{peak}	typ.	520 nm
Spectral bandwidth at 50% $I_{\text{rel,max}}$	$\Delta\lambda$	typ.	93 nm
Viewing angle at 50% I_V	2ϕ	typ.	120 °
Radiating surface	A_{color}	typ.	4.85 x 2.6 mm ²
Partial Flux acc. CIE 127:2007 ⁴⁾ $I_F = 10000 \text{ mA}$	$\Phi_{E/V, 120^\circ}$	typ.	0.77
Forward Voltage ⁵⁾ $I_F = 10000 \text{ mA}$	V_F	min.	21.0 V
		typ.	24.0 V
		max.	27.0 V
Reverse voltage (ESD device)	$V_{R\text{ESD}}$	min.	45 V
Reverse voltage ²⁾ $I_R = 20 \text{ mA}$	V_R	max.	1.2 V
Real thermal resistance junction/board	$R_{\text{thJB real}}$	typ.	0.45 K / W
Electrical thermal resistance junction/board with efficiency $\eta_e = 23 \%$	$R_{\text{thJB elec.}}$	typ.	0.35 K / W

Brightness Groups

Group	Luminous Flux ¹⁾ $I_F = 10000 \text{ mA}$ min. Φ_V	Luminous Flux ¹⁾ $I_F = 10000 \text{ mA}$ max. Φ_V
XQ	19400 lm	21000 lm
XR	21000 lm	22400 lm
XS	22400 lm	24000 lm
XT	24000 lm	25900 lm

Chromaticity Coordinate Groups

within $\lambda = 500 \dots 600 \text{ nm}$

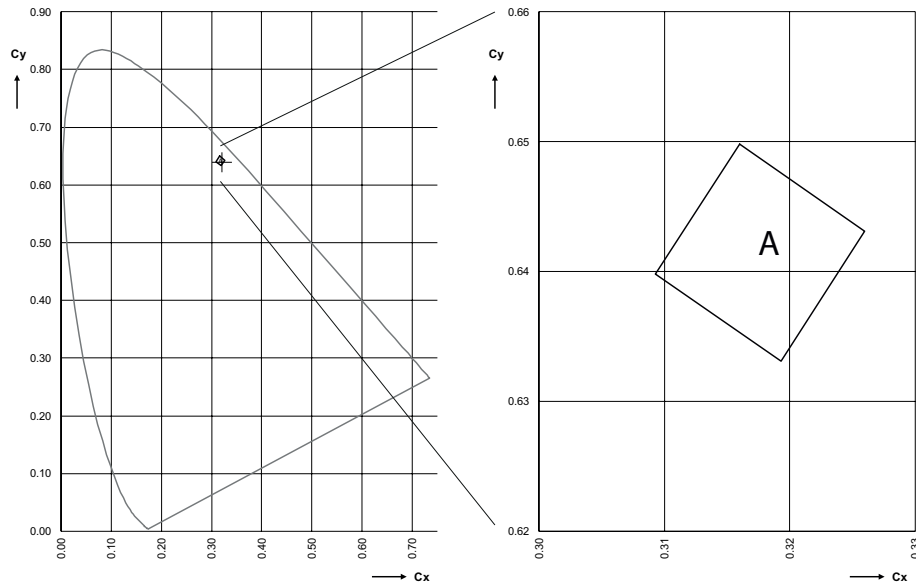

Chromaticity Coordinate Groups ³⁾

Group	Cx	Cy
A	0.3093	0.6398
	0.3160	0.6498
	0.3260	0.6431
	0.3193	0.6331

Group Name on Label

Example: XQ-A

Brightness

Color Chromaticity

XQ

A

Relative Spectral Emission ⁴⁾

$\Phi_{rel} = f(\lambda); I_F = 10000 \text{ mA}; T_J = 25 \text{ }^\circ\text{C}$

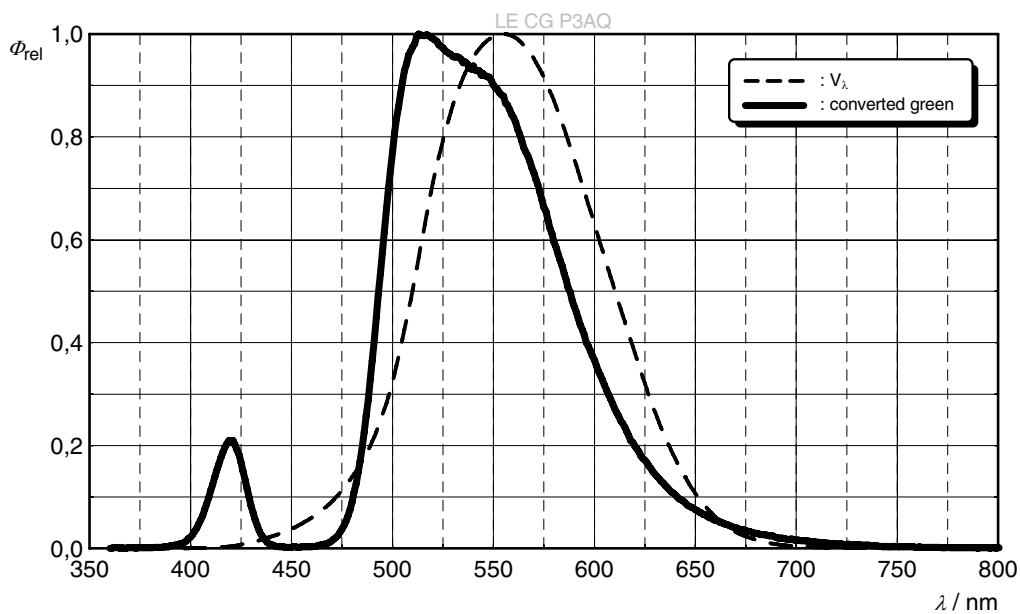

Radiation Characteristics ⁴⁾

$I_{rel} = f(\varphi); T_J = 25 \text{ }^\circ\text{C}$

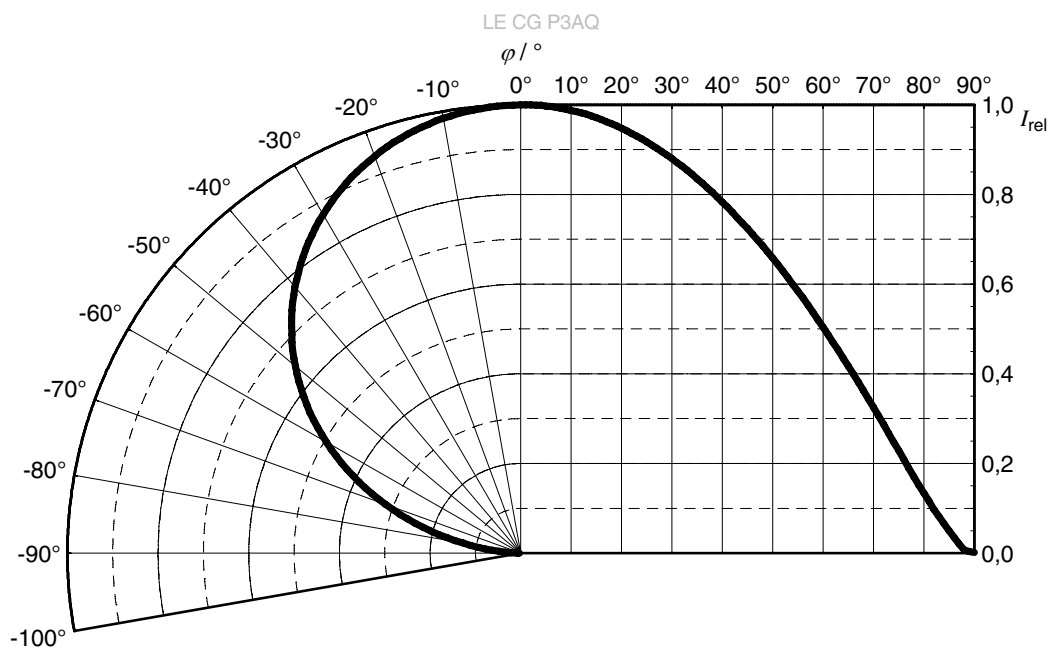

Relative Partial Flux ⁴⁾

$$\Phi_V(2\varphi)/\Phi_V(180^\circ) = f(\varphi); T_J = 25^\circ\text{C}$$

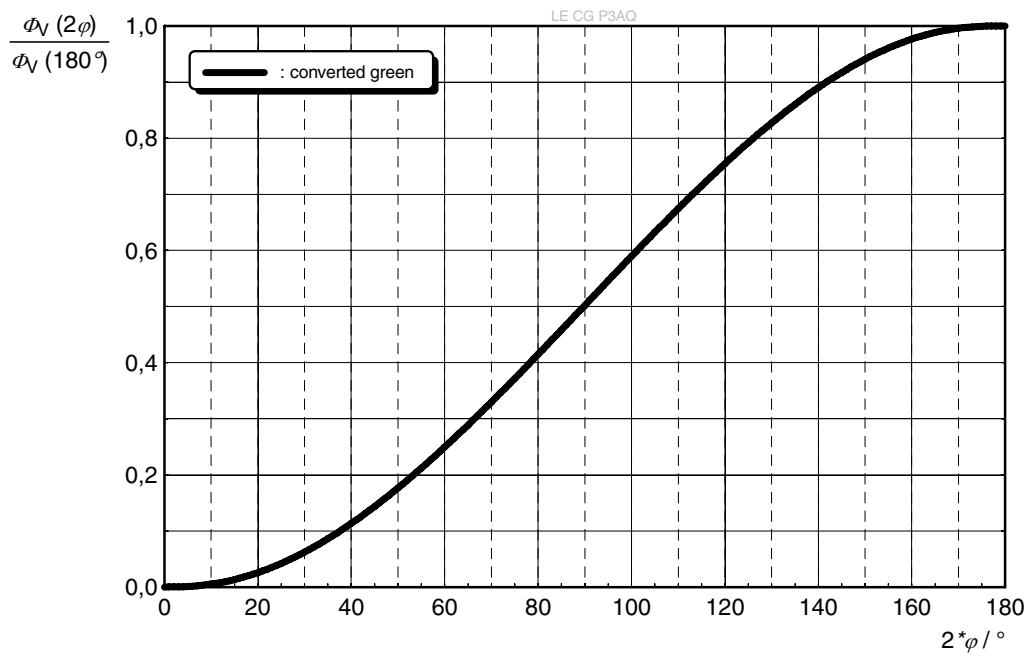

Relative cumulated Luminous Flux ⁴⁾

$$\Phi_{Vrel-cum} = f(\lambda); I_F = 10000 \text{ mA}; T_J = 25^\circ\text{C}$$

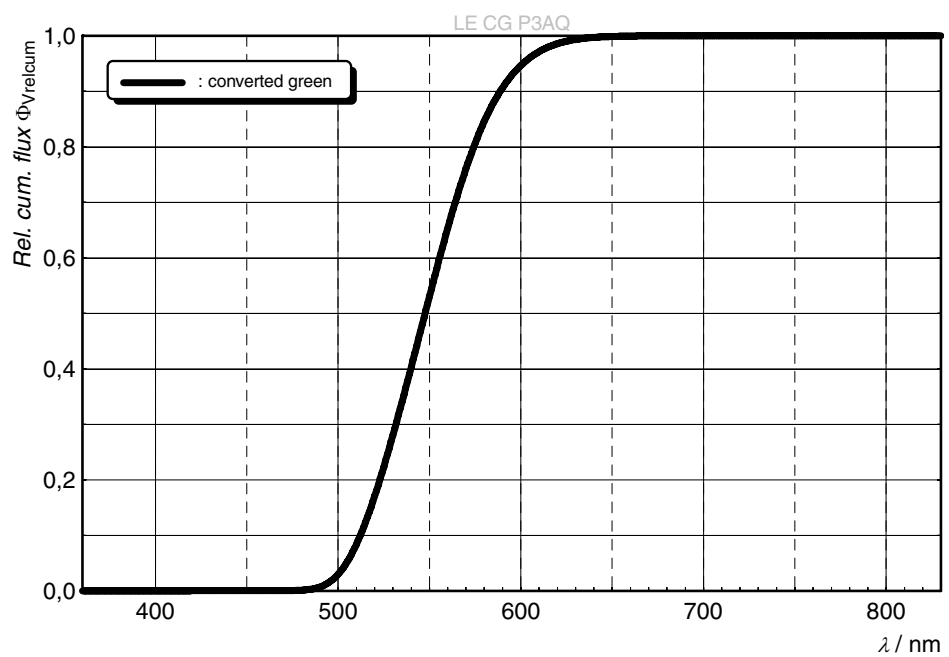

Forward current ⁴⁾

$I_F = f(V_F); T_J = 25\text{ °C}$

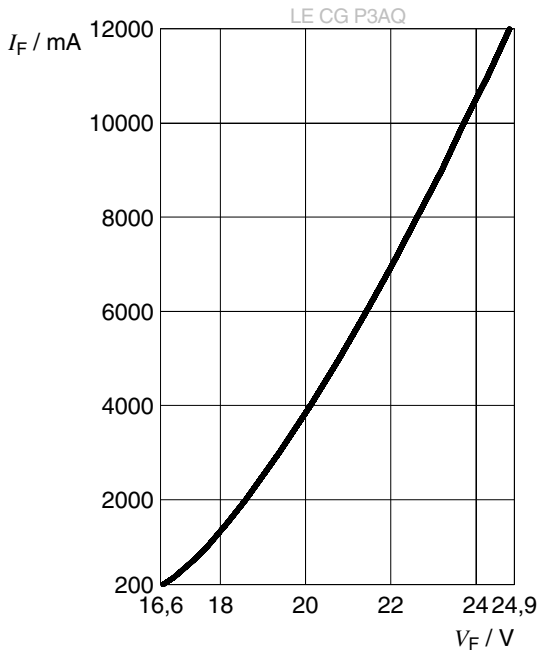

Relative Luminous Flux ^{4), 6)}

$\Phi_V / \Phi_V(10000\text{ mA}) = f(I_F); T_J = 25\text{ °C}$

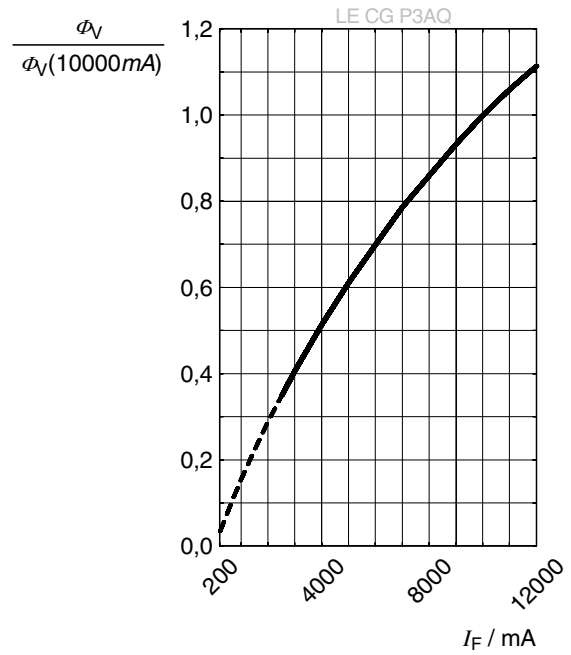

Chromaticity Coordinate Shift ⁴⁾

$\Delta C_x, \Delta C_y = f(I_F); T_J = 25\text{ °C};$
within $\lambda = 500 \dots 600\text{ nm}$

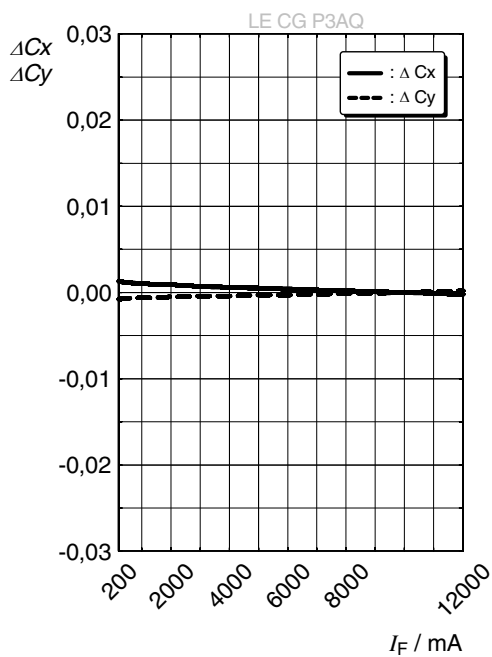

Chromaticity Coordinate Shift ⁴⁾

$\Delta C_x, \Delta C_y = f(I_F); T_J = 25\text{ °C}$

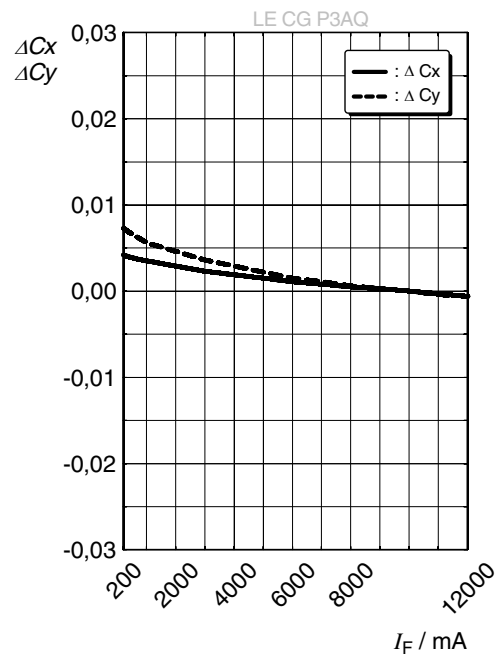

Forward Voltage ⁴⁾

$$\Delta V_F = V_F - V_F(25\text{ }^\circ\text{C}) = f(T_j); I_F = 10000\text{ mA}$$

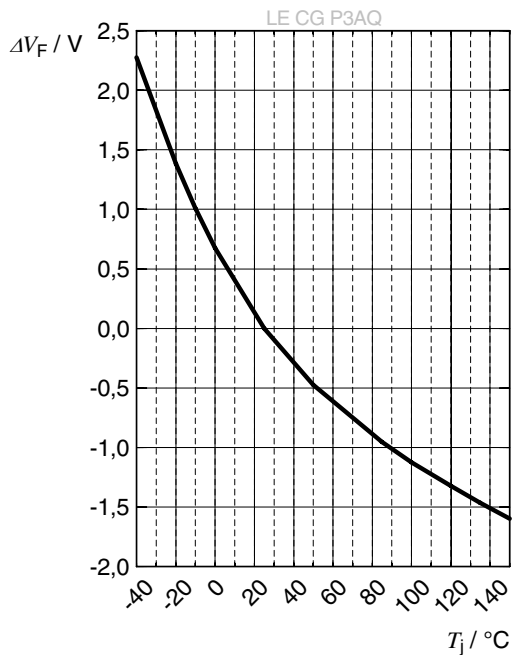

Relative Luminous Flux ⁴⁾

$$\Phi_v / \Phi_v(25\text{ }^\circ\text{C}) = f(T_j); I_F = 10000\text{ mA}$$

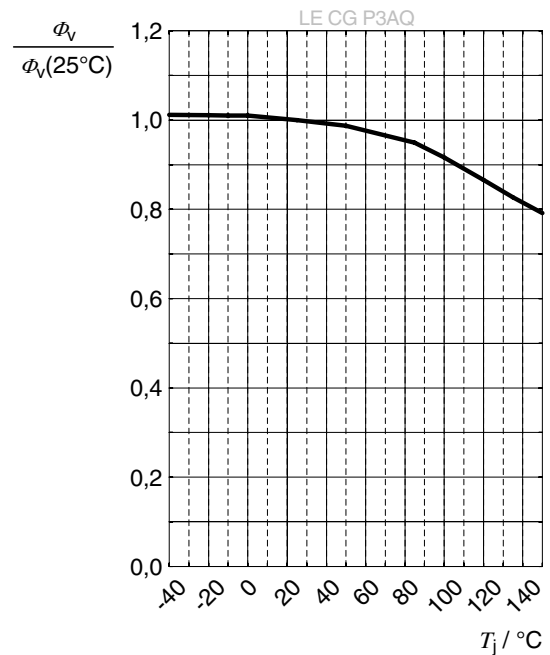

Chromaticity Coordinate Shift ⁴⁾

$$\Delta C_x, \Delta C_y = f(T_j); I_F = 10000\text{ mA}$$

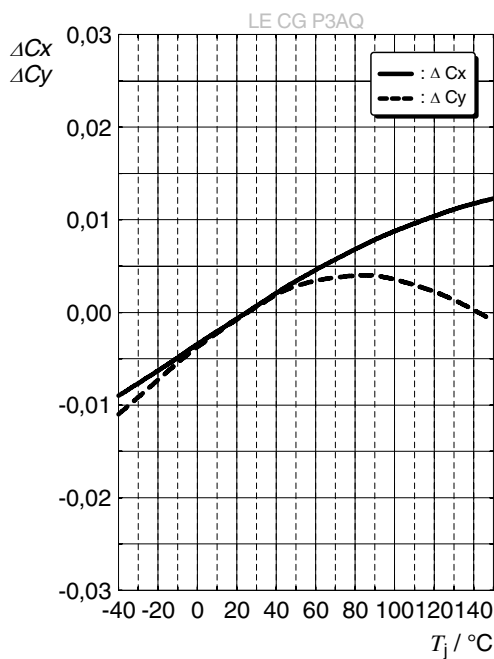

Chromaticity Coordinate Shift ⁴⁾

$$\Delta C_x, \Delta C_y = f(T_j); I_F = 10000\text{ mA};$$

within $\lambda = 500 \dots 600\text{ nm}$

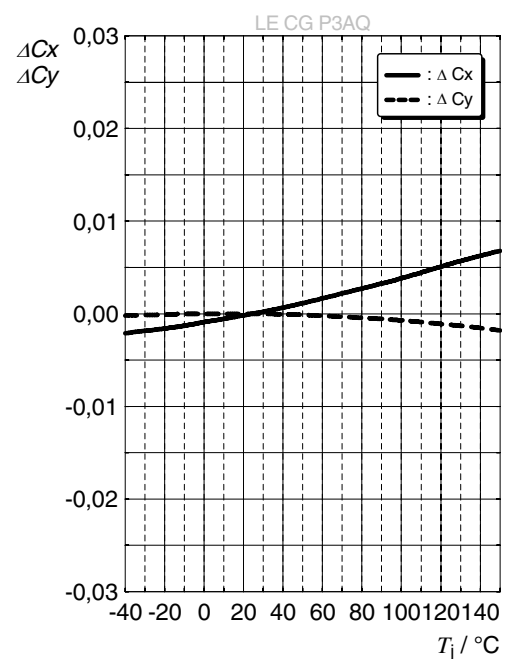

Dimensional Drawing 7)

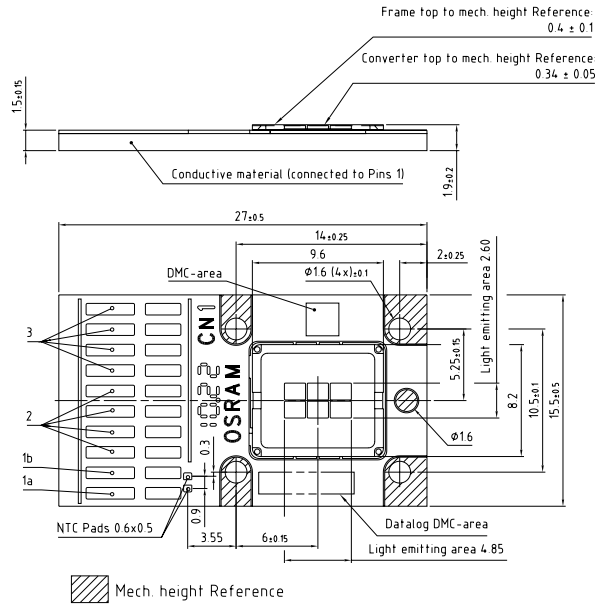

C63062-A4389-A3-06

Further Information:

Approximate Weight: 5,000.0 mg

ESD advice: The device is protected by ESD device which is connected in parallel to the Chip.

Notes: For superior solder joint connectivity results we recommend soldering under standard nitrogen atmosphere.

Package not suitable for any kind of wet cleaning or ultrasonic cleaning.

Connector: Molex Pico-SPOX™ Wire-to-Board Header, Part Number 87438-1043

Recommended mating connector: Molex Pico-SPOX™ Wire-to-Board Housing, Part Number 87439-1000
Crimp Terminal, Part Number 87421-0000

Electrical Internal Circuit

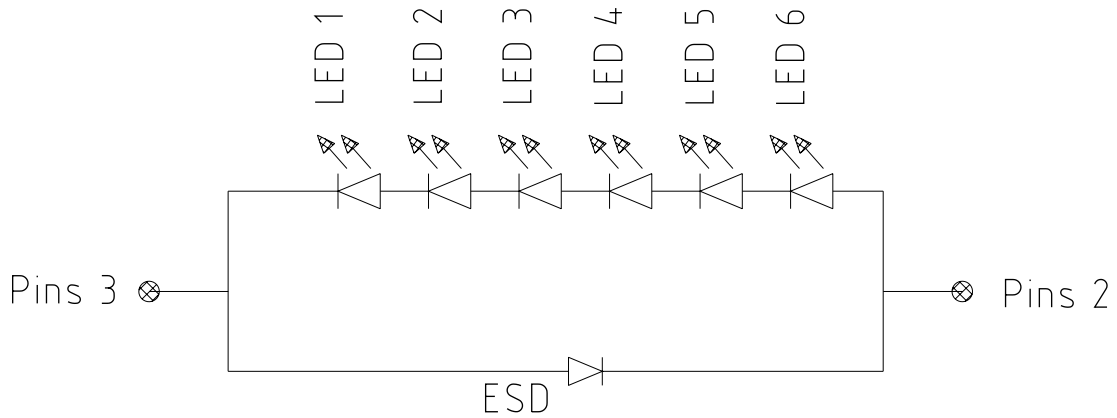

Pins 1a: NTC/Substrate potential, isolated from Cathode and Anode

Pins 1b: NTC

Pins 2: Anode

Pins 3: Cathode

Reflow Soldering Profile

Product complies to MSL Level 2 acc. to JEDEC J-STD-020E



Profile Feature	Symbol	Pb-Free (SnAgCu) Assembly			Unit
		Minimum	Recommendation	Maximum	
Ramp-up rate to preheat ^{*)} 25 °C to 150 °C			2	3	K/s
Time t_s T_{Smin} to T_{Smax}	t_s	60	100	120	s
Ramp-up rate to peak ^{*)} T_{Smax} to T_p			2	3	K/s
Liquidus temperature	T_L		217		°C
Time above liquidus temperature	t_L		80	100	s
Peak temperature	T_p		245	260	°C
Time within 5 °C of the specified peak temperature $T_p - 5$ K	t_p	10	20	30	s
Ramp-down rate* T_p to 100 °C			3	6	K/s
Time 25 °C to T_p				480	s

All temperatures refer to the center of the package, measured on the top of the component

* slope calculation DT/Dt : Dt max. 5 s; fulfillment for the whole T-range

Tray ⁷⁾

38 pieces per tray

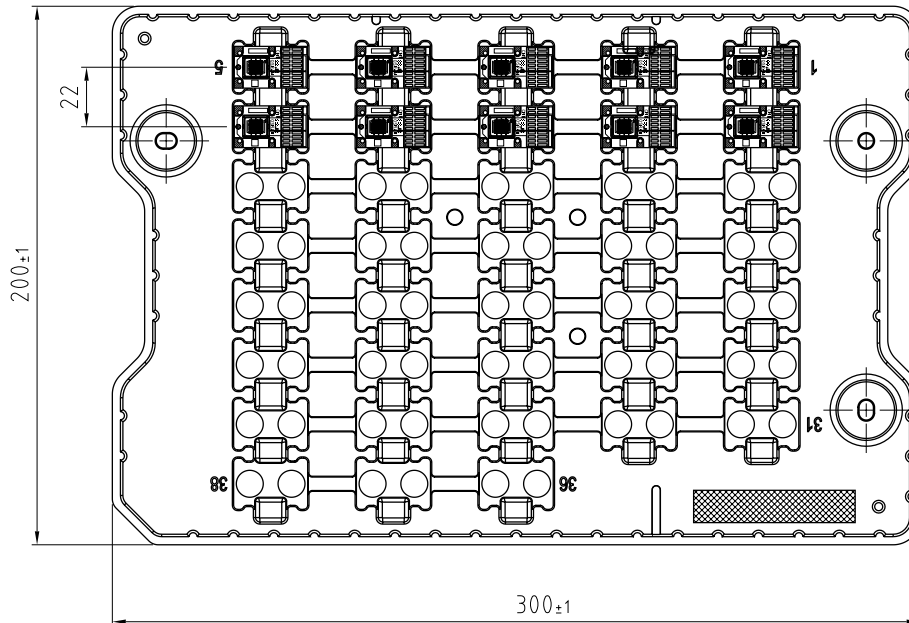

C63062-A4389-B10-01

Barcode-Product-Label (BPL)

OSRAM LX XXXX BIN1: XX-XX-X-XXX-X

RoHS Compliant





(6P) BATCH NO: 1234567890

(1T) LOT NO: 1234567890 (9D) D/C: 1234

(X) PROD NO: 123456789 (Q) QTY: 9999 (G) GROUP: XX-XX-X-X

ML Temp ST
X XXX °C X

Pack: RXX
DEMY XXX
X_X123_1234.1234 X



OHA04563



Barcode-Tray-Label (BTL)

LE xxx xxx Group: xxxx-xxxx-xxxx

Data Matrix Code

xxxx BIN

MATERIAL: Material Number Batch Batch Number BIN: xxxx



OHA02684_1

Schematic Transportation Box ⁷⁾

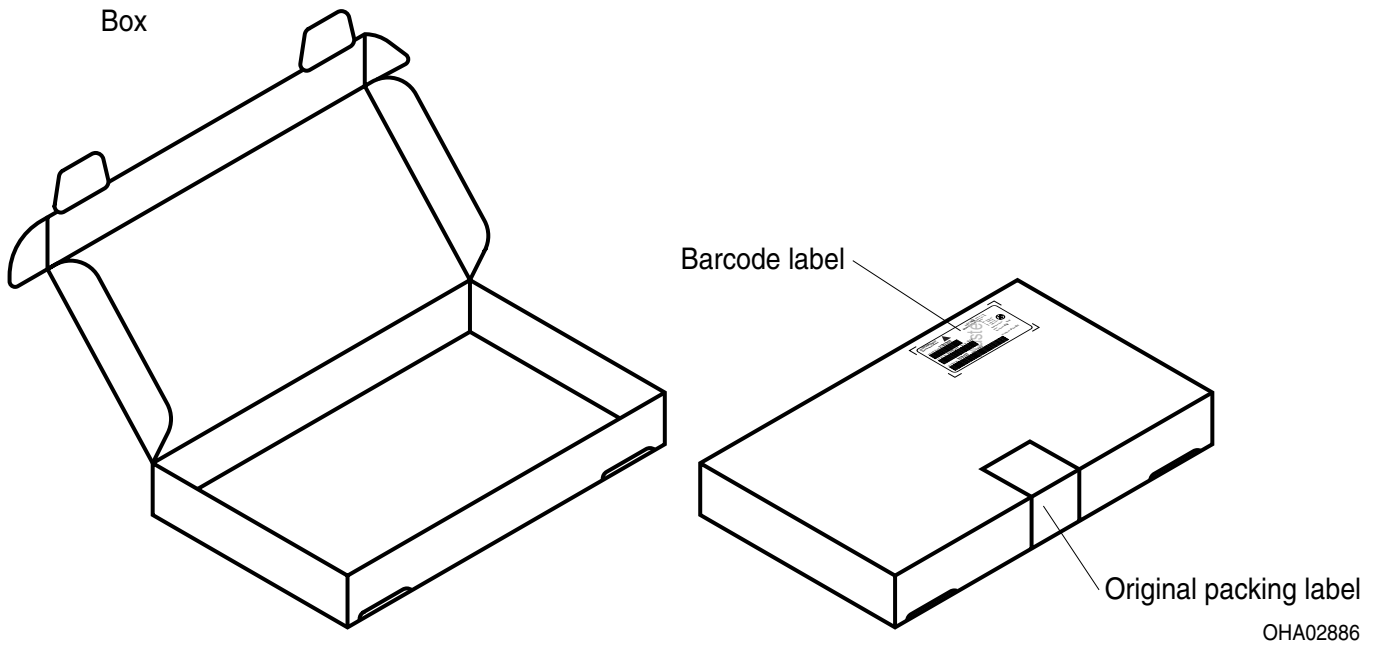

Dimensions of Transportation Box

Width	Length	Height
333 ± 5 mm	218 ± 5 mm	28 ± 5 mm
337 ± 5 mm	218 ± 5 mm	63 ± 5 mm

Data Matrix Code Description

The Data Matrix Code bin information is Laser marked during testing

Content: aaaa@bbbb@ccc@ddddd@eeee

Data Matrix Code Type: ECC200

a = Luminous Flux (Phiv) [lm] or Radiant Flux (Phie) [W] (example: 3306)

b = Forward Voltage (Vf) [V] (example: 3.46)

c = Wavelength (Ldom) [nm] (example: 618)

d = Color Coordinate Cx (example: 0.321)

e = Color Coordinate Cy (example: 0.641)

@: Seperator = Blank

Type Designation System

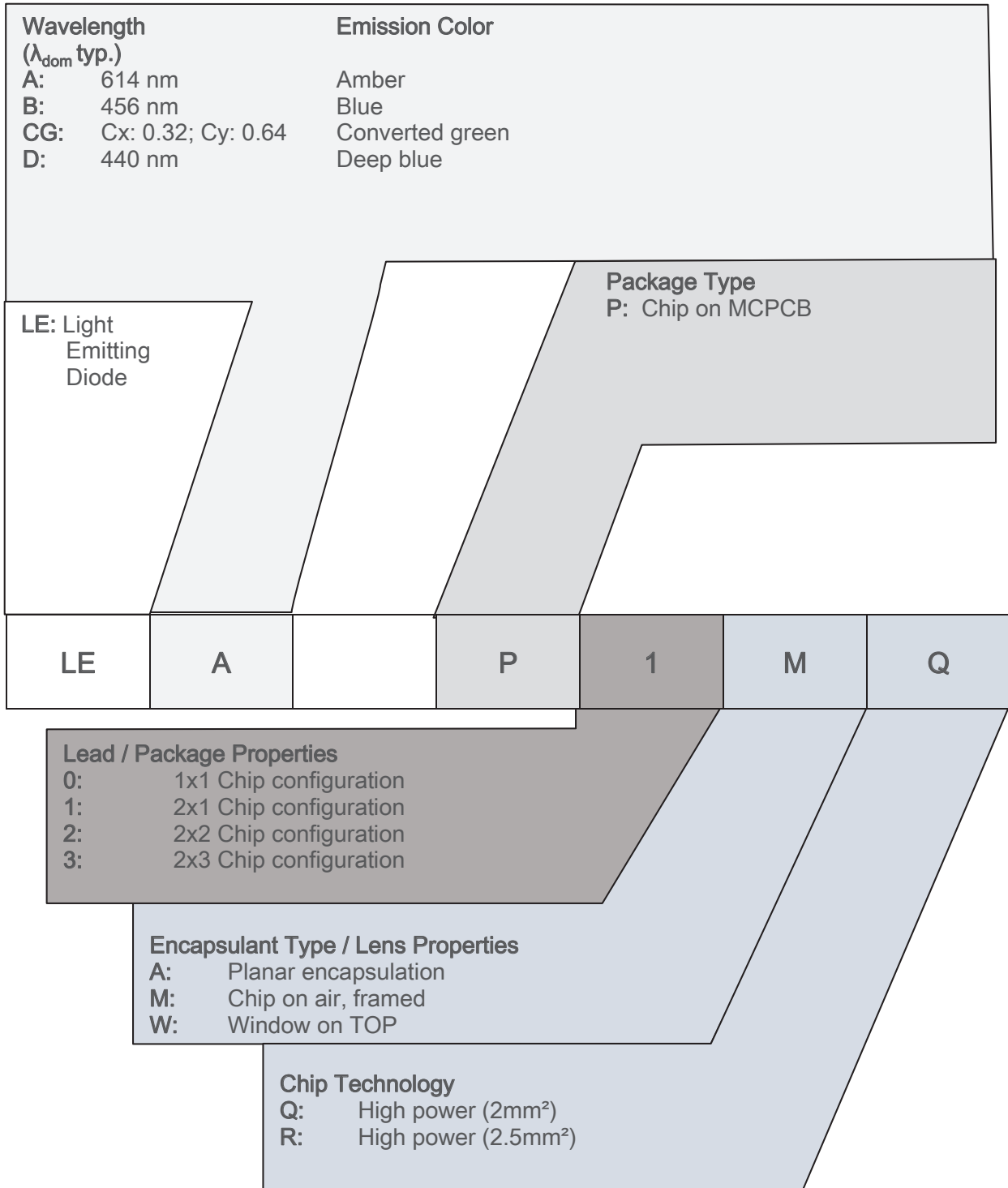

Notes

The evaluation of eye safety occurs according to the standard IEC 62471:2006 (photo biological safety of lamps and lamp systems). Within the risk grouping system of this IEC standard, the device specified in this data sheet fall into the class **moderate risk (exposure time 0.25 s)**. Under real circumstances (for exposure time, conditions of the eye pupils, observation distance), it is assumed that no endangerment to the eye exists from these devices. As a matter of principle, however, it should be mentioned that intense light sources have a high secondary exposure potential due to their blinding effect. When looking at bright light sources (e.g. headlights), temporary reduction in visual acuity and afterimages can occur, leading to irritation, annoyance, visual impairment, and even accidents, depending on the situation.

Subcomponents of this device contain, in addition to other substances, metal filled materials including silver. Metal filled materials can be affected by environments that contain traces of aggressive substances. Therefore, we recommend that customers minimize device exposure to aggressive substances during storage, production, and use. Devices that showed visible discoloration when tested using the described tests above did show no performance deviations within failure limits during the stated test duration. Respective failure limits are described in the IEC60810.

For further application related information please visit <https://ams-osram.com/support/application-notes>

Disclaimer

Attention please!

The information describes the type of component and shall not be considered as assured characteristics. Terms of delivery and rights to change design reserved. Due to technical requirements components may contain dangerous substances.

For information on the types in question please contact our Sales Organization.

If printed or downloaded, please find the latest version on our website.

Packing

Please use the recycling operators known to you. We can also help you – get in touch with your nearest sales office. By agreement we will take packing material back, if it is sorted. You must bear the costs of transport. For packing material that is returned to us unsorted or which we are not obliged to accept, we shall have to invoice you for any costs incurred.

Product and functional safety devices/applications or medical devices/applications

Our components are not developed, constructed or tested for the application as safety relevant component or for the application in medical devices.

Our products are not qualified at module and system level for such application.

In case buyer – or customer supplied by buyer – considers using our components in product safety devices/ applications or medical devices/applications, buyer and/or customer has to inform our local sales partner immediately and we and buyer and /or customer will analyze and coordinate the customer-specific request between us and buyer and/or customer.

Glossary

- 1) **Brightness:** Brightness values are measured during a current pulse of typically 1 ms, with an internal reproducibility of $\pm 8\%$ and an expanded uncertainty of $\pm 11\%$ (acc. to GUM with a coverage factor of $k = 3$).
- 2) **Reverse Operation:** This product is intended to be operated applying a forward current within the specified range. Applying any continuous reverse bias or forward bias below the voltage range of light emission shall be avoided because it may cause migration which can change the electro-optical characteristics or damage the LED.
- 3) **Chromaticity coordinate groups:** Chromaticity coordinates are measured during a current pulse of typically 1 ms, with an internal reproducibility of ± 0.005 and an expanded uncertainty of ± 0.01 (acc. to GUM with a coverage factor of $k = 3$).
- 4) **Typical Values:** Due to the special conditions of the manufacturing processes of semiconductor devices, the typical data or calculated correlations of technical parameters can only reflect statistical figures. These do not necessarily correspond to the actual parameters of each single product, which could differ from the typical data and calculated correlations or the typical characteristic line. If requested, e.g. because of technical improvements, these typ. data will be changed without any further notice.
- 5) **Forward Voltage:** The forward voltage is measured during a current pulse of typically 1 ms, with an internal reproducibility of $\pm 0.05\text{ V}$ and an expanded uncertainty of $\pm 0.1\text{ V}$ (acc. to GUM with a coverage factor of $k = 3$).
- 6) **Characteristic curve:** In the range where the line of the graph is broken, you must expect higher differences between single devices within one packing unit.
- 7) **Tolerance of Measure:** Unless otherwise noted in drawing, tolerances are specified with ± 0.1 and dimensions are specified in mm.

Revision History

Version	Date	Change
1.1	2019-09-26	Dimensional Drawing
1.1	2020-02-25	Maximum Ratings Characteristics
1.2	2020-09-16	Ordering Information Brightness Groups Characteristics
1.3	2021-03-26	Ordering Information Brightness Groups Characteristics Maximum Ratings Dimensional Drawing
1.3	2021-03-26	Additional Information
1.4	2021-07-15	Electro - Optical Characteristics (Diagrams) Chromaticity Coordinate Groups
1.5	2025-11-05	Applications Ordering Information Characteristics Brightness Groups Electro - Optical Characteristics (Diagrams) Dimensional Drawing Electrical Internal Circuit New Layout
1.6	2026-01-29	Dimensional Drawing



EU RoHS and China RoHS compliant product

此产品符合欧盟 RoHS 指令的要求；
按照中国的相关法规和标准，
不含有毒有害物质或元素。

Published by ams-OSRAM AG

Tobelbader Strasse 30, 8141 Premstaetten, Austria

Phone +43 3136 500-0

ams-osram.com

© All rights reserved

am 

OSRAM