



Light is motion

Light range 2019/2020

Global No.1 in Automotive Lighting

Light is OSRAM

**OSRAM**

# Quite simply the best solution

OSRAM provides the perfect vehicle lamp for every use and every requirement, be it in cars, motorcycles, trucks or off-road, be it LED, xenon or halogen, and whether for performance or design-oriented drivers.

Category	Highlight Feature	ECE/Range	Page
Global No.1 in Automotive Lighting			04
New packaging concept			05
Change lamps in pairs			06
LED portfolio overview			08
Xenon portfolio overview			14
Halogen portfolio overview			16
Off-road portfolio overview			21
<b>LED lamps</b>			
■ LEDDriving <sup>®</sup> HL <sup>1)</sup>	LED high and low beam lamps	P43t (H4), PX26d (H7), PGJ19-2 (H11), P22d (HB4)	24
■ LEDDriving <sup>®</sup> FL <sup>1)</sup>	LED fog lamps	PGJ19-1/-2/-3 (H8/H11/H16), PY20d (H10), PG20-7 (PSX24W)	26
■ LEDDriving <sup>®</sup> PREMIUM SL <sup>1)</sup> & LEDDriving <sup>®</sup> SL <sup>1)</sup> (exterior)	LED signal lamps	BA15s (P21W), BAY15d (P21/5W), BAU15s (PY21W), W2.5x16q (P27/7W), PG20-1 (P13W), PG18.5d-1 (PS19W), BA9s (T4W), W2.1x9.5d (W5W, WY5W, W16W), W3x16d (W21W), W3x16q (W21/5W)	28
■ LEDDriving <sup>®</sup> PREMIUM SL <sup>1)</sup> & LEDDriving <sup>®</sup> SL <sup>1)</sup> (interior)	LED interior lamps	SV8.5-8 (C5W), BA9s (T4W), W2.1x9.5d (W5W, WY5W, W16W)	30
■ LEDDriving <sup>®</sup> HL <sup>1)</sup> & PREMIUM SL <sup>1)</sup>	LED truck lamps	P43t (H4), PX26d (H7), PGJ19-2 (H11), P22d (HB4), W2.1x9.5d (W5W), BA9s (T4W)	32
<b>Xenon</b>			
OSRAM Trust Program	Verify original OSRAM xenon products	D1S, D1R, D2S, D2R, D3S, D3R, D4S, D4R, D8S	38
■ XENARC <sup>®</sup> NIGHT BREAKER <sup>®</sup> LASER	Brightest OSRAM xenon light	D1S, D2S, D3S, D4S	40
■ XENARC <sup>®</sup> COOL BLUE <sup>®</sup> INTENSE	Extra-blue xenon light	D1S, D1R, D2S, D2R, D3S, D4S	42
■ XENARC <sup>®</sup> ULTRA LIFE	Superior life and 10-year guarantee <sup>2)</sup>	D1S, D2S, D3S, D4S	44
■ XENARC <sup>®</sup> ORIGINAL	4-year guarantee <sup>3)</sup>	D1S, D1R, D2S, D2R, D3S, D3R, D4S, D4R, D5S, D8S	46
<b>Halogen car</b>			
■ NIGHT BREAKER <sup>®</sup> LASER	Brightest OSRAM halogen light	H1, H3, H4, H7, H8, H11, HB3, HB4	50
■ NIGHT BREAKER <sup>®</sup> SILVER	Excellent performance-lifetime ratio	H1, H4, H7, H11	52
■ COOL BLUE <sup>®</sup> INTENSE	Bluish-white light for xenon look	H1, H3, H4, H7, H8, H11, H15, H16, H27W/1, H27W/2, HB3, HB4, HIR2, W5W	54
■ DIADEM <sup>®</sup> CHROME   DIADEM <sup>®</sup>	Only amber or red during operation	PY21W, WY5W, PR21W, PR21/5W	56
■ ULTRA LIFE	Longer life and 4-year guarantee <sup>4)</sup>	H1, H4, H7, H11, C5W, H6W, HY21W, P21W, P21/5W, PY21W, R5W, R10W, W5W	58
■ ORIGINAL LINE 12 V	Original spare part	Complete product range	60
■ MINIBOX	Spare lamp kit		64
<b>Halogen truck</b>			
■ TRUCKSTAR <sup>®</sup> PRO	Brightest OSRAM truck light	H1, H3, H4, H7, H11, PY21W, P21W, P21/5W, W5W, R5W, R10W, T4W	68
■ ORIGINAL LINE 24 V	Original spare part for trucks	Complete product range	70
■ Spare lamp kit 24V			72

1) These products do not have ECE approval. This means they must not be used on public roads in any exterior application. Use on public roads leads to cancellation of operating license and loss of insurance coverage. Several countries do not allow sale and use of these

Category	Highlight Feature	ECE/Range	Page
<b>Halogen motorcycle</b>			
■ NIGHT RACER® 110	Brightest OSRAM motorcycle light	H4, H7, H8, H11	76
■ NIGHT RACER® 90	More light and vibration-resistance <sup>5)</sup>	HS1	76
■ NIGHT RACER® 50	Excellent performance-lifetime ratio	H4, H7, H11, HS1	78
■ X-RACER®	Bluish-white light for xenon look	H4, H7, H8, H11, HS1, S2	80
■ ORIGINAL	Original spare part	H4, H7, HS1, S1, S2, R2	80
<b>Off-road</b>			
■ SUPER BRIGHT PREMIUM <sup>1)</sup> ■ SUPER BRIGHT <sup>1)</sup>	Extra power for off-road use	P14.5s (H1), PK22s (H3), P43t (H4), PX26d (H7), P20d (HB3/HB3A), PX14.5s, PKY22s, PU43t, P45t (R2)	84
■ XENARC® COOL BLUE® BOOST <sup>1)</sup>	Hyper blue light for off-road use	PK32d-2 (D1S), P32d-2 (D2S), PK32d-5 (D3S), P32d-5 (D4S)	86
■ COOL BLUE® BOOST <sup>1)</sup>		P14.5s (H1), P43t (H4), PX26d (H7), PGJ19-5 (H9), PGJ19-2 (H11), P20d (HB3/HB3A), P22d (HB4/HB4A)	
<b>LED fixtures</b>			
■ LEDriving® headlights (VW Golf VII)	Easy and legal full LED redesign	LEDHL103-GTI/-CM/-BK, LEDHL104-GTI/-CM/-BK	90
■ LEDriving® XENARC® headlights (Ford Focus 3, VW Golf VI)	Easy and legal LED and xenon redesign	LEDHL105, LEDHL102-GTI/-CM/-BK	92
■ LEDriving® dynamic mirror indicator	Innovative lighting technology	LEDDMI 5G0 WT S/LEDDMI 5G0 BK S LEDDMI 3G0 WT S	94
■ LEDriving® driving lights	Dedicated application options	LEDDL102-SP/103/104/105/106/107	96
■ LEDriving® working lights	Professional application options	LEDDL101/102-WD	98
■ LEDriving® daytime running lights	Increase visibility during the day	LEDDRL102, LEDDRL301 CL15	100
■ LEDriving® fog lights	Improving both visibility and style	LEDFOG102, LEDFOG103-SR/-BL LEDFOG201	102
<b>LED styling lights</b>			
■ LEDambient® CONNECT <sup>1)</sup>	Individual, app-controlled LED ambience	LEDEXT101, LEDINT103, LEDEXT102-03/-04/-10, LEDINT102/104	108
■ LEDambient®	Individual, remote-controlled LED ambience	LEDINT201/201-SEC/202/203	110
<b>LED accessories</b>			
■ LEDinspect® PRO	LED inspection lights for professional usage	LEDIL103/104/105/106/107/108	114
■ LEDinspect®	LED inspection lights for private usage	LEDIL201/202/203/204/205/205-PK 205-BKPK/206/207/209	118
■ LEDguardian® <sup>1)</sup>	LED warning lights for emergency	LEDL101/302	122
■ ONYX COPILOT®	Flexible LED reading light	ONYX-USB, ONYX M-7, ONYX L-7	124
<b>Tools</b>			
Shelf Rack   MINIWATT® assortment box   Automotive lamp cabinet			128
POS product presentation and demonstration			130
Measurements			134
Bases			140
Index			142
Summary of types and applications			158
Order information			168

■ = INNOVATION ■ = PERFORMANCE ■ = DESIGN ■ = COMFORT ■ = ORIGINAL

products. Please contact your local distributor for information on the availability in your country. | 2) With online product registration. Refer to [www.osram.com/am-guarantee](http://www.osram.com/am-guarantee) for precise conditions and registration. | 3) Refer to [www.osram.com/am-guarantee](http://www.osram.com/am-guarantee) for precise conditions. | 4) 4th year with online product registration. Refer to [www.osram.com/am-guarantee](http://www.osram.com/am-guarantee) for precise conditions and registration. 5) Compared to minimum ECE R112 requirements | 6) Please note: This catalogue contains an international portfolio. Several countries do not allow sale and use of non-ECE approved products. Please contact your local distributor for information on the availability in your country.

All OSRAM 12 V and 24 V halogen automotive lamps are UV-reduced, can replace existing lamps and meet the relevant standards, e.g. ECE R37 (with the exception of OFF-ROAD lamps)

# 200 best reasons for OSRAM – the number 1 worldwide

On average, around 200 lamps are fitted in every car – that’s 200 times top quality from OSRAM, the global leader in lighting solutions on and in your vehicle. OSRAM is a leader in innovation and technology, and sells the highest volume of lamps in the fast growing OEM market for cars, as well as in the rapidly expanding market for replacement lamps.

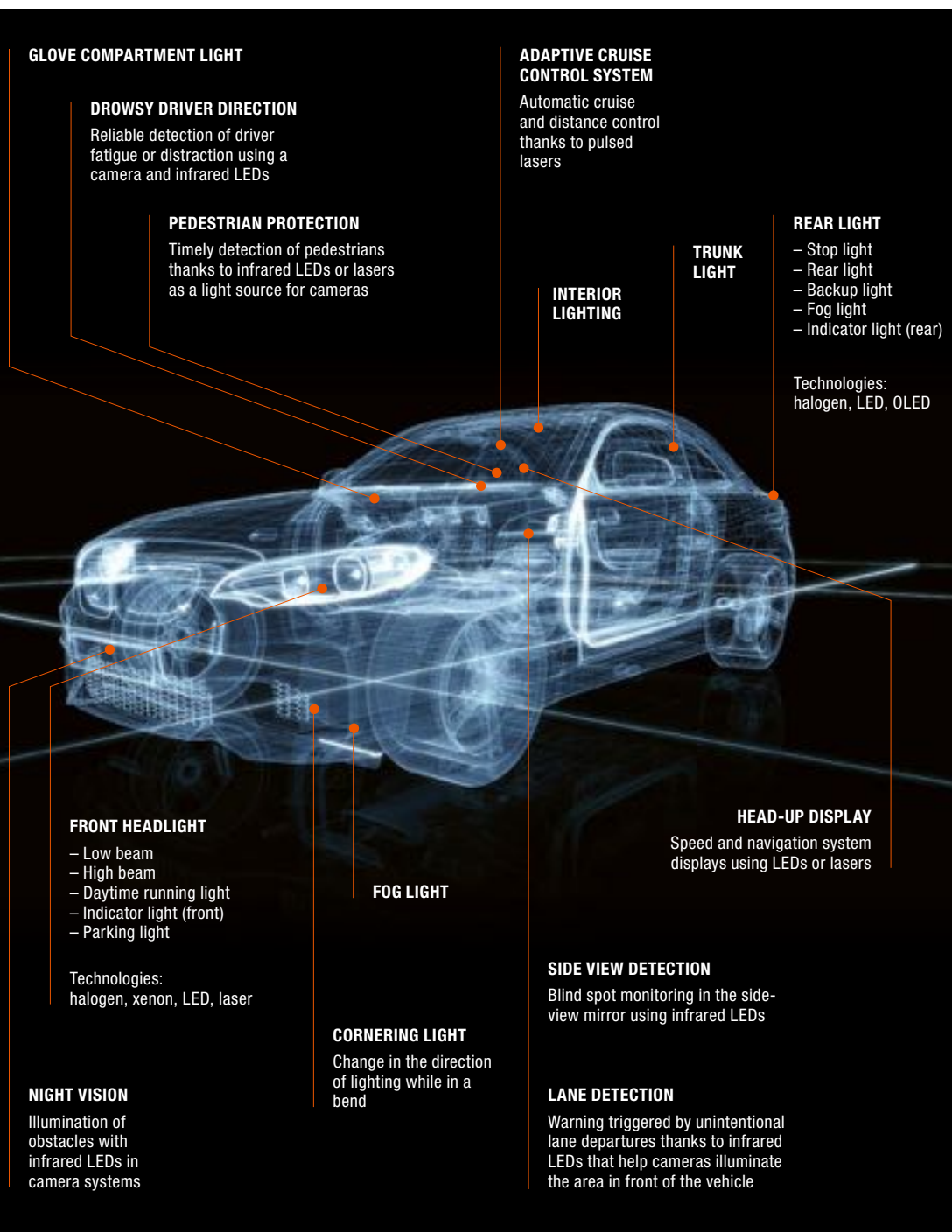

## From the headlights to the rear lights

No matter where you look in a car, you will find lights. Their possible applications are immense. Several examples show the many different ways that OSRAM products manufactured across the world are used.

Here you can see the wide range of possible applications of lights in cars.

Greater Performance, enhanced safety and a modern design are the trends for modern vehicle lighting – and also the focus of our research.

# OSRAM color code packaging – Go for your perfect match

Packaging for OSRAM vehicle lamps, luminaires and LED innovations perfectly cover with its clear, comprehensible color coding system all demands and types of customer.



## Color coding at a glance

- INNOVATION** Latest LED technology: Lamps and fixtures for a modern look.
- PERFORMANCE** More brightness: Luminous intensity and maximum light output.
- DESIGN** Stylish light: Modern look due to bluish-white light.
- COMFORT** Longer lifetime: Drive more, exchange less.
- ORIGINAL** Original spare part: Lamps with proven OEM quality.

## Packaging information at a glance

The OSRAM packaging design has a twofold effect: eye-catching from a distance – and clear, persuasive information when seen up close, according to the motto “less is more”.

**Type and order reference.** (Points to the top section of the package)

**Quality indicator – original spare part in OEM quality.** (Points to the OE logo)

**Clear visualization of product and corresponding application. Always replace in pairs.** (Points to the lamp image and car illustration)

**Regionally required text and barcode for optimum consumer information. Changes from region to region due to different regional requirements.** (Points to the bottom text and barcode)

**Application notes, safety information and mandatory pictograms.** (Points to the bottom section of the package)

The added value of the product compared to the standard product is explained in pictograms – comparison of luminous intensity, beam length, light color and service life. Within the LED portfolio, that space is used for application notes, technical information or installation advice.

**i** Get in touch with us and learn more about the OSRAM packaging concept: [www.osram.com/the-perfect-match](http://www.osram.com/the-perfect-match)



## Light is a safety aspect

**When it comes to car lights, most drivers follow the principle “As long as it shines, I do not have to do anything.” This means they just change their lamps if they break or burn out. Until they are able to replace the lamps, they drive with just one headlight. This results in an increased risk security due to low light that drivers often underestimate. Replacing headlight lamps on time and in pairs can counteract this risk.**

Many people find night driving exhausting. The reasons are as diverse as the customers. If a lamp burns out, this means less lighting for the driver on the road and thus a reduced field of vision – a safety risk. The driver can prevent this by proactively replacing the lamps.

### **Two is better than one**

Headlamps produce less light with age. It is therefore important to regularly check the functionality of the lamp and replace it if necessary. In general, an annual review and an exchange every two to three years is recommended. If only one lamp is replaced, it differs from the second, now older one because the new one produces a higher light output. This can lead to an unbalanced spotlight, again a potential safety risk. Replacing lamps in pairs ensures optimal light output and visibility.

### **Value-added products recommended**

There are great differences in quality among car lamps. Preventive replacement provides an opportunity to think about how to choose a product. After all, replacement lamps are not always the same, high quality lamps that one would get in a new car. In general, a high-quality value-added product is recommended. The choice depends on how much value the customer attaches to the design, light output or lifetime of the product. OSRAM's broad portfolio offers each customer choices for an adequate lamp based on their respective needs.

There are alternatives for headlamps, ranging from the inexpensive “original” standard product to high-performance lamps with much better light. This category includes the upgrade models of NIGHT BREAKER® family. The performance lamps produce a longer and brighter light beam compared with standard products. This allows drivers to identify dangerous situations sooner and more accurately, and gain valuable reaction time. OSRAM's extensive vehicle lamp portfolio offers garages and their customers high-quality, high-performance products that do not leave drivers in the dark, even when driving at night.

**Your vehicle deserves OSRAM – the No. 1 in automotive lighting**  
For more information: [www.osram.com/automotive](http://www.osram.com/automotive)

## Two shines better than one: Always change lamps in pairs

Tires, brakes, shock absorbers or wiper blades: Experienced drivers know that important parts of the car should always be changed in pairs. This also applies to lamps.

### **New lamps have a higher light output and different radiation characteristics than previously used lamps.**

Replacing only the defective lamp can result in an unbalanced spotlight beam – a potential safety risk.

- From the driver's perspective, the road ahead is not properly illuminated.
- From the oncoming drivers' perspective, the car is more difficult to see – and it could, for example, also be confused with a motorcycle.

### **And once a lamp is broken, it usually does not take long until the second fails as well.**

- Changing in pairs reduces the risk that the other lamp will fail while driving.
- On top of that, you save time by not having to go to the garage or store twice, as well as the compounded work.

## Two more obvious tips for changing lamps

### **Change before the final failure**

Lamp performance and power decreases over time. At the end of their life, lamps produce less light, which reduces drivers' field of view and visibility at night – and therefore safety.

### **Cut to the optimal solution**

More light, whiter light, longer life, attractive design: It is better to choose lamps that match your own lighting requirements and preferably from a brand-name manufacturer and technological leader, such as OSRAM.



# Portfolio overview LED



>> Page 24

**INNOVATION / LED RETROFITS**

**LEDDriving® HL<sup>1)</sup>**  
LED high and low beam



**Light in a new dimension**

The OSRAM LED high and low beam lamps represent the most convenient solution in order to upgrade your existing headlights – providing a stylish cool white look with 6,000 K as well as improved visibility for everything that lies ahead of you.

**Range**

P43t (H4), PX26d (H7), PGJ19-2 (H11), P22d (HB4)



>> Page 26

**INNOVATION / LED RETROFITS**

**LEDDriving® FL<sup>1)</sup>**  
LED fog lamp



**Light is maximum visibility**

The new LEDDriving® FL as socket solution provides an upgrade for conventional fog lamps with SSL technology and a color temperature of 6,000 K. These LED fog lamps matches perfectly existing LED daytime running lights and xenon low- and high-beam systems.

**Range**

PGJ19 (H8/H11/H16), PY20d (H10), PG20-7 (PSX24W)



>> Page 28

**INNOVATION / LED RETROFITS**

**LEDDriving® SL & PREMIUM SL<sup>1)</sup>**  
LED signal lamps



**Wide range of different bases**

Perfect for a multitude of applications, OSRAM LED signal lamps LEDDriving® SL & PREMIUM SL illuminate vehicle exteriors with high color temperatures of up to 6,000 K.

**Range**

BA15s (P21W), BAY15d (P21/5W), BAU15s (PY21W), W2.5x16q (P27/7W), PG20-1 (P13W), PG18.5d-1 (PS19W), BA9s (T4W), W2.1x9.5d (W5W, WY5W, W16W), W3x16d (W21W), W3x16q (W21/5W)

1) These products do not have ECE approval. This means they must not be used on public roads in any exterior application. Use on public roads leads to cancellation of operating license and loss of insurance coverage. Several countries do not allow sale and use of these products. Please contact your local distributor for information on the availability in your country.





>> Page 30

#### INNOVATION / LED RETROFITS

LEDriving® SL & PREMIUM SL<sup>1)</sup>  
LED interior lamps

INTERIOR  
APPLICATION

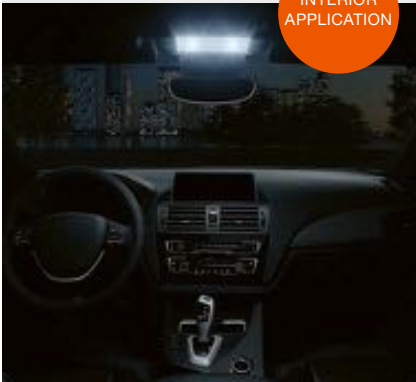

#### Wide range of different light colors

From dome light to foot area, from glove box to trunk, simply replace old lamps with OSRAM's plug-and-play solution for LED signal lamps as LEDriving® SL and PREMIUM SL. Also available in PREMIUM for trucks (24 V).

#### Range

SV8.5-8 (C5W), BA9s (T4W),  
W2.1x9.5d (W5W, WY5W, W16W)



>> Page 90/92

#### INNOVATION / LED FIXTURES

LEDriving® headlight<sup>2)</sup>  
LEDriving® XENARC® headlight<sup>3)</sup>



#### Full LED redesign made easy – and legal

LEDriving® headlights and LEDriving® XENARC® headlights bring a distinctive look to VW Golf VI, VII and Ford Focus 3 cars, making it possible to upgrade from halogen or xenon headlights with LED daytime running lights and LED indicator lamps.

#### Range

VW Golf VI: CHROME, BLACK, GTI  
Ford Focus 3: BLACK  
VW Golf VII: CHROME, BLACK, GTI



>> Page 94

#### INNOVATION / LED FIXTURES

LEDriving® dynamic mirror  
indicator



#### Unique design meets innovative lighting technology

The powerful LEDs in the new dynamic side mirror indicators provide up to 200 percent more light than the minimum ECE R6 requirement. As a result, they offer an outstanding performance in their class. The high contrast of the intense yellow LED light makes the indicators easier for oncoming drivers to see both at night and during the day.

#### Range

VW Golf VII, VW Passat B8, BMW F20 and compatible with many more models

2) Only suitable for VW Golf VII car models with OEM halogen or OEM xenon-headlights with halogen daytime running light

3) Only suitable for VW Golf VI and Ford Focus 3 cars with OEM halogen headlight



>> Page 96

INNOVATION / LED FIXTURES

**LEDriving® driving lights<sup>1)</sup>**



**Dedicated application options**

OSRAM's LED driving lights offer the most sophisticated LED technology and electrical design on the market. Products are available in three categories (functional, multifunctional and slim) offering a variety of performances, shapes and beam patterns with various illumination profiles like spot and combo. Products are available for 12 and 24 voltage vehicles.

**Range**

LIGHTBAR MX140-SP<sup>1)</sup>, LIGHTBAR FX250-SP<sup>1)</sup>/-CB<sup>1)</sup>, LIGHTBAR FX500-SP<sup>1)</sup>/-CB<sup>1)</sup>/-CB SM<sup>1)</sup>, LIGHTBAR SX180-SP, LIGHTBAR SX300-SP, LIGHTBAR SX500-SP



>> Page 98

INNOVATION / LED FIXTURES

**LEDriving® working lights**



**Professional application options**

OSRAM's LED working lights offer the most sophisticated LED technology and electrical design on the market. The products offer a variety of performances, shapes and beam patterns with various illumination profiles like spot and wide. Products are available for 12 and 24 voltage vehicles.

**Range**

CUBE MX85-SP/-WD, LIGHTBAR MX140-WD<sup>1)</sup>



>> Page 100

INNOVATION / LED FIXTURES

**LEDriving® daytime running lights**



**Stylish highlights for state-of-the-art headlights**

Innovative, easy-to-install light-guide and pixel solution with high-quality LED technology for low energy consumption and long lifetime: LEDriving® daytime running lights are the right choice for drivers who want to increase visibility during the day and with an eye for design.

**Range**

LG, PX-5

1) Driving lights must be installed in pairs for 12/24 V-vehicles



>> Page 102

INNOVATION / LED FIXTURES

### LEDriving® fog lights



#### Better sight, better looks

The models in OSRAM's LEDDriving® fog lights series make the switch to new LED fog lights easier than ever: Coming with a range of additional mounting brackets, the fog lights can be configured to suit nearly all types of vehicles.

#### Range

FOG, FOG PL, FOG F1



>> Page 108

INNOVATION / LED STYLING LIGHTS

### LEDAmbient® CONNECT



#### Light is pulsating

The LEDAmbient® CONNECT family offers you to individualize your vehicle's look. Simple to install and run, these innovative LED products use Bluetooth® technology. Once paired to the free LEDAmbient® CONNECT app, you can synchronize your music with up to 10 LEDAmbient® CONNECT systems to pulse to the same beat.

#### Range

TUNING LIGHTS BASE KIT<sup>2)</sup>,  
TUNING LIGHTS EXTENSION KIT<sup>2)</sup>,  
PULSE CONNECT<sup>3)</sup>, HYBRID  
CONNECT<sup>2)3)</sup>



>> Page 110

INNOVATION / LED STYLING LIGHTS

### LEDAmbient®



#### Interior ambient lighting

The LEDAmbient® interior lights enable you to illuminate every single corner of your car. The high brightness of the products combined with the modern color temperatures puts your car into a new light. The LED strips are rapidly and easily mounted.

#### Range

TUNING LIGHTS BASE KIT<sup>2)</sup>,  
TUNING LIGHTS EXTENSION KIT<sup>2)</sup>,  
INTERIOR STRIP Kit<sup>2)</sup>

2) These products do not have ECE approval. This means they must not be used on public roads in any exterior application. Use on public roads leads to cancellation of operating license and loss of insurance coverage. Several countries do not allow sale and use of these products. Please contact your local distributor for information on the availability in your country.

3) Do not use while driving

# Portfolio overview LED



>> Page 114

INNOVATION / LED INSPECTION LIGHTS

**LEDinspect® PRO**



**Essential to your garage**

The LEDinspect® PRO inspection lights are especially developed for the complex maintenance and repairs you tackle every day in your garage. Each unique lamp design reflects an understanding of professional applications and supplies light precisely where you need it.

**Range**

SLIMLINE 500, POCKET 280, PENLIGHT 150 UV-A, PENLIGHT 150, BONNET 1400, SLIMLINE 280



>> Page 118

INNOVATION / LED INSPECTION LIGHTS

**LEDinspect®**



**Essential to your DIY toolbox**

The rechargeable or ordinary battery-operated LED inspection lights are ideal for use at home. Equipped with durable, high-power LEDs, the luminaires provide optimum illumination for even the tightest spaces and difficult-to-access locations.

**Range**

HEADLAMP 300, PROFESSIONAL 150, SLIMLINE 250, FLASHLIGHT 15, POCKET 160, PENLIGHT 80, MINI 125, FOLDABLE 80



>> Page 122

INNOVATION / LED WARNING LIGHTS

LEDguardian®



**Prepared for serious situations**

OSRAM LEDguardian® warning lights are the ideal LED accessory for drivers who want to be equipped for any situation.

**Range**

SAVER LIGHT PLUS<sup>1)</sup>, ROAD FLARE<sup>1)</sup>



>> Page 124

INNOVATION / LED READING LIGHTS

ONYX COPILOT®



**Good light for a good ride**

ONYX COPILOT® is a flexible LED reading light with pleasantly warm, glare-free light. With its high flexibility, the ONYX COPILOT® light has a wide range of options for illuminating specific areas of the vehicle interior.

**Range**

ONYX-USB, ONYX M-7, ONYX L-7

1) Not approved as warning light according to German Road Traffic Licensing Regulations (StVZO). Not for sale in Germany.

# Portfolio overview xenon



>> Page 40

## PERFORMANCE

XENARC® NIGHT BREAKER® LASER

**UP TO +200% BRIGHTNESS<sup>1)</sup>**

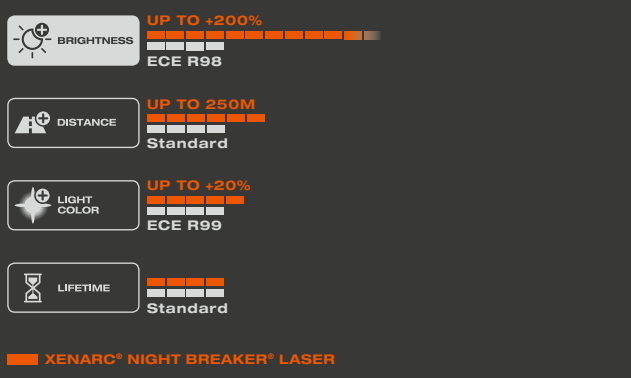

### ECE/Range

D1S, D2S, D3S, D4S



>> Page 42

## DESIGN

XENARC® COOL BLUE® INTENSE

**XENON EXTRA BLUE**

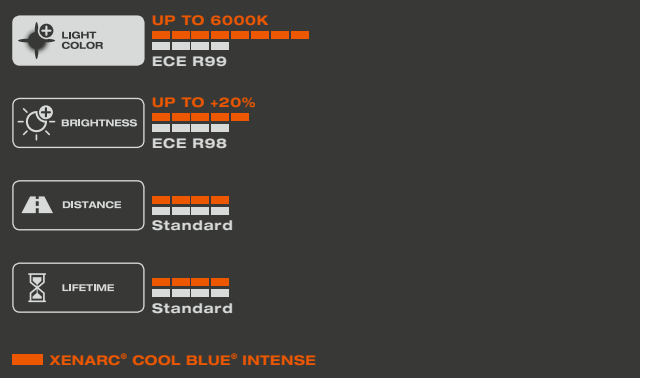

### ECE/Range

D1S, D1R, D2S, D2R, D3S, D4S

1) Compared to minimum ECE R98 requirements



>> Page 44

COMFORT

XENARC® ULTRA LIFE

**10-YEAR OSRAM  
GUARANTEE<sup>2)</sup>**

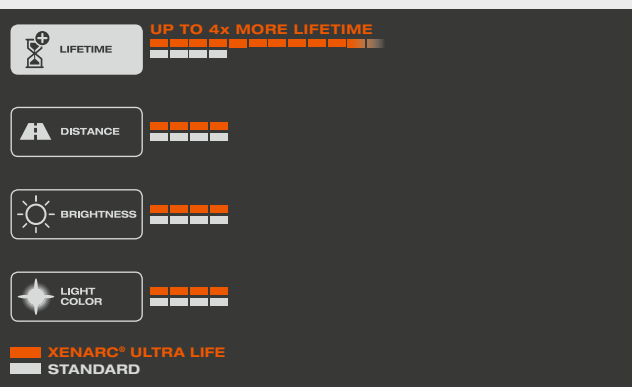

**ECE/Range**

D1S, D2S, D3S, D4S



>> Page 46

ORIGINAL

XENARC® ORIGINAL

**ORIGINAL SPARE PART**

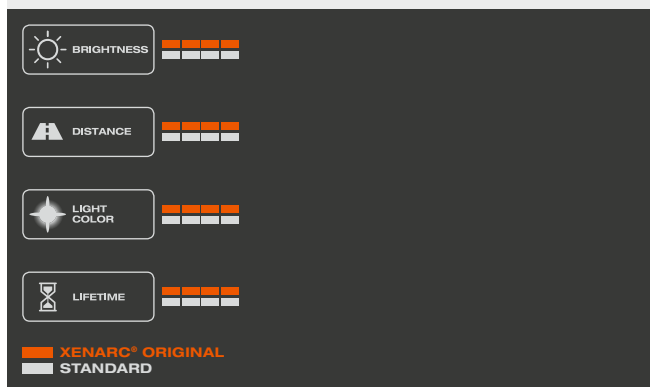

**ECE/Range**

D1S, D1R, D2S, D2R, D3S, D3R, D4S, D4R, D5S, D8S

2) With online product registration. Refer to [www.osram.com/am-guarantee](http://www.osram.com/am-guarantee) for precise conditions and registration

# Portfolio overview halogen car



>> Page 50

**PERFORMANCE**

**NIGHT BREAKER® LASER**

**UP TO +150%  
BRIGHTNESS<sup>1)</sup>**

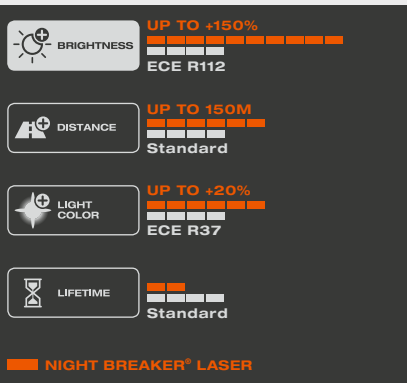

**ECE/Range**

H1, H3, H4, H7, H8, H11, HB3, HB4



>> Page 52

**PERFORMANCE**

**NIGHT BREAKER® SILVER**

**UP TO +100%  
BRIGHTNESS<sup>1)</sup>**

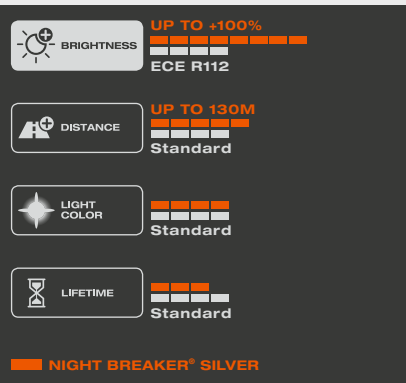

**ECE/Range**

H1, H4, H7, H11



>> Page 54

**DESIGN**

**COOL BLUE® INTENSE**

**XENON LOOK**

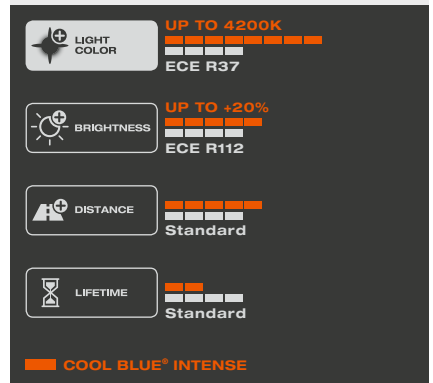

**ECE/Range**

H1, H3, H4, H7, H8, H11, H15, H16, H27W/1, H27W/2, HB3, HB4, HIR2, W5W

1) Compared to minimum ECE R112 requirements





>> Page 56

DESIGN

DIADEM® CHROME / DIADEM®  
**AMBER / RED  
WHEN ON**

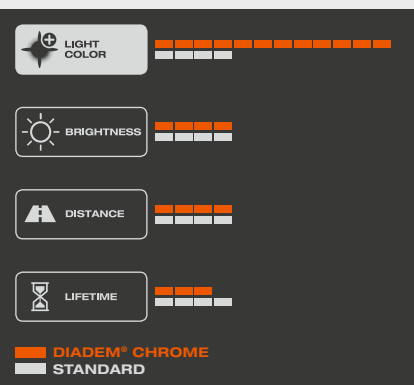

**ECE/Range**  
WY5W, PY21W, PR21W, PR21/5W



>> Page 58

COMFORT

ULTRA LIFE  
**4-YEAR OSRAM  
GUARANTEE<sup>2)</sup>**

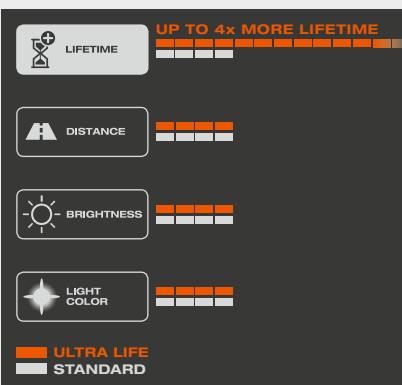

**ECE/Range**  
H1, H4, H7, H11, P21W, PY21W,  
P21/5W, W5W, R5W, R10W, C5W,  
H6W, HY21W



>> Page 60

ORIGINAL

ORIGINAL  
**ORIGINAL  
SPARE PART**

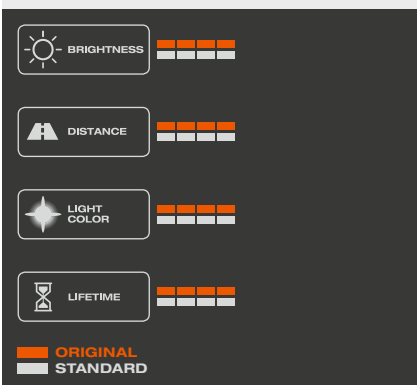

**ECE/Range**  
Complete Product Range

2) 4th year with online product registration. Refer to [www.osram.com/am-guarantee](http://www.osram.com/am-guarantee) for precise conditions and registration

# Portfolio overview halogen truck



>> Page 68

**PERFORMANCE**

**TRUCKSTAR® PRO**  
**UP TO +100% BRIGHTNESS<sup>1)</sup>**

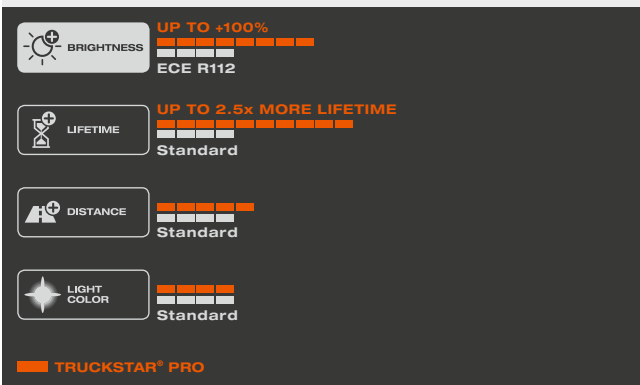

**ECE/Range**  
 H1, H3, H4, H7, H11, PY21W, P21W, P21/5W, W5W, R5W, R10W, T4W



>> Page 70

**ORIGINAL**

**ORIGINAL**  
**ORIGINAL SPARE PART**

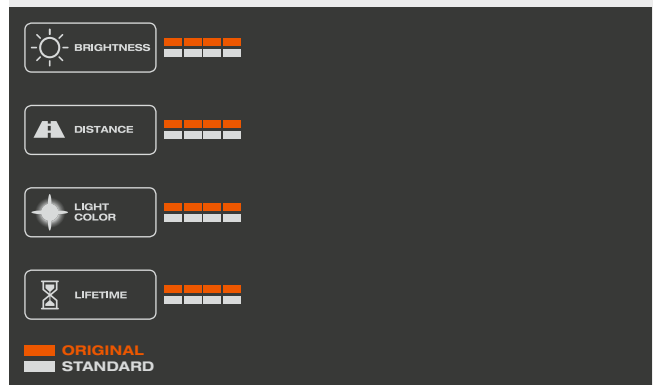

**ECE/Range**  
 Complete Product Range

# Portfolio overview halogen motorcycle



>> Page 76

>> Page 76

>> Page 78

**PERFORMANCE**

**NIGHT RACER® 110**

**UP TO +110%  
BRIGHTNESS<sup>1)</sup>**

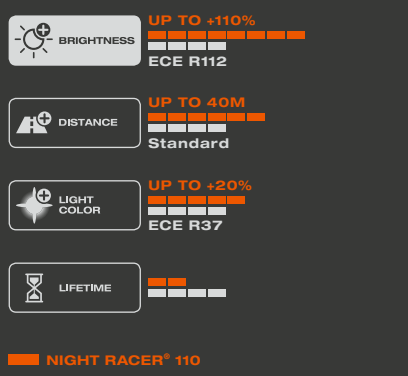

**ECE/Range**  
H4, H7, H8, H11

**PERFORMANCE**

**NIGHT RACER® 90**

**UP TO +90%  
BRIGHTNESS<sup>1)</sup>**

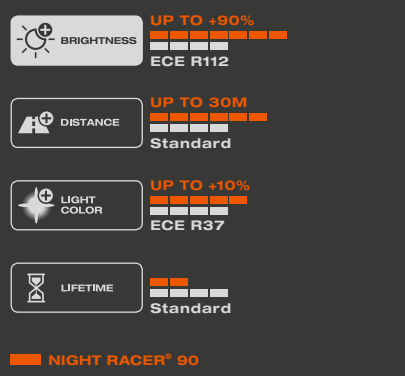

**ECE/Range**  
HS1

**PERFORMANCE**

**NIGHT RACER® 50**

**UP TO +50%  
BRIGHTNESS<sup>1)</sup>**

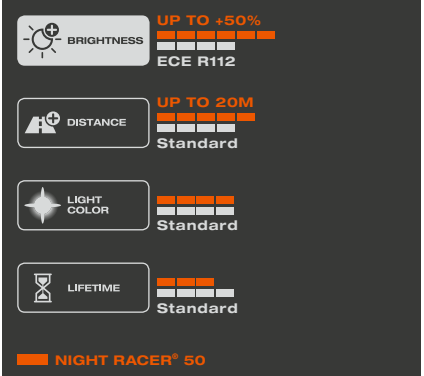

**ECE/Range**  
H4, H7, H11, HS1

1) Compared to minimum ECE R112 requirements



>> Page 80

>> Page 80

DESIGN

ORIGINAL

X-RACER®  
**XENON LOOK**

ORIGINAL  
**ORIGINAL SPARE PART**

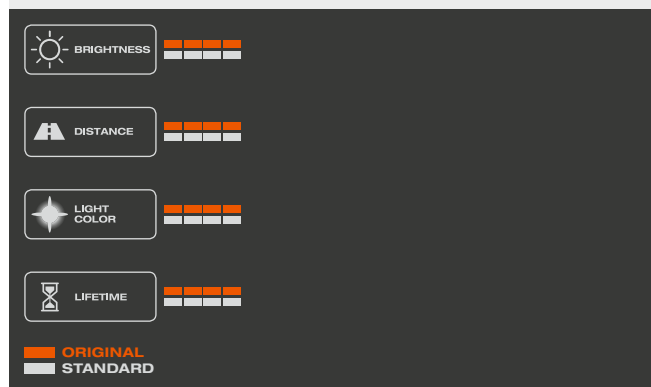

**ECE/Range**  
H4, H7, H8, H11, HS1, S2

**ECE/Range**  
H4, H7, S1, S2, R2, HS1

1) Compared to minimum ECE R112 requirements

# Portfolio overview off-road



>> Page 84

## PERFORMANCE

SUPER BRIGHT/  
SUPER BRIGHT PREMIUM<sup>2)</sup>

**EXTRA POWER**

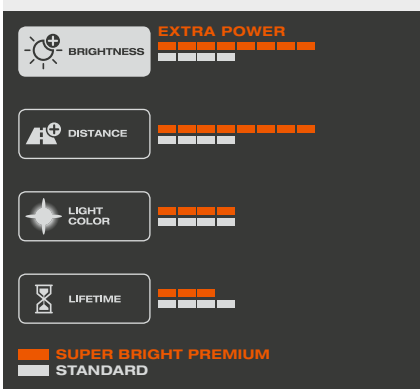

### ECE/Range

P14.5s (H1), PK22s (H3), P43t (H4),  
PX26d (H7), P20d (HB3), P22d (HB4)  
PX14.5s, PKY22s, PU43t, P45t (R2)



>> Page 86

## DESIGN

XENARC® COOL BLUE® BOOST<sup>2)</sup>

**XENON HYPER  
BLUE**

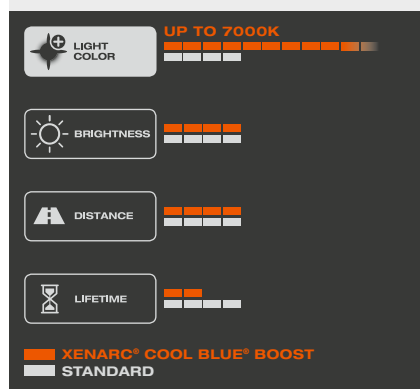

### ECE/Range

PK32d-2 (D1S), P32d-2 (D2S),  
PK32d-5 (D3S), P32d-5 (D4S)



>> Page 86

## DESIGN

COOL BLUE® BOOST<sup>2)</sup>

**HYPER BLUE**

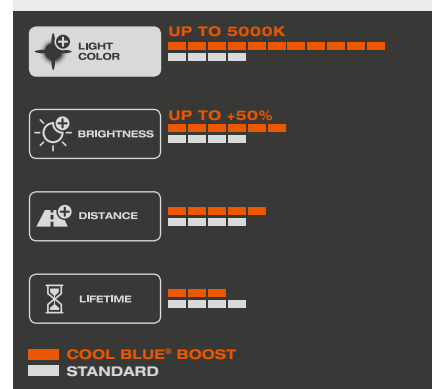

### ECE/Range

P14.5s (H1), P43t (H4), PX26d (H7),  
PGJ19-5 (H9), PGJ19-2 (H11), P20d  
(HB3/HB3A), P22d (HB4/HB4A)

<sup>2)</sup> These products do not have ECE approval. This means they must not be used on public roads in any exterior application. Use on public roads leads to cancellation of operating license and loss of insurance coverage. Several countries do not allow sale and use of these products. Please contact your local distributor for information on the availability in your country.



# LEDDriving<sup>®</sup> replacement lamps

OSRAM provides a wide range of LED replacement lamps for various applications. The LEDDriving<sup>®</sup> RETROFIT portfolio includes LED high and low beam lamps, fog lamps, signal as well as interior lamps with superior brightness and color temperatures of up to 6,000 K.



# OSRAM LEDriving® HL

## LED high and low beam in a new dimension

With a color temperature of 6,000 K and a very compact design, the OSRAM LEDriving® HL retrofits provide an easy solution to upgrade car headlights with cool white LED light – providing a stylish look as well as superior brightness. The LED high and low beam lamps by OSRAM as replacement of conventional H4, H7, HB4 and H11 lamps. With the latest LED technology and very compact design, these new lamps allow a high compatibility and an easy installation for an even wider range of car models. LEDriving® HL lamps are 12 V and 24 V compatible. The pair of lamps comes with a 5-year OSRAM guarantee<sup>1)</sup> and with a long service life.



### Features<sup>1)</sup>

- Cool White color temperature of 6,000 K
- Superior brightness
- Very compact LED replacement for conventional H4, H7, HB4 and H11 high and low beam lamps
- Premium OSRAM quality made in Italy
- Long lifetime of up to 5,000 h
- Integrated electronics, no external driver

### Benefits<sup>1)</sup>

- Better visibility thanks to daylight effect
- More light allows to see farther and therefore react sooner. Signs, obstacles and hazards can be recognized sooner
- Reduced glaring thanks to an optimized light distribution
- 5-year guarantee<sup>2)</sup>
- More durability due to LED technology
- Simple plug & play installation and improved compatibility



**Check the compatibility of your car!**  
[www.osram.com/ledcheck](http://www.osram.com/ledcheck)





**OSRAM LEDDriving® HL product range**



Product Reference		Product Number	V	W	K	COLOR			No.
9726CW	P43t (H4)	4052899 <b>605121</b>	12/24	14	6000	Cool White	2	4	1 <sup>P.134</sup>
67210CW	PX26d (H7)	4052899 <b>605084</b>	12/24	14	6000	Cool White	2	4	2 <sup>P.134</sup>
67211CW <sup>3)</sup>	PGJ19-2 (H11)	4052899 <b>605107</b>	12/24	14	6000	Cool White	2	4	3 <sup>P.134</sup>
9736CW	P22d (HB4)	4052899 <b>605145</b>	12/24	14	6000	Cool White	2	4	4 <sup>P.134</sup>



Conventional lamp – Halogen high beam

OSRAM LEDDriving® HL – LED high beam



Conventional lamp – Halogen low beam

OSRAM LEDDriving® HL – LED low beam

1) These products do not have ECE approval. This means they must not be used on public roads in any exterior application. Use on public roads leads to cancellation of operating license and loss of insurance coverage. Several countries do not allow sale and use of these products. Please contact your local distributor for information on the availability in your country.

2) Refer to [www.osram.com/am-guarantee](http://www.osram.com/am-guarantee) for precise conditions

3) LEDDriving® CANBUS CONTROL UNIT avoids error messages on the board computer when using LED lamps within 50 W (LEDCBCTRL103 P.34) applications



## OSRAM LEDriving<sup>®</sup> FL

### LED fog lamps for maximum visibility

The latest generation of OSRAM LED fog lamps provides an even more convenient solution in order to replace and upgrade existing halogen fog lamps: With its ultra compact dimensions, the OSRAM LEDriving<sup>®</sup> FL provides optimized compatibility as well as easy plug & play installation. Upgrading with state-of-the-art LED technology and a color temperature of 6,000 K for a stylish cool white look as well as improved visibility. These LED products offer a perfect color match with xenon and LED headlights and are for conventional H8/H11/H16 or H10 fog lamps. A pair of new LEDriving<sup>®</sup> FL lamps, comes with a 3-year OSRAM guarantee<sup>1)</sup> as well as with a long service life by less energy consumption.

#### Features<sup>1)</sup>

- Cool White color temperature of 6,000 K
- Superior brightness
- Ultra compact LED replacement for conventional H8/H11/H16 and H10 fog lamps as socket solution
- Premium OSRAM quality

#### Benefits<sup>1)</sup>

- Better visibility in foggy situations with a perfect color match for xenon and LED headlights. Signs, obstacles and hazards can be recognized sooner.
- More light allows to see farther and therefore react sooner with reduced glaring thanks to an optimized light distribution
- Easy installation with optimized compatibility
- 3-year guarantee<sup>2)</sup>



**OSRAM LEDDriving® FL product range**



Product Reference		Product Number	V	W	K	COLOR			No.
67219CW	PGJ19 (H8/H11/H16) <sup>3)</sup>	4052899 <b>605046</b>	12	13	6000	Cool White	2	4	6 <sup>P.134</sup>
9745CW	PY20d (H10)	4052899 <b>605060</b>	12	13	6000	Cool White	2	4	5 <sup>P.134</sup>
2604CW	PG20-7 (PSX24W)	4062172 <b>058360</b>	12	6.7	6000	Cool White	2	4	7 <sup>P.134</sup>



Conventional lamp –  
Halogen fog light

OSRAM LEDDriving® FL –  
LED fog light

- 1) These products do not have ECE approval. This means they must not be used on public roads in any exterior application. Use on public roads leads to cancellation of operating license and loss of insurance coverage. Several countries do not allow sale and use of these products. Please contact your local distributor for information on the availability in your country.
- 2) Refer to [www.osram.com/am-guarantee](http://www.osram.com/am-guarantee) for precise conditions
- 3) LEDDriving® CANBUS CONTROL UNIT avoids error messages on the board computer when using LED lamps within 50 W (LEDCBCTRL103 P.34) applications

# OSRAM LEDriving® SL

## Wide range of signal lamps with different bases

Perfect for a multitude of applications, OSRAM LEDriving® PREMIUM SL and LEDriving® SL illuminate vehicle exteriors with high color temperatures of up to 6,000 K. Thanks to their homogeneous light distribution, illumination is non-selective. OSRAM LED retrofits come with easy plug-and-play replacement, long life spans, low energy consumption – and 100% more style.



### Features of LEDriving® PREMIUM SL<sup>1)2)</sup>

- High color temperatures of up to 6,000 K
- Superior brightness
- Replaces conventional signal lamps for exterior application
- Premium OSRAM quality
- Long lifetime of up to 5,000 h, shockproof and vibration-proof with up to 80% less energy consumption<sup>3)</sup>



### Benefits of LEDriving® PREMIUM SL<sup>1)2)</sup>

- Wide range of different light colors for a variety of customization options
- Faster signals provide more reaction time for drivers behind you
- Smart electronics for easy installation
- 6-year guarantee<sup>4)</sup>
- More durability and very energy-efficient



### Features of LEDriving® SL<sup>1)2)</sup>

- High color temperatures of up to 6,000 K
- High brightness
- Replaces conventional signal lamps for exterior application
- OSRAM quality
- Long lifetime of up to 2,500 h with low energy consumption



### Benefits of LEDriving® SL<sup>1)2)</sup>

- Multiple light colors for a variety of customization options
- Non-selective illumination thanks to homogeneous light distribution
- Simple installation
- 4-year guarantee<sup>4)</sup>
- Durable and energy-efficient

1) These products do not have ECE approval. This means they must not be used on public roads in any exterior application. Use on public roads leads to cancellation of operating license and loss of insurance coverage. Several countries do not allow sale and use of these products. Please contact your local distributor for information on the availability in your country.

2) LEDriving® CANBUS CONTROL UNIT avoids error messages on the board computer when using LED lamps within 5 W (LEDCBCTRL101 P.34) or 21 W (LEDCBCTRL102 P.34) applications

3) Compared with conventional lamps | 4) Refer to [www.osram.com/am-guarantee](http://www.osram.com/am-guarantee) for precise conditions

**OSRAM LEDriving® SL and LEDriving® PREMIUM SL – EXTERIOR<sup>1)</sup> product range**



Product Reference		Product Number	V	W		K				
-------------------	--	----------------	---	---	--	---	--	--	--	--

**LEDriving® PREMIUM SL**

1557CW-02B	BAY15d (P21/5W)	Page 156	12	2/0.4	-	6000	-	Cool White	2	10	20 <sup>P.134</sup>
1557R-02B	BAY15d (P21/5W)	Page 156	12	2/0.4	-	-	617-621	Red	2	10	20 <sup>P.134</sup>
1557YE-02B	BAY15d (P21/5W)	Page 156	12	2/0.4	-	-	592	Amber	2	10	20 <sup>P.134</sup>
3557CW-02B	W2.5x16q (P27/7W)	Page 156	12	1.42/0.54	-	6000	-	Cool White	2	10	24 <sup>P.134</sup>
3557R-02B	W2.5x16q (P27/7W)	Page 156	12	1.42/0.54	-	-	617-621	Red	2	10	24 <sup>P.134</sup>
3557YE-02B	W2.5x16q (P27/7W)	Page 156	12	1.42/0.54	-	-	592	Amber	2	10	24 <sup>P.134</sup>
5301CW	PG20-1 (PS19W)	4052899605008	12	3	-	6000	-	Cool White	-	-	16 <sup>P.134</sup>
5828CW	PG18.5d-1 (P13W)	4052899604964	12	3	-	6000	-	Cool White	-	-	14 <sup>P.134</sup>
7556CW-02B	BA15s (P21W)	Page 156	12	2	-	6000	-	Cool White	2	10	18 <sup>P.134</sup>
7556R-02B	BA15s (P21W)	Page 156	12	2	-	-	617-621	Red	2	10	18 <sup>P.134</sup>
7556YE-02B	BA15s (P21W)	Page 156	12	2	-	-	592	Amber	2	10	18 <sup>P.134</sup>
7557YE-02B	BAU15s (PY21W)	Page 156	12	2	-	-	592	Amber	2	10	22 <sup>P.134</sup>
7905CW-02B	W3x16d (W21W)	Page 156	12	3	-	6000	-	Cool White	2	10	31 <sup>P.134</sup>
7905R-02B	W3x16d (W21W)	Page 156	12	1.5	-	-	617-621	Red	2	10	31 <sup>P.134</sup>
7905YE-02B	W3x16d (W21W)	Page 156	12	1.5	-	-	592	Amber	2	10	31 <sup>P.134</sup>
7915CW-02B	W3x16q (W21/5W)	Page 156	12	3	-	6000	-	Cool White	2	10	33 <sup>P.134</sup>
7915R-02B	W3x16q (W21/5W)	Page 156	12	1.5	-	-	617-621	Red	2	10	33 <sup>P.134</sup>
7915YE-02B	W3x16q (W21/5W)	Page 156	12	1.5	-	-	592	Amber	2	10	33 <sup>P.134</sup>
9213CW-02B	W2.1x9.5d (W16W)	Page 156	12	3	-	6000	-	Cool White	2	10	29 <sup>P.134</sup>
9213R-02B	W2.1x9.5d (W16W)	Page 156	12	2	-	-	617-621	Red	2	10	29 <sup>P.134</sup>

**LEDriving® SL**

1458CW-02B	BAY15d (P21/5W)	Page 156	12	2/0.4	-	6000	-	Cool White	2	10	21 <sup>P.134</sup>
1458R-02B	BAY15d (P21/5W)	Page 156	12	2/0.4	-	-	617-621	Red	2	10	21 <sup>P.134</sup>
1458YE-02B	BAY15d (P21/5W)	Page 156	12	2/0.4	-	-	592	Amber	2	10	21 <sup>P.134</sup>
3301CW	PG20-1 (PS19W)	4052899605022	12	1.8	-	6000	-	Cool White	-	-	17 <sup>P.134</sup>
3828CW	PG18.5d-1 (P13W)	4052899604988	12	1.8	-	6000	-	Cool White	-	-	15 <sup>P.134</sup>
3548CW-02B	W2.5x16q (P27/7W)	Page 157	12	1.7	-	6000	-	Cool White	2	10	25 <sup>P.134</sup>
3548R-02B	W2.5x16q (P27/7W)	Page 157	12	1.7	-	-	617-621	Red	2	10	25 <sup>P.134</sup>
3548YE-02B	W2.5x16q (P27/7W)	Page 157	12	1.9	-	-	592	Amber	2	10	25 <sup>P.134</sup>
7458CW-02B	BA15s (P21W)	Page 157	12	1.4	-	6000	-	Cool White	2	10	19 <sup>P.134</sup>
7458R-02B	BA15s (P21W)	Page 157	12	1.4	-	-	617-621	Red	2	10	19 <sup>P.134</sup>
7458YE-02B	BA15s (P21W)	Page 157	12	1.3	-	-	592	Amber	2	10	19 <sup>P.134</sup>
7459YE-02B	BAU15s (PY21W)	Page 157	12	1.3	-	-	592	Amber	2	10	23 <sup>P.134</sup>
7706CW-02B	W3x16d (W21W)	Page 157	12	1.4	-	6000	-	Cool White	2	10	32 <sup>P.134</sup>
7706R-02B	W3x16d (W21W)	Page 157	12	1.4	-	-	617-621	Red	2	10	32 <sup>P.134</sup>
7706YE-02B	W3x16d (W21W)	Page 157	12	1.3	-	-	592	Amber	2	10	32 <sup>P.134</sup>
7716CW-02B	W3x16q (W21/5W)	Page 157	12	1.7	-	6000	-	Cool White	2	10	34 <sup>P.134</sup>
7716R-02B	W3x16q (W21/5W)	Page 157	12	1.7	-	-	617-621	Red	2	10	34 <sup>P.134</sup>
7716YE-02B	W3x16q (W21/5W)	Page 157	12	1.9	-	-	592	Amber	2	10	34 <sup>P.134</sup>
9212CW-02B	W2.1x9.5d (W16W)	Page 157	12	1.8	-	6000	-	Cool White	2	10	30 <sup>P.134</sup>

**Replace your conventional lamps with LED retrofit lamps.**  
 Visit [www.osram.com/retrofit-exchange](http://www.osram.com/retrofit-exchange)



# OSRAM LEDriving® SL

## Wide range of interior lamps in different light colors

From dome light to foot area, from glove box to trunk, simply replace old lamps with OSRAM's plug-and-play LEDriving® PREMIUM SL and LEDriving® SL to benefit from highly energy-efficient bright LED light in different color temperatures.



### Features of LEDriving® PREMIUM SL<sup>1)2)</sup>

- High color temperatures of up to 6,000 K
- Superior brightness
- Replaces conventional lamps for interior application
- Premium OSRAM quality
- Long lifetime of up to 5,000 h, shockproof and vibration-proof with up to 80% less energy consumption<sup>3)</sup>



### Benefits of LEDriving® PREMIUM SL<sup>1)2)</sup>

- Wide range of different light colors for a variety of customization options
- Non-selective illumination thanks to homogeneous light distribution
- Smart electronics for easy installation
- 6-year guarantee<sup>4)</sup>
- More durability and very energy-efficient



### Features of LEDriving® SL<sup>1)2)</sup>

- High color temperatures of up to 6,000 K
- High brightness
- Replaces conventional lamps for interior application
- OSRAM quality
- Lifetime of up to 2,500 h with low energy consumption



### Benefits of LEDriving® SL<sup>1)2)</sup>

- Multiple light colors for a variety of customization options
- Non-selective illumination thanks to homogeneous light distribution
- Simple plug & play LED replacement
- 4-year guarantee<sup>4)</sup>
- Durable and energy-efficient

**OSRAM LEDriving® SL and LEDriving® PREMIUM SL – INTERIOR<sup>1)</sup> product range**



Product Reference		Product Number	V	W	$\frac{l}{[mm]}$	K	$\lambda$ [nm]	COLOR		No.
-------------------	--	----------------	---	---	------------------	---	----------------	-------	--	-----

**LEDriving® PREMIUM SL**

2850WW-02B	W2.1x9.5d (W5W)	Page 156	12	1	-	4000	-	Warm White	2	10	27 <sup>P.134</sup>
2850CW-02B	W2.1x9.5d (W5W)	Page 156	12	1	-	6000	-	Cool White	2	10	27 <sup>P.134</sup>
2850BL-02B	W2.1x9.5d (W5W)	Page 156	12	1	-	-	430-490	Blue	2	10	27 <sup>P.134</sup>
2855YE-02B	W2.1x9.5d (WY5W)	Page 156	12	1	-	-	592	Amber	2	10	27 <sup>P.134</sup>
3850WW-02B	BA9s (T4W)	Page 156	12	1	-	4000	-	Warm White	2	10	26 <sup>P.134</sup>
3850CW-02B	BA9s (T4W)	Page 156	12	1	-	6000	-	Cool White	2	10	26 <sup>P.134</sup>
6497WW-01B	SV8.5-8 -	Page 156	12	1	31	4000	-	Warm White	1	5	8 <sup>P.134</sup>
6497CW-01B	SV8.5-8 -	Page 156	12	1	31	6000	-	Cool White	1	5	8 <sup>P.134</sup>
6498WW-01B	SV8.5-8 (C5W)	Page 156	12	1	36	4000	-	Warm White	1	5	9 <sup>P.134</sup>
6498CW-01B	SV8.5-8 (C5W)	Page 156	12	1	36	6000	-	Cool White	1	5	9 <sup>P.134</sup>
6499WW-01B	SV8.5-8 -	Page 156	12	1	41	4000	-	Warm White	1	5	10 <sup>P.134</sup>
6499CW-01B	SV8.5-8 -	Page 156	12	1	41	6000	-	Cool White	1	5	10 <sup>P.134</sup>

**LEDriving® SL**

2880BL-02B	W2.1x9.5d (W5W)	Page 157	12	1	-	-	460-485	Blue	2	10	28 <sup>P.134</sup>
2880CW-02B	W2.1x9.5d (W5W)	Page 157	12	1	-	6000	-	Cool White	2	20	28 <sup>P.134</sup>
2880YE-02B	W2.1x9.5d (WY5W)	Page 157	12	1	-	-	592	Amber	2	10	28 <sup>P.134</sup>
2880R-02B	W2.1x9.5d (W5W)	Page 157	12	1	-	-	617-621	Red	2	10	28 <sup>P.134</sup>
2880GR-02B	W2.1x9.5d (W5W)	Page 157	12	1	-	-	617-621	Green	2	10	28 <sup>P.134</sup>
6431CW-01B	SV8.5-8 -	Page 157	12	0.5	31	6000	-	Cool White	1	5	11 <sup>P.134</sup>
6431BL-01B	SV8.5-8 -	Page 157	12	0.5	31	-	460-485	Blue	1	5	11 <sup>P.134</sup>
6436CW-01B	SV8.5-8 (C5W)	Page 157	12	0.5	36	6000	-	Cool White	1	5	12 <sup>P.134</sup>
6436BL-01B	SV8.5-8 (C5W)	Page 157	12	0.5	36	-	460-485	Blue	1	5	12 <sup>P.134</sup>
6441CW-01B	SV8.5-8 -	Page 157	12	0.5	41	6000	-	Cool White	1	5	13 <sup>P.134</sup>
6441BL-01B	SV8.5-8 -	Page 157	12	0.5	41	-	460-485	Blue	1	5	13 <sup>P.134</sup>

**i** Replace your conventional lamps with LED retrofit lamps.  
 Visit [www.osram.com/retrofit-exchange](http://www.osram.com/retrofit-exchange)

- 1) These products do not have ECE approval. This means they must not be used on public roads in any exterior application. Use on public roads leads to cancellation of operating license and loss of insurance coverage. Several countries do not allow sale and use of these products. Please contact your local distributor for information on the availability in your country.
- 2) LEDriving® CANBUS CONTROL UNIT avoids error messages on the board computer when using LED lamps within 5 W (LEDCBCTRL101 P.34) or 21 W (LEDCBCTRL102 P.34) applications
- 3) Compared with conventional lamps
- 4) Refer to [www.osram.com/am-guarantee](http://www.osram.com/am-guarantee) for precise conditions

# OSRAM LEDriving® HL and PREMIUM SL

## Bright light for trucks (24V)

Simply replace old truck lamps with OSRAM's LED replacement lamps for forward and interior lighting to benefit from highly energy-efficient bright LED light. LEDriving® HL for high and low beam applications are 12 V and 24 V compatible and stand out with very compact design, high compatibility and easy installation. LEDriving® PREMIUM SL, LED signal lamps, are available in cool and warm white light for ambient lighting.



### Features<sup>1)</sup> of LEDriving® HL

- Cool White color temperature of 6,000 K
- Superior brightness
- Very compact LED replacement for conventional H4, H7, HB4 and H11 high and low beam lamps
- Premium OSRAM quality made in Italy
- Long lifetime of up to 5,000 h
- Integrated electronics, no external driver

### Benefits<sup>1)</sup> of LEDriving® HL

- Better visibility thanks to daylight effect
- More light allows to see farther and therefore react sooner. Signs, obstacles and hazards can be recognized sooner
- Reduced glaring thanks to an optimized light distribution
- 5-year guarantee<sup>2)</sup>
- More durability due to LED technology
- Simple plug & play installation and improved compatibility



### Features<sup>1)3)</sup> of LEDriving® PREMIUM SL

- High color temperatures of up to 6,000 K
- Superior brightness
- Replaces conventional lamps with 24 V for interior application
- Premium OSRAM quality
- Long lifetime of up to 5,000 h, shockproof and vibration-proof with up to 80% less energy consumption<sup>4)</sup>

### Benefits<sup>1)3)</sup> of LEDriving® PREMIUM SL

- Available in Cool White and Warm White
- Non-selective illumination thanks to homogeneous light distribution
- Smart electronics for easy installation
- 6-year guarantee<sup>2)</sup>
- More durability and very energy-efficient







**OSRAM LEDriving® HL (24V) Truck product range**



Product Reference	Product Number	V	W	K	COLOR			No.
9726CW P43t (H4)	4052899 <b>605121</b>	12/24	14	6000	Cool White	2	4	1 <sup>P.134</sup>
67210CW PX26d (H7)	4052899 <b>605084</b>	12/24	14	6000	Cool White	2	4	2 <sup>P.134</sup>
67211CW <sup>3)</sup> PGJ19-2 (H11)	4052899 <b>605107</b>	12/24	14	6000	Cool White	2	4	3 <sup>P.134</sup>
9736CW P22d (HB4)	4052899 <b>605145</b>	12/24	14	6000	Cool White	2	4	4 <sup>P.134</sup>

**OSRAM LEDriving® PREMIUM SL (24V) Truck product range**

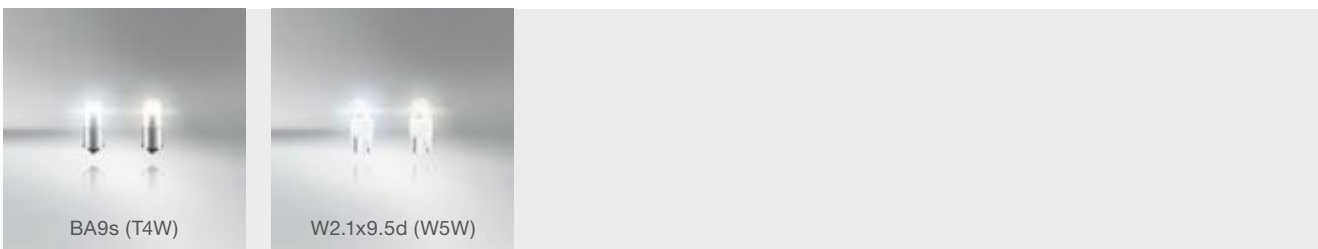

Product Reference	Product Number	V	W	I [mm]	K	λ [nm]	COLOR		No.
<b>LEDriving® PREMIUM SL (24V)</b>									
2824WW-02B W2.1x9.5d (W5W)	Page 156	24	1	-	4000	-	Warm White	2	10 27 <sup>P.134</sup>
2824CW-02B W2.1x9.5d (W5W)	Page 156	24	1	-	6000	-	Cool White	2	10 27 <sup>P.134</sup>
3924WW-02B BA9s (T4W)	Page 156	24	1	-	4000	-	Warm White	2	10 26 <sup>P.134</sup>
3924CW-02B BA9s (T4W)	Page 156	24	1	-	6000	-	Cool White	2	10 26 <sup>P.134</sup>



**Replace your conventional lamps with LED retrofit lamps.**  
 Visit [www.osram.com/retrofit-exchange](http://www.osram.com/retrofit-exchange)

- 1) These products do not have ECE approval. This means they must not be used on public roads in any exterior application. Use on public roads leads to cancellation of operating license and loss of insurance coverage. Several countries do not allow sale and use of these products. Please contact your local distributor for information on the availability in your country.
- 2) Refer to [www.osram.com/am-guarantee](http://www.osram.com/am-guarantee) for precise conditions
- 3) LEDriving® CANBUS CONTROL UNIT avoids error messages on the board computer when using LED lamps within 5 W (LEDCBCTRL101 P.34), 21 W (LEDCBCTRL102 P.34) or 50 W (LEDCBCTRL103 P.34) applications
- 4) Compared with conventional lamps

# OSRAM LEDriving® CANBUS CONTROL UNIT

## Making LED upgrades fit right in

LED lamps are highly energy-efficient. But their lower wattages prompt board computer warnings. The OSRAM solution: the Canbus Control Unit. It prevents warnings and allows the lightsource to run cool and retain their brightness. Simply clip the warning canceller between lamp and socket, and enjoy the full benefits of your OSRAM LED retrofits and fog lights.



### Features

- Bypasses the vehicle's outage detection system to prevent error messages in board computers prompted by LED lamps with lower wattages
- Available for 4-5 W, 21 or 50 W
- Robust component



### Benefits

- Easily clips onto wires
- Enjoy full benefits of your OSRAM LED retrofits and fog lights
- Original OSRAM accessory
- 3-year guarantee<sup>1)</sup>

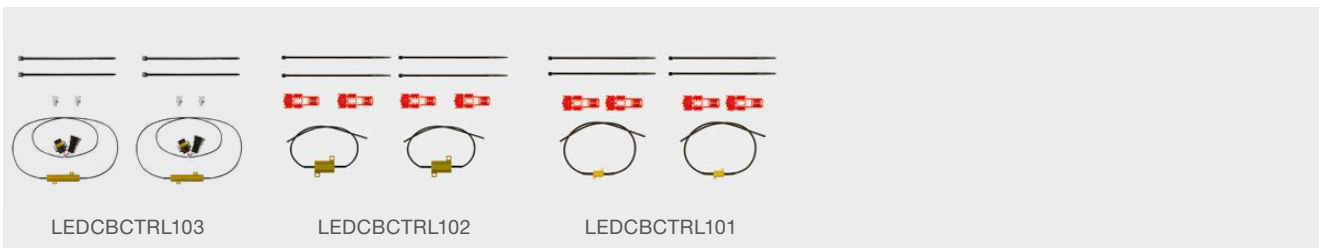

**OSRAM LEDDriving® CANBUS CONTROL UNIT product range<sup>1)</sup>**



Product Reference	Product Number	V	W			 No.
LEDCBCTRL103	40528993 <b>27375</b>	12	50	2	10	-
LEDCBCTRL102	40528993 <b>01993</b>	12	21	2	10	-
LEDCBCTRL101	40528990 <b>90873</b>	12	5	2	10	-

<sup>1)</sup> Refer to [www.osram.com/am-guarantee](http://www.osram.com/am-guarantee) for precise conditions

## Xenon headlight lamps – fascinatingly bright

OSRAM xenon lamps generate up to 200% more brightness compared to the minimum legal standard – at impressive color temperatures, as well as significantly lower energy consumption and longer life than halogen lamps. OSRAM cutting-edge xenon lighting concepts, however, allow far more than just driving comfort, underlining personal style and demonstrating individual environmental awareness. They are suitable for cars, trucks, buses and commercial vehicles.





# OSRAM Trust Program

## Verify original OSRAM xenon lamps

OSRAM strives to deliver premium-quality products – a fact that has garnered the attention of manufacturers who flood the market with fakes. This is not just an economic issue, but one that puts customer safety at stake. The OSRAM Trust Program helps customers to verify OSRAM original xenon products.

### Why trusting OSRAM is always the right thing to do

There are already a certain number of fake lamps circulating, many of which claim to be OSRAM XENARC® lamps. Some of those fakes are easy to spot. But some are so cleverly faked, even the eye of a professional can't spot the difference.

That's why we have implemented a 2-step security process. It's easy to use and guaranteed to get you results within seconds.

### OSRAM XENARC® lamps

- XENARC® NIGHT BREAKER® LASER
- XENARC® COOL BLUE® INTENSE
- XENARC® COOL BLUE® BOOST
- XENARC® ULTRA LIFE
- XENARC® ORIGINAL



### Safety features

One part of the OSRAM Trust Program is to implement two safety features into the manufacturing process. Starting with OSRAM XENARC® products, you can verify your lamps using the following two safety features:



### Packaging label code

Every original OSRAM xenon packaging has a unique 7-digit label code **a** attached, the last 3 digits of which can be seen as a hologram in the lower right corner **b**. Next you'll find a security strip with microtext which is legible with a magnifying glass **c**. Finally, there's an OSRAM logo, the URL [www.osram.com/trust](http://www.osram.com/trust) and a QR code leading to our OSRAM Trust Program website.

### Unique lamp data on each lamp

Each safety label is assigned to exactly one lamp during the manufacturing process. You can find the unique lamp data on the base of your lamp.



### Online check tool

This is part 2 of the OSRAM Trust Program. We strongly encourage you to try these next steps two or three times in a row – it's fast and simple:



[www.osram.com/trust](http://www.osram.com/trust)



### 1 Enter 7-digit label code

When at [osram.com/trust](http://osram.com/trust), select the tab "Verify your product", then enter the 7-digit label code from the packaging. If you're scanning a QR code right from the packaging, the 7-digit label code is already being auto-filled.

### 2 Verify lamp data

After your 7-digit label code has been verified, you will be asked to check whether the automatically prompted lamp data matches the data which is displayed on the base of your lamp.

# OSRAM XENARC® NIGHT BREAKER® LASER

## Brightest OSRAM xenon light

With up to 200% more brightness on the road compared to the minimum legal standard, these exceptionally bright headlight lamps offer up to 20% whiter xenon light<sup>1)</sup> and a beam length of up to 250 m.



### Features

- Up to 200% more brightness<sup>1)</sup>
- Up to 250 m long beam
- Up to 20% whiter light<sup>1)</sup>
- Optimized light distribution for higher performance

### Benefits

- More light allows to see farther and therefore react sooner
- Better visibility
- Close to laser look
- Signs, obstacles and hazards can be recognized sooner

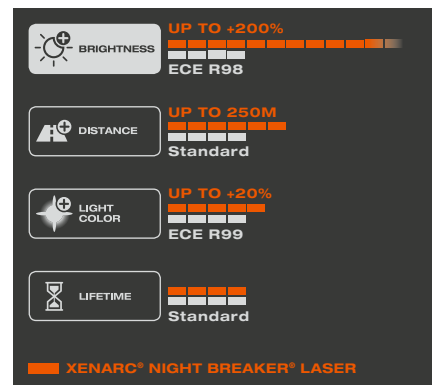





**OSRAM XENARC® NIGHT BREAKER® LASER product range**

Product Reference	ECE	Product Number	V	W		lm	K			No.
66140XNL <sup>2)3)</sup>	D1S <sup>4)</sup>	4052899 <b>992870</b>	85	35	PK32d-2	3200 <sup>5)</sup>	4500	1	4	1 <sup>P.138</sup>
66140XNL-HCB <sup>2)3)</sup>	D1S <sup>4)</sup>	Page 153	85	35	PK32d-2	3200 <sup>5)</sup>	4500	2	4	1 <sup>P.138</sup>
66240XNL <sup>2)3)</sup>	D2S <sup>4)</sup>	4052899 <b>993259</b>	85	35	P32d-2	3200 <sup>5)</sup>	4500	1	4	3 <sup>P.138</sup>
66240XNL-HCB <sup>2)3)</sup>	D2S <sup>4)</sup>	Page 153	85	35	P32d-2	3200 <sup>5)</sup>	4500	2	4	3 <sup>P.138</sup>
66340XNL <sup>2)3)</sup>	D3S <sup>4)</sup>	4052899 <b>992979</b>	42	35	PK32d-5	3200 <sup>5)</sup>	4400	1	4	1 <sup>P.138</sup>
66340XNL-HCB <sup>2)3)</sup>	D3S <sup>4)</sup>	Page 153	42	35	PK32d-5	3200 <sup>5)</sup>	4400	2	4	1 <sup>P.138</sup>
66440XNL <sup>2)3)</sup>	D4S <sup>4)</sup>	4052899 <b>992993</b>	42	35	P32d-5	3200 <sup>5)</sup>	4400	1	4	3 <sup>P.138</sup>
66440XNL-HCB <sup>2)3)</sup>	D4S <sup>4)</sup>	Page 153	42	35	P32d-5	3200 <sup>5)</sup>	4400	2	4	3 <sup>P.138</sup>

1) Compared to minimum ECE R98/R99 requirements  
 2) To be operated only with approved electronic control gear  
 3) XENARC® lamps should be replaced by a qualified mechanic  
 4) Reduced UV emission | For projection headlights | ECE approval and DOT label  
 5) ± 450lm

# OSRAM XENARC® COOL BLUE® INTENSE

## Extra-blue xenon light

Exceptionally bright, high contrast and brilliantly blue with up to 6,000 K:  
The high-tech xenon light comes with a highly efficient technology, brilliant effect and no-compromise design.



### Features

- Extra blue light<sup>1)</sup>
- Color temperatures of up to 6,000 K
- Up to 20% more brightness<sup>2)</sup>

### Benefits

- Modern look on the road
- High contrast
- More light allows to see farther and therefore react sooner

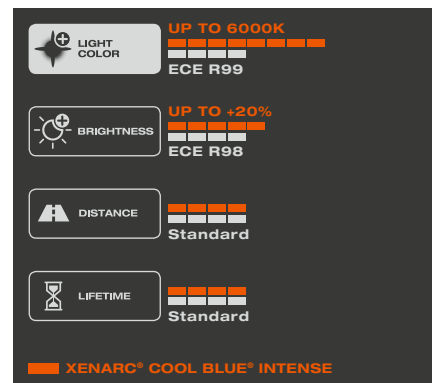



**OSRAM XENARC® COOL BLUE® INTENSE product range**

Product Reference	ECE	Product Number	V	W		lm	K			
66140CBI <sup>(3)4)</sup>	D1S <sup>(5)</sup>	4052899 <b>220720</b>	85	35	PK32d-2	3200 <sup>(7)</sup>	6000 <sup>(8)</sup>	1	4	1 <sup>P.138</sup>
66140CBI-HCB <sup>(3)4)</sup>	D1S <sup>(5)</sup>	Page 153	85	35	PK32d-2	3200 <sup>(7)</sup>	6000 <sup>(8)</sup>	2	4	1 <sup>P.138</sup>
66150CBI <sup>(3)4)</sup>	D1R <sup>(6)</sup>	4052899 <b>339903</b>	85	35	PK32d-3	2800 <sup>(7)</sup>	6000 <sup>(8)</sup>	1	4	2 <sup>P.138</sup>
66240CBI <sup>(3)4)</sup>	D2S <sup>(5)</sup>	400832 <b>1401359</b>	85	35	P32d-2	3200 <sup>(7)</sup>	6000 <sup>(8)</sup>	1	4	3 <sup>P.138</sup>
66240CBI-HCB <sup>(3)4)</sup>	D2S <sup>(5)</sup>	Page 153	85	35	P32d-2	3200 <sup>(7)</sup>	6000 <sup>(8)</sup>	2	4	3 <sup>P.138</sup>
66250CBI <sup>(3)4)</sup>	D2R <sup>(6)</sup>	400832 <b>1401533</b>	85	35	P32d-3	2800 <sup>(7)</sup>	6000 <sup>(8)</sup>	1	4	4 <sup>P.138</sup>
66340CB <sup>(3)4)</sup>	D3S <sup>(5)</sup>	4052899 <b>148710</b>	42	35	PK32d-5	3200 <sup>(7)</sup>	6000 <sup>(8)</sup>	1	4	1 <sup>P.138</sup>
66340CBI-HCB <sup>(3)4)</sup>	D3S <sup>(5)</sup>	Page 153	42	35	PK32d-5	3200 <sup>(7)</sup>	6000 <sup>(8)</sup>	2	4	1 <sup>P.138</sup>
66440CBI <sup>(3)4)</sup>	D4S <sup>(5)</sup>	4052899 <b>125582</b>	42	35	P32d-5	3200 <sup>(7)</sup>	6000 <sup>(8)</sup>	1	4	3 <sup>P.138</sup>
66440CBI-HCB <sup>(3)4)</sup>	D4S <sup>(5)</sup>	Page 153	42	35	P32d-5	3200 <sup>(7)</sup>	6000 <sup>(8)</sup>	2	4	3 <sup>P.138</sup>

1) From a special filling system instead of conventional coating  
 2) Compared to minimum ECE R98 requirements  
 3) To be operated only with approved electronic control gear  
 4) XENARC® lamps should be replaced by a qualified mechanic  
 5) Reduced UV emission | For projection headlights | ECE approval and DOT label  
 6) Reduced UV emission | With anti-glare strip for reflection headlights | ECE approval and DOT label  
 7) ± 450 lm  
 8) Up to

# OSRAM XENARC® ULTRA LIFE

## Superior life and 10-year guarantee

For additional reliability: With up to four times the lifespan of a standard lamp, XENARC® ULTRA LIFE headlight lamps come with a 10-year guarantee<sup>1)</sup>.



### Features

- 10-year guarantee<sup>1)</sup>
- Up to 4 times longer lifetime<sup>2)</sup>
- Up to 300,000 km service life<sup>3)</sup>
- More durability

### Benefits

- Additional comfort due to reliable quality
- Saves time due to fewer workshop visits
- Additional reliability
- Longer replacement cycles

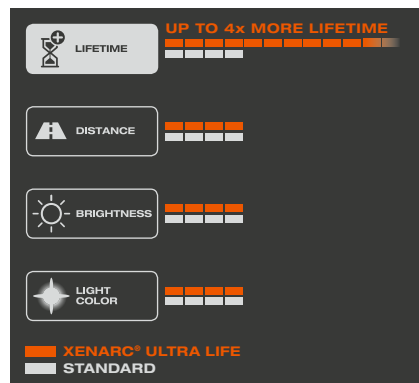



### OSRAM XENARC® ULTRA LIFE product range

Product Reference	ECE	Product Number	V	W		lm	K				No.
66140ULT <sup>4)5)</sup>	D1S <sup>6)</sup>	4052899 <b>425514</b>	85	35	PK32d-2	3200 <sup>7)</sup>	4300	1	4		1 <sup>P.138</sup>
66140ULT-HCB <sup>4)5)</sup>	D1S <sup>6)</sup>	Page 153	85	35	PK32d-2	3200 <sup>7)</sup>	4300	2	4		1 <sup>P.138</sup>
66240ULT <sup>4)5)</sup>	D2S <sup>6)</sup>	4052899 <b>425576</b>	85	35	P32d-2	3200 <sup>7)</sup>	4300	1	4		3 <sup>P.138</sup>
66240ULT-HCB <sup>4)5)</sup>	D2S <sup>6)</sup>	Page 153	85	35	P32d-2	3200 <sup>7)</sup>	4300	2	4		3 <sup>P.138</sup>
66340ULT <sup>4)5)</sup>	D3S <sup>6)</sup>	4052899 <b>425606</b>	42	35	PK32d-5	3200 <sup>7)</sup>	4300	1	4		1 <sup>P.138</sup>
66340ULT-HCB <sup>4)5)</sup>	D3S <sup>6)</sup>	Page 154	42	35	PK32d-5	3200 <sup>7)</sup>	4300	2	4		1 <sup>P.138</sup>
66440ULT <sup>4)5)</sup>	D4S <sup>6)</sup>	4052899 <b>425637</b>	42	35	P32d-5	3200 <sup>7)</sup>	4300	1	4		3 <sup>P.138</sup>
66440ULT-HCB <sup>4)5)</sup>	D4S <sup>6)</sup>	Page 154	42	35	P32d-5	3200 <sup>7)</sup>	4300	2	4		3 <sup>P.138</sup>

1) With online product registration. Refer to [www.osram.com/am-guarantee](http://www.osram.com/am-guarantee) for precise conditions and registration

2) Compared to standard xenon lamps

3) With an average annual mileage of 14,259 km and 60% light on

4) To be operated only with approved electronic control gear

5) XENARC® lamps should be replaced by a qualified mechanic

6) Reduced UV emission | For projection headlights | ECE approval and DOT label

7) ± 450 lm

# OSRAM XENARC® ORIGINAL

## 4-year guarantee

XENARC® ORIGINAL lamps impress with a wide product range and the reliable OEM quality. Successfully used in millions of new automobiles from renowned manufacturers, whether as standard initial equipment or original spare parts.



### Features

- 4-year guarantee<sup>1)</sup>
- OEM Quality
- Original spare parts that exceed all ECE minimum standards
- Wide product range

### Benefits

- Additional comfort due to reliable quality
- Tried and trusted in millions of vehicles of well-known manufacturers
- Premium quality made in Germany
- Suitable for many xenon headlights



**OSRAM XENARC® ORIGINAL product range**

Product Reference	ECE	Product Number	V	W	Im	K				No.
66140 <sup>2)3)</sup>	D1S <sup>4)</sup>	4008321184276	85	35	PK32d-2	3200 <sup>6)</sup>	4300	1	4	1 <sup>P.138</sup>
66140-1SCB <sup>2)3)</sup>	D1S <sup>4)</sup>	4052899600423	85	35	PK32d-2	3200 <sup>6)</sup>	4300	1	4	1 <sup>P.138</sup>
66150 <sup>2)3)</sup>	D1R <sup>5)</sup>	4052899339828	85	35	PK32d-3	2800 <sup>6)</sup>	4300	1	4	2 <sup>P.138</sup>
66240 <sup>2)3)</sup>	D2S <sup>4)</sup>	4008321184573	85	35	P32d-2	3200 <sup>6)</sup>	4300	1	4	3 <sup>P.138</sup>
66240-1SCB <sup>2)3)</sup>	D2S <sup>4)</sup>	4052899600447	85	35	P32d-2	3200 <sup>6)</sup>	4300	1	4	3 <sup>P.138</sup>
66250 <sup>2)3)</sup>	D2R <sup>5)</sup>	4008321184634	85	35	P32d-3	2800 <sup>6)</sup>	4300	1	4	4 <sup>P.138</sup>
66340 <sup>2)3)</sup>	D3S <sup>4)</sup>	4052899199569	42	35	PK32d-5	3200 <sup>6)</sup>	4300	1	4	1 <sup>P.138</sup>
66340-1SCB <sup>2)3)</sup>	D3S <sup>4)</sup>	4052899600485	42	35	PK32d-5	3200 <sup>6)</sup>	4300	1	4	1 <sup>P.138</sup>
66350 <sup>2)3)</sup>	D3R <sup>5)</sup>	4008321129857	42	35	PK32d-6	2800 <sup>6)</sup>	4300	1	4	2 <sup>P.138</sup>
66440 <sup>2)3)</sup>	D4S <sup>4)</sup>	4008321349392	42	35	P32d-5	3200 <sup>6)</sup>	4300	1	4	3 <sup>P.138</sup>
66440-1SCB <sup>2)3)</sup>	D4S <sup>4)</sup>	4052899600508	42	35	P32d-5	3200 <sup>6)</sup>	4300	1	4	3 <sup>P.138</sup>
66450 <sup>2)3)</sup>	D4R <sup>5)</sup>	4008321349576	42	35	P32d-6	2800 <sup>6)</sup>	4300	1	4	4 <sup>P.138</sup>
66540 <sup>3)</sup>	D5S <sup>4)</sup>	4052899600522	12	25	PK32d-7	2000 <sup>7)</sup>	4800	1	4	-
66548 <sup>2)3)</sup>	D8S <sup>4)</sup>	4008321787019	42	25	PK32d-1	2000 <sup>8)</sup>	4500	1	4	2 <sup>P.138</sup>

D5S  
AVAILABLE  
SOON

A perfectly matched OSRAM system solution with ballast, terminal and connecting cables is available for all XENARC® D1S/R, D3S/R and D8S lamps. Please consult your OSRAM contact if required.

- 1) Refer to [www.osram.com/am-guarantee](http://www.osram.com/am-guarantee) for precise conditions
- 2) To be operated only with approved electronic control gear
- 3) XENARC® lamps should be replaced by a qualified mechanic
- 4) Reduced UV emission | For projection headlights | ECE approval and DOT label
- 5) Reduced UV emission | With anti-glare strip for projection headlights | ECE approval and DOT label
- 6) ± 450 lm
- 7) + 300 lm/-200 lm
- 8) ± 300 lm





## Halogen lamps for cars – the most popular classic light, for good reason

Long life or high performance, optimized illumination, best quality, convincing price-performance ratio – for these excellent reasons, OSRAM halogen solutions are the best-selling classics among headlight lamps. From original, performance, design, and comfort products, each customer can choose the exact lamp which best fits their personal needs – whether it is an original spare part or a value-added product.

# OSRAM NIGHT BREAKER® LASER

## Brightest OSRAM halogen light

Outshining all other OSRAM halogen lamps: Innovative laser ablation technology makes the NIGHT BREAKER® LASER up to 150% brighter than the minimum legal standard.



### Features

- Up to 150% more brightness<sup>1)</sup>
- Up to 150 m long beam
- Up to 20% whiter light<sup>1)</sup>
- More light performance due to innovative laser ablation technology<sup>2)</sup>
- Unique design with laser-etched product name<sup>2)</sup>

### Benefits

- More light allows to see farther and therefore react sooner
- Better visibility
- Modern look
- Signs, obstacles and hazards can be recognized sooner

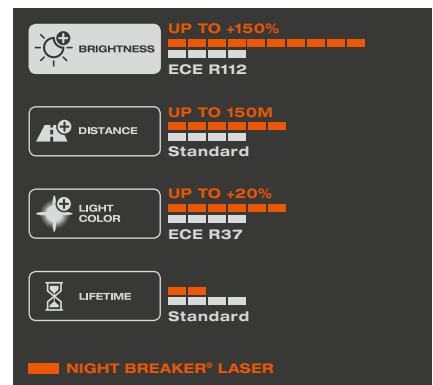



**OSRAM NIGHT BREAKER® LASER product range**

Product Reference	ECE	Product Number	V	W					No.
64150NL	H1	4052899 <b>991309</b>	12	55	P14.5s	1	100	5 <sup>P.138</sup>	
64150NL-01B	H1	Page 154	12	55	P14.5s	1	10	5 <sup>P.138</sup>	
64150NL-HCB	H1	Page 154	12	55	P14.5s	2	20	5 <sup>P.138</sup>	
64151NL	H3	4052899 <b>991330</b>	12	55	PK22s	1	100	7 <sup>P.138</sup>	
64151NL-HCB	H3	Page 154	12	55	PK22s	1	10	7 <sup>P.138</sup>	
64193NL	H4	4052899 <b>991361</b>	12	60/55	P43t	1	100	8 <sup>P.138</sup>	
64193NL-01B	H4	Page 154	12	60/55	P43t	1	10	8 <sup>P.138</sup>	
64193NL-HCB	H4	Page 154	12	60/55	P43t	2	20	8 <sup>P.138</sup>	
64210NL	H7	4052899 <b>991392</b>	12	55	PX26d	1	100	9 <sup>P.138</sup>	
64210NL-01B	H7	Page 154	12	55	PX26d	1	10	9 <sup>P.138</sup>	
64210NL-HCB	H7	Page 154	12	55	PX26d	2	20	9 <sup>P.138</sup>	
64212NL	H8	4052899 <b>998827</b>	12	35	PGJ19-1	1	100	10 <sup>P.138</sup>	
64212NL-HCB	H8	Page 154	12	35	PGJ19-1	2	20	10 <sup>P.138</sup>	
64211NL	H11	4052899 <b>991422</b>	12	55	PGJ19-2	1	100	15 <sup>P.138</sup>	
64211NL-01B	H11	Page 154	12	55	PGJ19-2	1	10	15 <sup>P.138</sup>	
64211NL-HCB	H11	Page 154	12	55	PGJ19-2	2	20	15 <sup>P.138</sup>	
9005NL	HB3	4052899 <b>998858</b>	12	60	P20d	1	100	23 <sup>P.138</sup>	
9005NL-HCB	HB3	Page 154	12	60	P20d	2	20	23 <sup>P.138</sup>	
9006NL	HB4	4052899 <b>998889</b>	12	51	P22d	1	100	25 <sup>P.138</sup>	
9006NL-HCB	HB4	Page 154	12	51	P22d	2	20	25 <sup>P.138</sup>	

1) Compared to minimum ECE R112/R37 requirements

2) H4/H7/H8/H11/HB3/HB4

# OSRAM NIGHT BREAKER® SILVER

## Excellent performance-lifetime ratio

With up to 100% more brightness compared to the minimum legal standard, an excellent choice for motorists with high demands for performance and lifetime.



### Features

- Up to 100% more brightness<sup>1)</sup>
- Up to 130 m long beam
- Excellent performance-lifetime ratio

### Benefits

- More light allows to see farther and therefore react sooner
- Better visibility
- More light at a reasonable lifetime

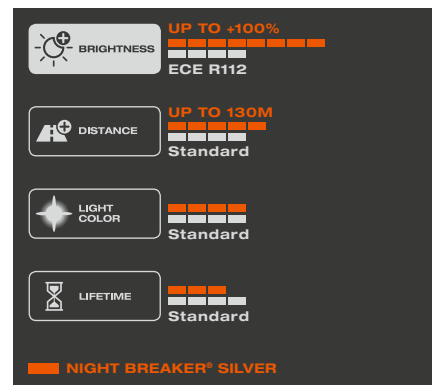



**OSRAM NIGHT BREAKER® SILVER product range**

Product Reference	ECE	Product Number	V	W				
64150NBS	H1	4052899 <b>992573</b>	12	55	P14.5s	1	100	5 <sup>P.138</sup>
64150NBS-01B	H1	Page 154	12	55	P14.5s	1	10	5 <sup>P.138</sup>
64150NBS-HCB	H1	Page 154	12	55	P14.5s	2	20	5 <sup>P.138</sup>
64193NBS	H4	4052899 <b>992603</b>	12	60/55	P43t	1	100	8 <sup>P.138</sup>
64193NBS-01B	H4	Page 154	12	60/55	P43t	1	10	8 <sup>P.138</sup>
64193NBS-HCB	H4	Page 154	12	60/55	P43t	2	20	8 <sup>P.138</sup>
64210NBS	H7	4052899 <b>992634</b>	12	55	PX26d	1	100	9 <sup>P.138</sup>
64210NBS-01B	H7	Page 154	12	55	PX26d	1	10	9 <sup>P.138</sup>
64210NBS-HCB	H7	Page 154	12	55	PX26d	2	20	9 <sup>P.138</sup>
64211NBS	H11	4052899 <b>992665</b>	12	55	PGJ19-2	1	100	15 <sup>P.138</sup>
64211NBS-HCB	H11	Page 154	12	55	PGJ19-2	2	20	15 <sup>P.138</sup>

1) Compared to minimum ECE R112 requirements

# OSRAM COOL BLUE® INTENSE

## Bluish-white light for xenon look

Stylish xenon look for your drive: High-tech halogen lamp, almost in the league of xenon lamps with their powerful bluish-white light.



### Features

- Bluish-white light for xenon look
- Color temperatures of up to 4,200 K
- Up to 20% more brightness<sup>1)</sup>
- Modern design with silver cap<sup>2)</sup>

### Benefits

- Modern and stylish look
- High contrast
- More light allows to see farther and therefore react sooner
- Ideal for use in clear-glass headlights

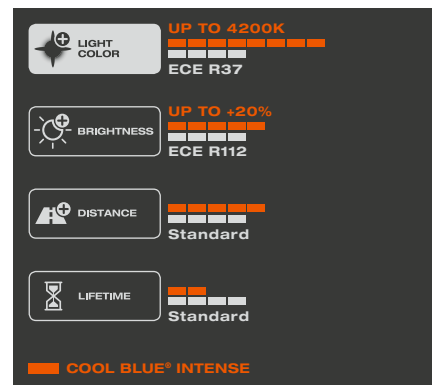



### OSRAM COOL BLUE® INTENSE product range

Product Reference	ECE	Product Number	V	W					No.
64150CBI	H1	4008321655325	12	55	P14.5s	1	100		5 <sup>P.138</sup>
64150CBI-01B	H1	Page 154	12	55	P14.5s	1	10		5 <sup>P.138</sup>
64150CBI-HCB	H1	Page 154	12	55	P14.5s	2	20		5 <sup>P.138</sup>
64151CBI	H3	4008321655462	12	55	PK22s	1	100		7 <sup>P.138</sup>
64193CBI	H4	4008321650894	12	60/55	P43t	1	100		8 <sup>P.138</sup>
64193CBI-01B	H4	Page 154	12	60/55	P43t	1	10		8 <sup>P.138</sup>
64193CBI-HCB	H4	Page 154	12	60/55	P43t	2	20		8 <sup>P.138</sup>
64210CBI	H7	4008321651341	12	55	PX26d	1	100		9 <sup>P.138</sup>
64210CBI-01B	H7	Page 154	12	55	PX26d	1	10		9 <sup>P.138</sup>
64210CBI-HCB	H7	Page 154	12	55	PX26d	2	20		9 <sup>P.138</sup>
64212CBI-HCB	H8	Page 154	12	35	PGJ19-1	2	20		10 <sup>P.138</sup>
64211CBI	H11	4052899433175	12	55	PGJ19-2	1	100		15 <sup>P.138</sup>
64211CBI-HCB	H11	Page 154	12	55	PGJ19-2	2	20		15 <sup>P.138</sup>
64176CBI	H15	4052899932708	12	55/15	PGJ23t-1	1	100		18 <sup>P.138</sup>
64176CBI-HCB	H15	Page 154	12	55/15	PGJ23t-1	2	20		18 <sup>P.138</sup>
64219CBI	H16	4052899268326	12	19	PGJ19-3	1	100		19 <sup>P.138</sup>
64219CBI-HCB	H16	Page 154	12	19	PGJ19-3	2	20		19 <sup>P.138</sup>
880CBI	H27W/1	4052899479999	12	27	PG13	1	100		32 <sup>P.138</sup>
881CBI	H27W/2	4052899480025	12	27	PGJ13	1	100		32 <sup>P.138</sup>
9005CBI-HCB	HB3	Page 154	12	60	P20d	2	20		23 <sup>P.138</sup>
9006CBI-HCB	HB4	Page 154	12	51	P22d	2	20		25 <sup>P.138</sup>
9012CBI	HIR2	4052899455405	12	55	PX22d	1	100		29 <sup>P.138</sup>
2825HCBI	W5W	4008321650849	12	5	W2.1x9.5d	10	50		52 <sup>P.139</sup>
2825HCBI-02B	W5W	Page 154	12	5	W2.1x9.5d	2	20		52 <sup>P.139</sup>

1) Compared to minimum ECE R112 requirements

2) H4, H7, H11, H27W/1, H27W/2, HB4



# OSRAM DIADEM® CHROME and DIADEM®

## Only amber or red during operation

Visual tuning for indicator and tail lamps: The signal lights only emit amber or red light during operation – making them the perfect, attractive light supplement for halogen and xenon headlamps.

### Features of DIADEM® CHROME

- Chrome design
- Only amber when ON
- No irritating color effects
- Cutting edge interference and absorber coating

### Benefits of DIADEM® CHROME

- Attractive light supplement for halogen and xenon headlamps
- Almost invisible when not operating
- Ideal for all indicator lights with clear covers
- Exclusive chrome look

### Features of DIADEM®

- Opal design
- Red or amber when ON
- Up to double the service life<sup>1)</sup>
- State-of-the-art interference coating

### Benefits of DIADEM®

- Attractive light supplement for halogen and xenon headlamps
- Almost invisible when not operating
- Additional reliability
- Opal look

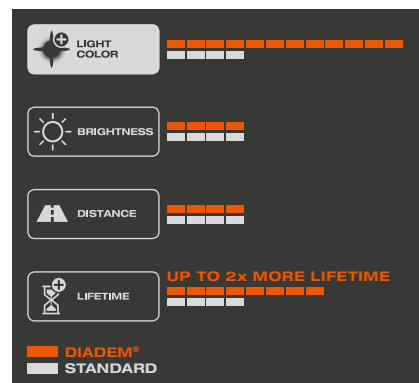
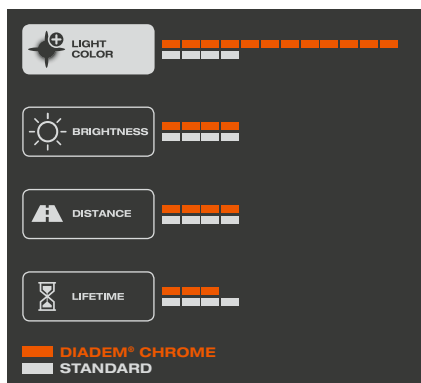





**OSRAM DIADEM® CHROME product range**

Product Reference	ECE	Product Number	V	W				
2827DC-02B <sup>2)</sup>	WY5W	Page 154	12	5	W2.1x9.5d	2	20	52 <sup>P.139</sup>
7507DC-02B <sup>2)</sup>	PY21W	Page 154	12	21	BAU15s	2	20	38 <sup>P.138</sup>

**OSRAM DIADEM® product range**

Product Reference	ECE	Product Number	V	W				
7507LDA-02B <sup>2)</sup>	PY21W	Page 154	12	21	BAU15s	2	20	38 <sup>P.138</sup>
7508LDR-01B <sup>3)</sup>	PR21W	Page 154	12	21	BAW15s	1	10	43 <sup>P.138</sup>
7538LDR-01B <sup>3)</sup>	PR21/5W	Page 154	12	21/5	BAW15d	1	10	44 <sup>P.138</sup>

1) Compared with standard lamps  
 2) Amber lamps for clear indicator lights  
 3) Red light for clear tail/brake lights

# OSRAM ULTRA LIFE

## Longer life and 4-year guarantee

The ULTRA LIFE product family provides more reliability and durability. The lamps last up to four times longer compared with standard lamps and have a rock-solid guarantee of four years with online registration.



### Features

- 4-year guarantee<sup>1)</sup>
- Up to 4 times longer lifetime<sup>2)</sup>
- Up to 100,000 km service life<sup>3)</sup>
- More durability
- Modern design with silver cap (H4/H7/H11)

### Benefits

- Additional comfort due to reliable quality
- Saves time due to fewer workshop visits
- Additional reliability
- Longer replacement cycles
- Ideal for use in clear-glass headlights

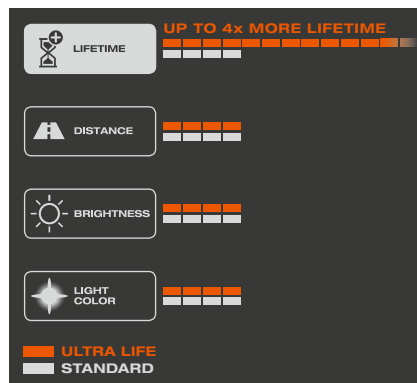



### OSRAM ULTRA LIFE product range

Product Reference	ECE	Product Number	V	W					No.
64150ULT	H1	4008321416209	12	55	P14.5s	1	100	5 <sup>P.138</sup>	
64150ULT-01B	H1	Page 154	12	55	P14.5s	1	10	5 <sup>P.138</sup>	
64150ULT-HCB	H1	Page 154	12	55	P14.5s	2	20	5 <sup>P.138</sup>	
64193ULT	H4	4008321416230	12	60/55	P43t	1	100	8 <sup>P.138</sup>	
64193ULT-01B	H4	Page 154	12	60/55	P43t	1	10	8 <sup>P.138</sup>	
64193ULT-HCB	H4	Page 154	12	60/55	P43t	2	20	8 <sup>P.138</sup>	
64210ULT	H7	4008321416261	12	55	PX26d	1	100	9 <sup>P.138</sup>	
64210ULT-01B	H7	Page 154	12	55	PX26d	1	10	9 <sup>P.138</sup>	
64210ULT-HCB	H7	Page 154	12	55	PX26d	2	20	9 <sup>P.138</sup>	
64211ULT	H11	4052899431164	12	55	PGJ19-2	1	100	15 <sup>P.138</sup>	
64211ULT-01B	H11	Page 154	12	55	PGJ19-2	1	10	15 <sup>P.138</sup>	
64211ULT-HCB	H11	Page 154	12	55	PGJ19-2	2	20	15 <sup>P.138</sup>	
7506ULT	P21W	4008321415349	12	21	BA15s	10	50	38 <sup>P.138</sup>	
7506ULT-02B	P21W	Page 154	12	21	BA15s	2	20	38 <sup>P.138</sup>	
7507ULT <sup>1)</sup>	PY21W	4008321413147	12	21	BAU15s	10	50	38 <sup>P.138</sup>	
7507ULT-02B <sup>4)</sup>	PY21W	Page 154	12	21	BAU15s	2	20	38 <sup>P.138</sup>	
7528ULT	P21/5W	4008321413116	12	21/5	BAY15d	10	50	39 <sup>P.138</sup>	
7528ULT-02B	P21/5W	Page 154	12	21/5	BAY15d	2	20	39 <sup>P.138</sup>	
2825ULT	W5W	4008321413024	12	5	W2.1x9.5d	10	50	52 <sup>P.139</sup>	
2825ULT-02B	W5W	Page 154	12	5	W2.1x9.5d	2	20	52 <sup>P.139</sup>	
5007ULT	R5W	4008321415370	12	5	BA15s	10	50	48 <sup>P.139</sup>	
5007ULT-02B	R5W	Page 154	12	5	BA15s	2	20	48 <sup>P.139</sup>	
5008ULT	R10W	4008321415400	12	10	BA15s	10	50	48 <sup>P.139</sup>	
5008ULT-02B	R10W	Page 155	12	10	BA15s	2	20	48 <sup>P.139</sup>	
6418ULT	C5W	4008321413086	12	5	SV8.5-8	10	50	36 <sup>P.138</sup>	
6418ULT-02B	C5W	Page 155	12	5	SV8.5-8	2	20	36 <sup>P.138</sup>	
64132ULT	H6W	4008321413178	12	6	BAX9s	10	50	37 <sup>P.138</sup>	
64132ULT-02B	H6W	Page 155	12	6	BAX9s	2	20	37 <sup>P.138</sup>	
64137ULT <sup>4)</sup>	HY21W	4052899910256	12	21	BAW9s	10	50	35 <sup>P.138</sup>	

1) 4th year with online product registration. Refer to [www.osram.com/am-guarantee](http://www.osram.com/am-guarantee) for precise conditions and registration

2) Compared with standard lamps

3) With an average annual mileage of 14,259 km and 60% light on

4) Amber lamps for clear indicator lights

# OSRAM ORIGINAL LINE 12 V

## Original spare part

Convincing performance for standard requirements, robust and cost-effective:  
Successfully used in millions of new cars from renowned manufacturers, whether as standard initial equipment or original spare parts.



### Features

- OEM Quality
- Original spare parts that exceed all ECE minimum standards
- Wide product range

### Benefits

- Tried and trusted in millions of vehicles of well-known manufacturers
- Premium quality made in Germany
- Suitable for the most common applications

### OSRAM history

In 1925, OSRAM showcased the world a simple, yet ingenious solution – a lamp with two filaments, one for dipped beam and one for high beam. The BILUX® lamp was born and specifically registered to OSRAM. This enabled all the functions, which previously took up a lot of space and required complex mechanical designs, to be combined in one single light source. The lamp produced two beams with different strengths and angles in one single reflector.





Headlight manufacturers reacted quickly, and this technology became the typical light in all conventional vehicles in the 60s and even the 70s. It's still available today in its original form. The first generation of the OSRAM BILUX® lamps generally had a **P45t base** and an electrical output of **40/45 watts**.







**OSRAM ORIGINAL LINE 12 V headlight lamps / auxiliary lamps product range**

Product Reference	ECE	Product Number	V	W				
64150	H1	4050300001487	12	55	P14.5s	1	100	5 <sup>P.138</sup>
64150-01B	H1	Page 155	12	55	P14.5s	1	10	5 <sup>P.138</sup>
64173	H2	4050300016559	12	55	X511	1	100	6 <sup>P.138</sup>
64151	H3	4050300001554	12	55	PK22s	1	100	7 <sup>P.138</sup>
64151-01B	H3	Page 155	12	55	PK22s	1	10	7 <sup>P.138</sup>
64193	H4	4050300001470	12	60/55	P43t	1	100	8 <sup>P.138</sup>
64193-01B	H4	Page 155	12	60/55	P43t	1	10	8 <sup>P.138</sup>
64210	H7	4050300332185	12	55	PX26d	1	100	9 <sup>P.138</sup>
64210-01B	H7	Page 155	12	55	PX26d	1	10	9 <sup>P.138</sup>
64212	H8	4050300498751	12	35	PGJ19-1	1	100	10 <sup>P.138</sup>
64212-01B	H8	Page 155	12	35	PGJ19-1	1	10	10 <sup>P.138</sup>
64242 <sup>1)</sup>	H8B	4008321055422	12	35	PGJY19-1	1	100	11 <sup>P.138</sup>
64213	H9	4050300524368	12	65	PGJ19-5	1	100	12 <sup>P.138</sup>
64243 <sup>1)</sup>	H9B	4008321055477	12	65	PGJY19-5	1	100	13 <sup>P.138</sup>
9145	H10	4052899348622	12	42	PY20d	1	100	14 <sup>P.138</sup>
64211	H11	4050300524313	12	55	PGJ19-2	1	100	15 <sup>P.138</sup>
64211-01B	H11	Page 155	12	55	PGJ19-2	1	10	15 <sup>P.138</sup>
64241 <sup>1)</sup>	H11B	4008321054654	12	55	PGJY19-2	1	100	16 <sup>P.138</sup>
9008	H13	4008321939401	12	60/55	P26.4t	1	10	17 <sup>P.138</sup>
64176	H15	4008321218391	12	55/15	PGJ23t-1	1	100	18 <sup>P.138</sup>
64219L+	H16	4008321626783	12	19	PGJ19-3	1	100	19 <sup>P.138</sup>
64180L	H18	4052899479968	12	55	PY26d-1	1	100	20 <sup>P.138</sup>
64181L	H19	4052899599017	12	60/55	PU43t-3	1	100	21 <sup>P.138</sup>
880	H27W/1	4008321542977	12	27	PG13	1	100	32 <sup>P.138</sup>
881	H27W/2	4008321543004	12	27	PGJ13	1	100	32 <sup>P.138</sup>
9005	HB3	4050300137193	12	60	P20d	1	100	23 <sup>P.138</sup>
9005-01B	HB3	Page 155	12	60	P20d	1	10	23 <sup>P.138</sup>
9005XS	HB3A	4052899982567	12	60	P20d	1	100	24 <sup>P.138</sup>
9006	HB4	4050300012650	12	51	P22d	1	100	25 <sup>P.138</sup>
9006-01B	HB4	Page 155	12	51	P22d	1	10	25 <sup>P.138</sup>
9006XS	HB4A	4008321554284	12	51	P22d	1	100	26 <sup>P.138</sup>
9007	HB5	4050300148816	12	65/55	PX29t	1	200	27 <sup>P.138</sup>

**OSRAM ORIGINAL LINE 12 V headlight lamps / auxiliary lamps product range**

Product Reference	ECE	Product Number	V	W				 No.
9011	HIR1	400832 <b>1863966</b>	12	65	PX20d	1	100	28 <sup>P.138</sup>
9012	HIR2	400832 <b>1863997</b>	12	55	PX22d	1	100	28 <sup>P.138</sup>
7506	P21W	4050300 <b>838120</b>	12	21	BA15s	10	50	38 <sup>P.138</sup>
7506-02B	P21W	Page 155	12	21	BA15s	2	20	38 <sup>P.138</sup>
7507 <sup>2)</sup>	PY21W	4050300 <b>891477</b>	12	21	BAU15s	10	50	38 <sup>P.138</sup>
7507-02B <sup>2)</sup>	PY21W	Page 155	12	21	BAU15s	2	20	38 <sup>P.138</sup>
7225	P21/4W	4050300 <b>891514</b>	12	21/4	BAZ15d	10	50	39 <sup>P.138</sup>
7225-02B	P21/4W	Page 155	12	21/4	BAZ15d	2	20	39 <sup>P.138</sup>
7240	-	4050300 <b>838007</b>	12	21/5	BA15d	10	50	39 <sup>P.138</sup>
7528	P21/5W	4050300 <b>838069</b>	12	21/5	BAY15d	10	50	39 <sup>P.138</sup>
7528-02B	P21/5W	Page 155	12	21/5	BAY15d	2	20	39 <sup>P.138</sup>
3860	-	400832 <b>1095756</b>	12	5	BA9s	10	50	49 <sup>P.139</sup>
3893	T4W	4050300 <b>838489</b>	12	4	BA9s	10	50	49 <sup>P.139</sup>
3893-02B	T4W	Page 155	12	4	BA9s	2	20	49 <sup>P.139</sup>
2820	-	400832 <b>1094094</b>	12	2	W2.1x9.5d	10	50	51 <sup>P.139</sup>
2821	W3W	4050300 <b>838663</b>	12	3	W2.1x9.5d	10	50	51 <sup>P.139</sup>
2821-02B	W3W	Page 155	12	3	W2.1x9.5d	2	20	51 <sup>P.139</sup>
2825	W5W	4050300 <b>838632</b>	12	5	W2.1x9.5d	10	50	52 <sup>P.139</sup>
2825-02B	W5W	Page 155	12	5	W2.1x9.5d	2	20	52 <sup>P.139</sup>
2827NA <sup>2)</sup>	WY5W	4052899 <b>570795</b>	12	5	W2.1x9.5d	10	50	52 <sup>P.139</sup>
2827NA-02B <sup>2)</sup>	WY5W	Page 155	12	5	W2.1x9.5d	2	20	52 <sup>P.139</sup>
2886X	-	400832 <b>1094667</b>	12	6	W2.1x9.5d	10	50	52 <sup>P.139</sup>
921	W16W	400832 <b>1100948</b>	12	16	W2.1x9.5d	10	50	53 <sup>P.139</sup>
921-02B	W16W	Page 155	12	16	W2.1x9.5d	2	20	53 <sup>P.139</sup>
921NA <sup>2)</sup>	WY16W	4052899 <b>230460</b>	12	16	W2.1x9.5d	10	50	54 <sup>P.139</sup>
7504 <sup>2)</sup>	WY21W	400832 <b>1165473</b>	12	21	WX3x16d	10	50	55 <sup>P.139</sup>
7505	W21W	4052899 <b>324244</b>	12	21	W3x16d	10	50	55 <sup>P.139</sup>
7505-02B	W21W	Page 155	12	21	W3x16d	2	20	55 <sup>P.139</sup>
7515	W21/5W	4052899 <b>324312</b>	12	21/5	W3x16q	10	50	56 <sup>P.139</sup>
7515-02B	W21/5W	Page 155	12	21/5	W3x16q	2	20	56 <sup>P.139</sup>
2721	-	4050300 <b>838540</b>	12	1.2	W2x4.6d	10	50	58 <sup>P.139</sup>
2721-02B	-	Page 155	12	1.2	W2x4.6d	2	20	58 <sup>P.139</sup>
2722	-	400832 <b>1094803</b>	12	2	W2x4.6d	10	50	58 <sup>P.139</sup>
2722-02B	-	Page 155	12	2	W2x4.6d	2	20	58 <sup>P.139</sup>

## OSRAM ORIGINAL LINE 12 V headlight lamps / auxiliary lamps product range

Product Reference	ECE	Product Number	V	W				 No.
2723	W2.3W	4008321094834	12	2.3	W2x4.6d	10	50	50 <sup>P.139</sup>
64132	H6W	4008321094896	12	6	BAX9s	10	50	37 <sup>P.138</sup>
64136	H21W	4008321095190	12	21	BAY9s	10	50	34 <sup>P.138</sup>
5007	R5W	4050300838427	12	5	BA15s	10	50	48 <sup>P.139</sup>
5007-02B	R5W	Page 155	12	5	BA15s	2	20	48 <sup>P.139</sup>
5008	R10W	4050300838212	12	10	BA15s	10	50	48 <sup>P.139</sup>
5008-02B	R10W	Page 155	12	10	BA15s	2	20	48 <sup>P.139</sup>
5009 <sup>2)</sup>	RY10W	4008321095442	12	10	BAU15s	10	50	48 <sup>P.139</sup>
6411	-	4050300891354	12	10	SV8.5-8	10	50	61 <sup>P.139</sup>
6411-02B	-	Page 155	12	10	SV8.5-8	2	20	61 <sup>P.139</sup>
64111 <sup>3)</sup>	-	4008321095015	12	5	BA9s	10	50	65 <sup>P.139</sup>
64111-02B <sup>3)</sup>	-	Page 155	12	5	BA9s	2	20	65 <sup>P.139</sup>
64113	-	4008321095046	12	10	BA9s	10	50	65 <sup>P.139</sup>
64115	-	4008321095077	12	20	BA9s	10	50	65 <sup>P.139</sup>
6413	-	4050300891439	12	5	SV8.5-8	10	50	61 <sup>P.139</sup>
6418	C5W	4050300838397	12	5	SV8.5-8	10	50	36 <sup>P.138</sup>
6418-02B	C5W	Page 155	12	5	SV8.5-8	2	20	36 <sup>P.138</sup>
6428	-	4008321094384	12	3	SV7-8	10	50	62 <sup>P.139</sup>
6438	-	4008321094353	12	10	SV8.5-8	10	50	63 <sup>P.139</sup>
6438-02B	-	Page 155	12	10	SV8.5-8	2	20	63 <sup>P.139</sup>
6461	-	4008321094261	12	10	SV8.5-8	10	50	64 <sup>P.139</sup>
6486X	-	4008321094292	12	6	SV8.5-8	10	50	-
2351MFX6	-	4008321096852	12	1.2	BX8.4d	10	50	66 <sup>P.139</sup>
2352MFX6	-	4008321097149	12	2	BX8.4d	10	50	67 <sup>P.139</sup>
2452MFX6	-	4008321097118	12	1.5	BX8.4d	10	50	68 <sup>P.139</sup>
2473MFX6	-	4008321096821	12	1.12	BX8.4d	10	50	69 <sup>P.139</sup>
2721MFX	-	4008321297150	12	1.2	BX8.5d	10	50	71 <sup>P.139</sup>
2722MFX	-	4008321297181	12	2	BX8.5d	10	50	73 <sup>P.139</sup>
2721MF	-	4050300891255	12	1.2	B8.5d	10	50	70 <sup>P.139</sup>
2722MF	-	4008321096791	12	2	B8.5d	10	50	72 <sup>P.139</sup>
3156	P27W	4008321090621	12	27	W2.5x16d	10	50	40 <sup>P.138</sup>
3157	P27/7W	4052899183414	12	27/7	W2.5x16q	10	50	41 <sup>P.138</sup>
3757AK <sup>2)</sup>	PY27/7W	4052899178731	12	27/7	WX2.5x16q	10	50	42 <sup>P.138</sup>
3796	-	4050300891309	12	2	Ba9s	10	50	60 <sup>P.139</sup>
5201	PS19W	4052899600546	12	19	PG20-1	1	100	45 <sup>P.139</sup>
5202	PS24W	4052899600584	12	24	PG20-3	1	100	46 <sup>P.139</sup>
2504	PSX24W	4052899600560	12	24	PG20-7	1	100	47 <sup>P.139</sup>

1) Successor type for BILUX®-AS® lamp (product reference 7951)

2) Amber lamps for clear indicator lights

3) Also available with glass base (product reference 6411150 or 6411350)

The suffix on the product reference indicates the board thickness:

MF6: 1.5mm

MF: 2.0mm

MF6: 1.5mm

# OSRAM MINIBOX

## Mobile lamp replacement

Defects in a vehicle usually make themselves known on long journeys. The OSRAM MINIBOX saves you the trouble of searching for a suitable workshop to purchase replacement lamps. You can therefore easily fix the problem yourself.



### Features

- Range of most important spare lamps
- Clear labeling and application illustration
- Reserve light for cars
- Original spare parts that exceed all ECE minimum standards

### Benefits

- You'll always have the right spare lamps at hand
- Easy identification
- Mandatory in many countries
- Premium quality made in Germany



**OSRAM MINIBOX product range**



**H1 ORIGINAL box**

The H1 box is equipped with one H1 headlight lamp and contains the following five most important spare lamps and three flat fuses.

**H4 ORIGINAL box**

The H4 box is equipped with one H4 headlight lamp and contains the following five most important spare lamps and three flat fuses.

**H7 ORIGINAL box**

The H7 box is equipped with one H7 headlight lamp and contains the following five most important spare lamps and three flat fuses.

**H1/H7 ORIGINAL box**

The H1/H7 box is equipped with one H1 and one H7 headlight lamp and contains the following five most important spare lamps and three flat fuses.

	Product Number	Product Reference	ECE	i
H1 box	4050300875217	CLK H1	H1	Headlight + five spare lamps and three flat fuses
H4 box	4050300873398	CLK H4	H4	Headlight + five spare lamps and three flat fuses
H7 box	4050300876375	CLK H7	H7	Headlight + five spare lamps and three flat fuses
H1/H7 box	4052899522640	CLK H1/H7	H1/H7	Headlights + five spare lamps and three flat fuses
All boxes	7506		P21W	Brake and tail light
	7507		PY21W	Indicator light, amber
	7528		P21/5W	Brake/tail light
	5007		R5W	Tail light and license plate light
	2825		W5W	Parking light
				15A, 20A, 30A flat fuses



## Halogen lamps for buses and trucks – extreme durability, extreme high-performance

Truck and commercial vehicle lamps in daily use are often pushed to their performance limit. Lighting systems must therefore be enormously durable and extremely reliable – only then can they provide perfect light until the end of each run. The extremely long life of OSRAM high performance solutions enhances driving comfort and reduces maintenance time and fleet costs.

Vehicle drivers and fleet managers can choose from a wide range of high performance truck lamps at OSRAM. All lighting solutions not only meet the highest quality requirements and offer OEM quality, but also exceed even European standards.

# OSRAM TRUCKSTAR® PRO

## Brightest OSRAM truck light

Up to 100% more brightness compared to the minimum legal standard, extra lifetime and very high vibration resistance are ideal for professional drivers while reducing downtime and fleet costs.



### Features

- Up to 100% more brightness<sup>1)</sup>
- More than double the service life<sup>2)</sup>
- Very high vibration resistance

### Benefits

- More light allows to see farther and therefore react sooner
- Reduced downtime and fleet costs
- Suitable for heavy duty applications

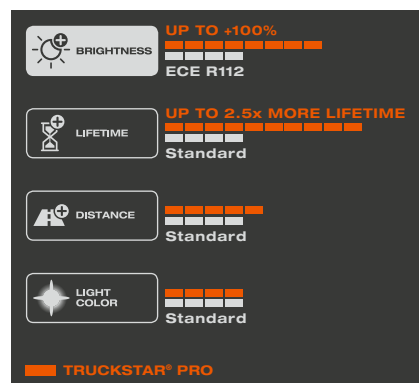



**OSRAM TRUCKSTAR® PRO product range**

Product Reference	ECE	Product Number	V	W					No.
64155TSP	H1	4008321784179	24	70	P14.5s	1	100	5 <sup>P.138</sup>	
64155TSP-HCB	H1	Page 155	24	70	P14.5s	2	20	5 <sup>P.138</sup>	
64156TSP	H3	4008321784261	24	70	PK22s	1	100	7 <sup>P.138</sup>	
64156TSP-01B	H3	Page 155	24	70	PK22s	1	10	7 <sup>P.138</sup>	
64156TSP-HCB	H3	Page 155	24	70	PK22s	2	20	7 <sup>P.138</sup>	
64196TSP	H4	4008321785046	24	75/70	P43t	1	100	8 <sup>P.138</sup>	
64196TSP-HCB	H4	Page 155	24	75/70	P43t	2	20	8 <sup>P.138</sup>	
64215TSP	H7	4008321785114	24	70	PX26d	1	100	9 <sup>P.138</sup>	
64215TSP-HCB	H7	Page 155	24	70	PX26d	2	20	9 <sup>P.138</sup>	
64216TSP	H11	4052899904804	24	70	PGJ19-2	1	100	15 <sup>P.138</sup>	
64216TSP-HCB	H11	Page 155	24	70	PGJ19-2	2	20	15 <sup>P.138</sup>	
7510TSP <sup>3)</sup>	PY21W	4008321798169	24	21	BAU15s	10	50	38 <sup>P.138</sup>	
7511TSP	P21W	4052899340459	24	21	BA15s	10	50	38 <sup>P.138</sup>	
7537TSP	P21/5W	4008321798138	24	21/5	BAY15d	10	50	39 <sup>P.138</sup>	
2845TSP	W5W	4008321798077	24	5	W2.1x9.5d	10	50	52 <sup>P.139</sup>	
5627TSP	R5W	4008321795151	24	5	BA15s	10	50	48 <sup>P.139</sup>	
5637TSP	R10W	4008321795205	24	10	BA15s	10	50	48 <sup>P.139</sup>	
3930TSP	T4W	4008321795106	24	4	BA9s	10	50	49 <sup>P.139</sup>	
3930TSP-02B	T4W	Page 155	24	4	BA9s	2	20	49 <sup>P.139</sup>	

1) Compared to minimum ECE R112 requirements  
 2) Compared with standard lamps  
 3) Amber lamps for clear indicator lights

# OSRAM ORIGINAL LINE 24 V

## Original spare part for trucks

A balanced and economic solution for all standard requirements in the 24 V sector. Successfully used in millions of new vehicles from renowned manufacturers, whether as standard initial equipment or original spare parts.



### Features

- OEM Quality
- Original spare parts that exceed all ECE minimum standards
- Wide product range

### Benefits

- Tried and trusted in millions of vehicles of well-known manufacturers
- Premium quality made in Europe
- Suitable for the most common applications

---

The suffix on the product reference indicates the board thickness:

MF: 2.0 mm

MFX: 1.5 mm



**OSRAM ORIGINAL LINE 24 V headlight lamps / auxiliary lamps product range**

Product Reference	ECE	Product Number	V	W					No.
64155	H1	4050300016498	24	70	P14.5s	1	100	5 <sup>P.138</sup>	
64155-01B	H1	Page 156	24	70	P14.5s	1	10	5 <sup>P.138</sup>	
64175	H2	4050300218960	24	70	X511	1	100	6 <sup>P.138</sup>	
64156	H3	4050300016535	24	70	PK22s	1	100	7 <sup>P.138</sup>	
64156-01B	H3	Page 156	24	70	PK22s	1	10	7 <sup>P.138</sup>	
64196	H4	4050300016542	24	75/70	P43t	1	100	8 <sup>P.138</sup>	
64196-01B	H4	Page 156	24	75/70	P43t	1	10	8 <sup>P.138</sup>	
94196	H4	4050300250632	24	75/70	P43t	1	100	8 <sup>P.138</sup>	
64215	H7	4050300386522	24	70	PX26d	1	100	9 <sup>P.138</sup>	
64215-01B	H7	Page 156	24	70	PX26d	1	10	9 <sup>P.138</sup>	
64177	H15	4008321536556	24	20/60	PGJ23t-1	1	100	18 <sup>P.138</sup>	
7511	P21W	4050300838090	24	21	BA15s	10	50	38 <sup>P.138</sup>	
7511-02B	P21W	Page 156	24	21	BA15s	2	20	38 <sup>P.138</sup>	
7537	P21/5W	4050300838038	24	21/5	BAY15d	10	50	39 <sup>P.138</sup>	
7537-02B	P21/5W	Page 156	24	21/5	BAY15d	2	20	39 <sup>P.138</sup>	
7529	-	4050300891774	24	15	BA15s	10	50	38 <sup>P.138</sup>	
5626	R5W	4008321095336	24	5	BA15d	10	50	48 <sup>P.139</sup>	
5627	R5W	4050300838335	24	5	BA15s	10	50	48 <sup>P.139</sup>	
5627-02B	R5W	Page 156	24	5	BA15s	2	20	48 <sup>P.139</sup>	
5637	R10W	4050300831459	24	10	BA15s	10	50	48 <sup>P.139</sup>	
5637-02B	R10W	Page 156	24	10	BA15s	2	20	48 <sup>P.139</sup>	
3797	-	4050300891668	24	2	BA9s	10	50	49 <sup>P.139</sup>	
3930	T4W	4050300838366	24	4	BA9s	10	50	49 <sup>P.139</sup>	
3930-02B	T4W	Page 156	24	4	BA9s	2	20	49 <sup>P.139</sup>	
64138	H21W	4008321094988	24	21	BAY9s	10	50	34 <sup>P.139</sup>	
2341	-	4008321132529	24	1	W2x4.6d	10	50	57 <sup>P.139</sup>	
2840	-	4008321094698	24	2	W2.1x9.5d	10	50	59 <sup>P.139</sup>	
2841	W3W	4008321094728	24	3	W2.1x9.5d	10	50	51 <sup>P.139</sup>	
2841-02B	W3W	Page 156	24	3	W2.1x9.5d	2	20	51 <sup>P.139</sup>	
2845	W5W	4050300891552	24	5	W2.1x9.5d	10	50	52 <sup>P.139</sup>	
2845-02B	W5W	Page 156	24	5	W2.1x9.5d	2	20	52 <sup>P.139</sup>	
2741	-	4050300838519	24	1.2	W2x4.6d	10	50	58 <sup>P.139</sup>	
6421	-	4008321090768	24	3	SV8.5-8	10	50	61 <sup>P.139</sup>	
6423	C5W	4050300831435	24	5	SV8.5-8	10	50	36 <sup>P.138</sup>	
6423-02B	C5W	Page 156	24	5	SV8.5-8	2	20	36 <sup>P.138</sup>	
6424	-	4050300891712	24	5	SV8.5-8	10	50	61 <sup>P.139</sup>	
6429	-	4008321090836	24	10	SV8.5-8	10	50	61 <sup>P.139</sup>	
6430	-	4008321094414	24	3	SV8.5-8	10	50	62 <sup>P.139</sup>	
2741MF	-	4050300891606	24	1.2	B8.5d	10	50	74 <sup>P.139</sup>	
2741MFX	-	4008321297211	24	1.2	BX8.5d	10	50	74 <sup>P.139</sup>	

# OSRAM spare lamp kit 24 V

## Reserve light for trucks and buses

Professional truck drivers in particular rely on spare lamp kits from OSRAM. They can be used to repair faults without assistance or major work, wherever required.



### Features

- Range of most important spare lamps
- Clear labeling and application illustration
- Original spare parts that exceed all ECE minimum standards

### Benefits

- You'll always have the right spare lamps at hand
- Easy identification
- Premium quality made in Germany



**OSRAM spare lamp box, 24 V product range**

**H7 TRUCKSTAR® PRO box**

The TRUCKSTAR® PRO box is equipped with two H7 TRUCKSTAR® PRO headlight lamps and contains the following double sets of the six most important spare lamps and three flat fuses.

**Product Number:** 4008321809063

**Product Reference** ECE i

64215TSP	H7	Headlight
7511TSP	P21W	Brake and tail light
7510TSP	PY21W	Indicator light, amber
7537TSP	P21/5W	Brake/tail light
5627TSP	R5W	Tail light and license plate light
5637TSP	R10W	Parking light
3930TSP	T4W	Park and position light
		15A, 20A, 30A flat fuses

**H4 ORIGINAL box**

The H4 box is equipped with two H4 headlight lamps and contains the following double sets of the six most important spare lamps and three flat fuses.

**Product Number:** 4008321583192

**Product Reference** ECE i

64196	H4	Headlight
7511	P21W	Brake and tail light
7510TSP	PY21W	Indicator light, amber
7537	P21/5W	Brake/tail light
5627	R5W	Tail light and license plate light
5637	R10W	Parking light
3930	T4W	Park and position light
		15A, 20A, 30A flat fuses

**H7 ORIGINAL box**

The H7 box is equipped with two H7 headlight lamps and contains the following double sets of the six most important spare lamps and three flat fuses.

**Product Number:** 4008321583215

**Product Reference** ECE i

64215	H7	Headlight
7511	P21W	Brake and tail light
7510TSP	PY21W	Indicator light, amber
7537	P21/5W	Brake/tail light
5627	R5W	Tail light and license plate light
5637	R10W	Parking light
3930	T4W	Park and position light
		15A, 20A, 30A flat fuses





# Halogen lamps for motorcycles and scooters – safety first

Motorcycles, mopeds, or scooters are all too often overlooked in traffic – especially at night. The right lighting can save lives. Drivers of motorized two-wheelers value OSRAM motorcycle lamps for their high performance and high vibration resistance proven in tests. OSRAM halogen headlight lamps optimize illumination on the roads and provide more reaction time in the event of an emergency. Alongside increased safety, OSRAM offers bikers with motorcycle lamps a wide variety of customization options from the design, performance, and original portfolio.



# OSRAM motorcycle lamps

## Vibration-resistant technology

Power and emotion, for relaxed cruisers and sportive riders: With NIGHT RACER® 110, NIGHT RACER® 90, NIGHT RACER® 50, X-RACER® and ORIGINAL, OSRAM offers a wide range of high performance motorcycle lamps – opening a new dimension for life on two wheels.



### Features of

#### NIGHT RACER® 110

- Up to 110% more brightness<sup>1)</sup>
- Up to 40 m longer beam<sup>2)</sup>
- Up to 20% whiter light<sup>1)</sup>
- Vibration-resistant technology
- Partial blue coating and silver cap

### Features of

#### NIGHT RACER® 90

- Up to 90% more brightness<sup>1)</sup>
- Up to 30 m longer beam<sup>2)</sup>
- Up to 10% whiter light<sup>1)</sup>
- Vibration-resistant technology
- Partial blue coating and silver cap

### Benefits of NIGHT RACER® 110 / NIGHT RACER® 90

- More light allows to see farther and therefore react sooner
- Better visibility
- Modern look
- Tested for resilience with speed and changing road surfaces
- Eye-catching design

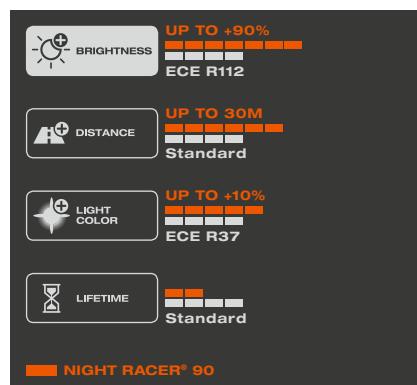
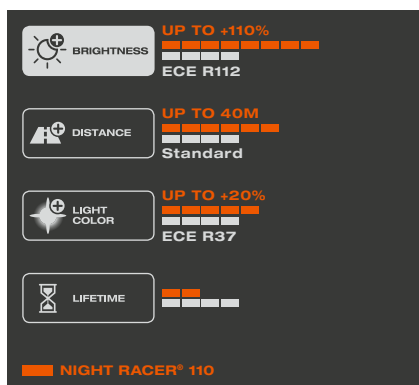



**OSRAM NIGHT RACER® 110 product range**

Product Reference	ECE	Product Number	V	W				
64193NR1-01B	H4	Page 155	12	60/55	P43t	1	10	8 <sup>P.138</sup>
64193NR1-02B	H4	4052899 <b>929678</b>	12	60/55	P43t	2	20	8 <sup>P.138</sup>
64210NR1-01B	H7	Page 155	12	55	PX26d	1	10	9 <sup>P.138</sup>
64210NR1-02B	H7	4052899 <b>929616</b>	12	55	PX26d	2	20	9 <sup>P.138</sup>
64212NR1-01B	H8	Page 155	12	35	PGJ19-1	2	20	10 <sup>P.138</sup>
64211NR1-01B	H11	Page 155	12	55	PGJ19-2	1	10	15 <sup>P.138</sup>

**OSRAM NIGHT RACER® 90 product range**

Product Reference	ECE	Product Number	V	W				
64185NR9-01B	HS1	Page 155	12	35/35	PX43t	1	10	30 <sup>P.138</sup>

1) Compared to minimum ECE R112/R37 requirements  
 2) Compared with standard lamps



**Features of NIGHT RACER® 50**

- Up to 50% more brightness<sup>1)</sup>
- Up to 20 m longer beam<sup>2)</sup>
- Vibration-resistant technology
- Modern design with silver cap
- Excellent performance-lifetime ratio

**Benefits of NIGHT RACER® 50**

- More light allows to see farther and therefore react sooner
- Better visibility
- Tested for resilience with speed and changing road surfaces
- Ideal for use in clear-glass headlights
- More light at a reasonable lifetime

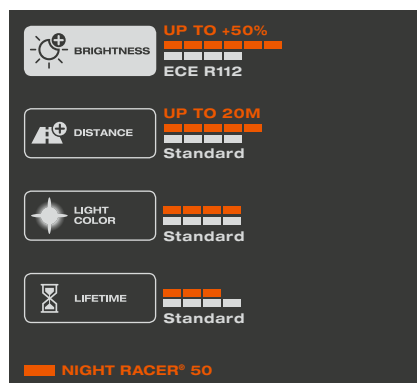



### OSRAM NIGHT RACER® 50 product range

Product Reference	ECE	Product Number	V	W				
64193NR5-01B	H4	Page 155	12	60/55	P43t	1	10	8 <sup>P.138</sup>
64210NR5-01B	H7	Page 155	12	55	PX26d	1	10	9 <sup>P.138</sup>
64211NR5-01B	H11	Page 155	12	55	PGJ19-2	1	10	15 <sup>P.138</sup>
64185NR5	HS1	4052899 <b>933002</b>	12	35/35	PX43t	1	10	30 <sup>P.138</sup>
64185NR5-01B	HS1	Page 155	12	35/35	PX43t	1	10	30 <sup>P.138</sup>

1) Compared to minimum ECE R112 requirements

2) Compared with standard lamps



**Features of X-RACER®**

- Bluish-white light for xenon look
- Color temperatures of up to 4,200 K
- Up to 20% more brightness<sup>1)</sup>
- Vibration-resistant technology
- Modern design with silver cap

**Benefits of X-RACER®**

- Modern and stylish look
- High contrast
- More light allows to see farther and therefore react sooner
- Tested for resilience with speed and changing road surfaces
- Ideal for use in clear-glass headlights

**Features of ORIGINAL**

- OEM Quality
- Original spare parts that exceed all ECE minimum standards
- Wide product range

**Benefits of ORIGINAL**

- Tried and trusted in millions of vehicles of well-known manufacturers
- Premium quality
- Suitable for the most common headlights

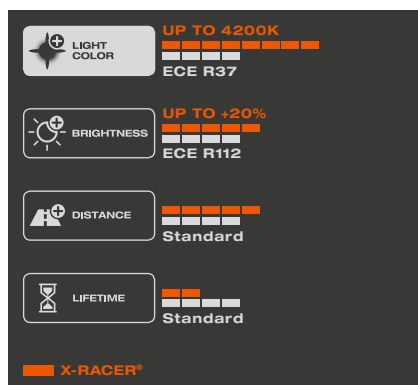





### OSRAM X-RACER® product range

Product Reference	ECE	Product Number	V	W				
								No.
64193XR-01B	H4	Page 155	12	60/55	P43t	1	20	8 <sup>P.138</sup>
64193XR-02B	H4	4052899 <b>929630</b>	12	60/55	P43t	2	20	8 <sup>P.138</sup>
64210XR-01B	H7	Page 155	12	55	PX26d	1	20	9 <sup>P.138</sup>
64210XR-02B	H7	4052899 <b>929579</b>	12	55	PX26d	2	20	9 <sup>P.138</sup>
64212XR-01B	H8	Page 155	12	35	PGJ19-1	1	10	10 <sup>P.138</sup>
64211XR-01B	H11	Page 155	12	55	PGJ19-2	1	10	15 <sup>P.138</sup>
64185XR-01B	HS1	Page 155	12	35/35	PX43t	1	10	30 <sup>P.138</sup>
64327XR-01B	S2	Page 155	12	35/35	BA20d	1	10	33 <sup>P.138</sup>

### OSRAM ORIGINAL product range

Product Reference	ECE	Product Number	V	W				
								No.
64193MC	H4	4052899 <b>451353</b>	12	60/55	P43t	1	20	8 <sup>P.138</sup>
64210MC	H7	4052899 <b>451384</b>	12	55	PX26d	1	20	9 <sup>P.138</sup>
64326	S1	4052899 <b>157774</b>	12	25/25	BA20d	1	100	33 <sup>P.138</sup>
64327	S2	4052899 <b>136755</b>	12	35/35	BA20d	1	100	33 <sup>P.138</sup>
64327-01B	S2	Page 155	12	35/35	BA20d	1	10	33 <sup>P.138</sup>
64183	R2	4050300 <b>350554</b>	12	45/40	P45t	1	100	31 <sup>P.138</sup>
64183-01B	R2	Page 155	12	45/40	P45t	1	10	31 <sup>P.138</sup>
64185	HS1	4050300 <b>439969</b>	12	35/35	PX43t	1	100	30 <sup>P.138</sup>
64185-01B	HS1	Page 155	12	35/35	PX43t	1	10	30 <sup>P.138</sup>

1) Compared to minimum ECE R112 requirements

## Lamps for off-road use – best light, even off-road<sup>1)</sup>

Whether for competitions and races, construction and transport work, agriculture and forestry, or an enthusiast off-roader, driving off-road demands everything of lighting systems. Thanks to many years of experience in off-road driving, OSRAM knows exactly what these drivers want. In addition to robustness, resistance, and stability, above all they want outstanding and reliable lighting performance. The answer is a strong OSRAM product range of off-road lamps with high wattage that impress with excellent brightness and high color temperature in absolutely any environment.



<sup>1)</sup> These products do not have ECE approval. This means they must not be used on public roads in any exterior application. Use on public roads leads to cancellation of operating license and loss of insurance coverage. Several countries do not allow sale and use of these products. Please contact your local distributor for information on the availability in your country.



# SUPER BRIGHT PREMIUM / SUPER BRIGHT

## Extra power for off-road use

With a strong portfolio of high-wattage off-road lamps with extra power, OSRAM provides solutions for even the most unusual requirements. All lamps are designed and designated for off-road use only and not permitted on public roads<sup>1)</sup>.



### Features<sup>1)</sup>

- Extra power due to high wattage
- Excellent brightness
- Rugged and versatile

### Benefits<sup>1)</sup>

- For the most difficult terrain: rescue services, construction and transport work, agriculture and forestry
- More light allows to see farther and therefore react sooner
- Solution for even the most unusual requirements

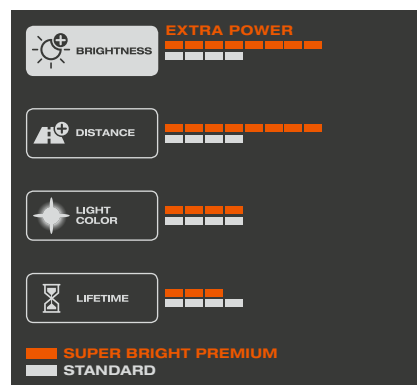



### OSRAM SUPER BRIGHT PREMIUM / SUPER BRIGHT high-performance headlamps<sup>1)</sup> – product range

Product Reference		Product Number	V	W				No.
62200SBP	P14.5s (H1)	4052899 <b>126282</b>	12	100	1	100		5 <sup>P.138</sup>
62201SBP	PK22s (H3)	4052899 <b>126312</b>	12	100	1	100		7 <sup>P.138</sup>
62204SBP	P43t (H4)	400832 <b>1856357</b>	12	100/90	1	100		8 <sup>P.138</sup>
62261SBP	PX26d (H7)	400832 <b>1856388</b>	12	80	1	100		9 <sup>P.138</sup>
69005SBP	P20d (HB3)	400832 <b>1888174</b>	12	100	1	100		23 <sup>P.138</sup>
69006SBP	P22d (HB4)	400832 <b>1888228</b>	12	80	1	100		25 <sup>P.138</sup>
64152SB	PX14.5s	4050300 <b>222738</b>	12	100	1	100		5 <sup>P.138</sup>
64153SB	PKY22s	4050300 <b>222837</b>	12	100	1	100		7 <sup>P.138</sup>
64194SB	PU43t	4050300 <b>225852</b>	12	100/90	1	100		8 <sup>P.138</sup>
64204SB	P45t (R2)	4052899 <b>931565</b>	12	100/90	1	100		31 <sup>P.138</sup>
64198SB	P45t (R2)	4050300 <b>222028</b>	12	60/55	1	100		31 <sup>P.138</sup>

1) These products do not have ECE approval. This means they must not be used on public roads in any exterior application. Use on public roads leads to cancellation of operating license and loss of insurance coverage. Several countries do not allow sale and use of these products. Please contact your local distributor for information on the availability in your country.

# XENARC® COOL BLUE® BOOST / COOL BLUE® BOOST

## Hyper blue light for off-road use

The COOL BLUE® BOOST and XENARC® COOL BLUE® BOOST product families convince with hyper blue light and high color temperatures. All lamps are designed and designated for off-road use only and not permitted on public roads<sup>1)</sup>.



### Features of

#### XENARC® COOL BLUE® BOOST<sup>1)</sup>

- Hyper blue light due to a special filling system used instead of conventional coating
- Color temperatures of up to 7,000 K
- Enhanced brightness

### Features of

#### COOL BLUE® BOOST<sup>1)</sup>

- Hyper blue light
- Color temperatures of up to 5,000 K
- Up to 50% more light<sup>2)</sup>

### Benefits of

#### XENARC® COOL BLUE® BOOST<sup>1)</sup> / COOL BLUE® BOOST<sup>1)</sup>

- Modern look
- High contrast
- More light allows to see farther and therefore react sooner

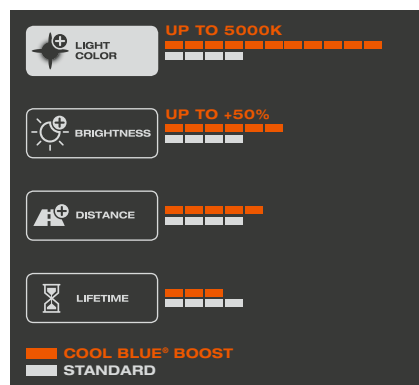
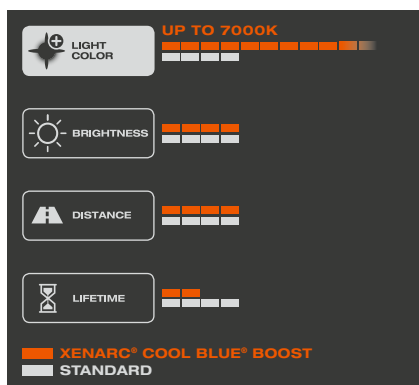



### OSRAM XENARC® COOL BLUE® BOOST high-performance headlamps<sup>1)</sup> – product range

Product Reference		Product Number	V	W				No.
66140CBB-HCB	PK32d-2 (D1S)	Page 154	12/24	35	2	10		1 <sup>P.138</sup>
66240CBB-HCB	P32d-2 (D2S)	Page 154	12/24	35	2	10		3 <sup>P.138</sup>
66340CBB-HCB	PK32d-5 (D3S)	Page 154	12/24	35	2	10		1 <sup>P.138</sup>
66440CBB-HCB	P32d-5 (D4S)	Page 154	12/24	35	2	10		3 <sup>P.138</sup>

### OSRAM COOL BLUE® BOOST high-performance headlamps<sup>1)</sup> – product range

Product Reference		Product Number	V	W				No.
62150CBB-HCB	P14.5s (H1)	Page 156	12	80	2	20		5 <sup>P.138</sup>
62193CBB-HCB	P43t (H4)	Page 156	12	100/90	2	20		8 <sup>P.138</sup>
62210CBB-HCB	PX26d (H7)	Page 156	12	80	2	20		9 <sup>P.138</sup>
62213CBB-HCB	PGJ19-5 (H9)	Page 156	12	75	2	20		12 <sup>P.138</sup>
62211CBB-HCB	PGJ19-2 (H11)	Page 156	12	80	2	20		15 <sup>P.138</sup>
69005CBB-HCB	P20d (HB3/HB3A)	Page 156	12	100	2	20		23/24 <sup>P.138</sup>
69006CBB-HCB	P22d (HB4/HB4A)	Page 156	12	80	2	20		25/26 <sup>P.138</sup>

1) These products do not have ECE approval. This means they must not be used on public roads in any exterior application. Use on public roads leads to cancellation of operating license and loss of insurance coverage. Several countries do not allow sale and use of these products. Please contact your local distributor for information on the availability in your country.

2) Compared with other blue coated halogen lamps

# LED fixtures for a strong look

OSRAM offers a variety of automotive fixtures like LED headlights, driving and working lights, daytime running lights and fog lights to upgrade certain vehicles with state-of-the-art technology for a modern look.





# LEDDriving<sup>®</sup> headlight

## Full LED redesign made easy – and legal

The OSRAM LEDDriving<sup>®</sup> headlights for VW Golf VII offer a legal performance and outstanding design upgrade for halogen-based or high intense discharge (HID)-based VW Golf VII models. All the lighting functions feature state-of-the-art LED technology: low beam, high beam, daytime running, position and turn indicator lights. Road safety also plays a major role.





### Features

- Up to 200% more light<sup>1)</sup>
- Up to 200 m long light beam
- Up to 100% whiter light<sup>2)</sup>
- Premium OSRAM quality available as GTI, BLACK and CHROME edition
- Full LED, ECE certified with long lifetime



### Benefits

- More light allows to see farther and therefore react faster thanks to pixel-free optic and state-of-the-art lightguide technology
- Better visibility due to daylight effect with easy plug & play installation without modifying or damaging existing cables
- High contrast and brilliantly cool white LED light for most stylish look on the road
- 2-year guarantee<sup>3)</sup>
- No additional beam level adjustment and headlight cleaning system required, as well as no additional parts and no registration needed for installation

**OSRAM LEDriving® headlights for VW Golf VII as halogen replacement – product range**

Product Reference	Product Number	V	W	K	L [mm]	W [mm]	h [mm]			 No.
LEDHL103-GTI <sup>4)5)</sup>	4052899 <b>599628</b>	12	-	6500	630	400	240	1	1	2 <sup>P.135</sup>
LEDHL103-CM <sup>4)5)</sup>	4052899 <b>599611</b>	12	-	6500	630	400	240	1	1	2 <sup>P.135</sup>
LEDHL103-BK <sup>4)5)</sup>	4052899 <b>599598</b>	12	-	6500	630	400	240	1	1	2 <sup>P.135</sup>

**OSRAM LEDriving® headlights for VW Golf VII as xenon replacement – product range**

Product Reference	Product Number	V	W	K	L [mm]	W [mm]	h [mm]			 No.
LEDHL104-GTI <sup>4)5)</sup>	4052899 <b>604933</b>	12	-	6500	630	400	240	1	1	2 <sup>P.135</sup>
LEDHL104-CM <sup>4)5)</sup>	4052899 <b>604919</b>	12	-	6500	630	400	240	1	1	2 <sup>P.135</sup>
LEDHL104-BK <sup>4)5)</sup>	4052899 <b>604896</b>	12	-	6500	630	400	240	1	1	2 <sup>P.135</sup>



Daytime Running Light



Position Light and Low Beam



Position Light and High Beam



Position Light and Signal Light

- 1) Compared to minimum ECE R112 requirements
- 2) When compared with standard headlights with halogen lamp
- 3) Refer to [www.osram.com/am-guarantee](http://www.osram.com/am-guarantee) for precise conditions
- 4) Not suitable for left-hand traffic
- 5) Only suitable for VW Golf VII car models with OEM halogen or OEM xenon-headlights with halogen daytime running light

# LEDDriving® XENARC® headlight

## Redesign made easy – and legal

With its outstanding design, the LEDDriving® XENARC® headlight combines modern LED daytime running light functionality with a powerful xenon lamp. With this headlight, OSRAM offers a solution for all VW Golf VI and Ford Focus 3 models not equipped with xenon headlights. Upgrading to the ECE-approved LEDDriving® XENARC® headlight complies with all legal requirements – no need to fit automatic leveling or a headlight-cleaning system.



### Features of LEDDriving® XENARC® headlight for VW Golf VI

- Up to 70% more light<sup>1)</sup>
- Up to 180 m long light beam
- Up to 40% whiter light<sup>2)</sup>
- Premium OSRAM quality available as GTI, BLACK and CHROME edition
- ECE certified with extra lifetime

### Features of LEDDriving® XENARC® headlight for Ford Focus 3

- Up to 70% more light<sup>1)</sup>
- Up to 180 m long light beam
- Up to 40% whiter light<sup>2)</sup>
- Premium OSRAM quality
- ECE certified with extra lifetime

### Benefits of LEDDriving® XENARC® headlight for VW Golf VI and for Ford Focus 3

- More light allows to see farther and therefore react sooner thanks to pixel-free optic and state-of-the-art lightguide technology
- Better visibility due to daylight effect with easy plug & play installation without modifying or damaging existing cables
- High contrast and brilliantly cool white LED light for the most stylish look on the road
- 2-year guarantee<sup>3)</sup>
- No additional beam level adjustment and headlight cleaning system required, as well as no additional parts and no registration needed for installation

**OSRAM LEDriving® XENARC® headlight for Ford Focus 3 – product range**

Product Reference	Product Number	V	W	K	l [mm]	w [mm]	h [mm]			No.
LEDHL105 <sup>4)5)</sup>	4052899 <b>600997</b>	12	70	6000	690	400	200	1	1	3 <sup>P.135</sup>



Daytime Running Light



Position Light and Low Beam



Position Light and High Beam



Position Light and Signal Light

**OSRAM LEDriving® XENARC® headlight for VW Golf VI – product range**

Product Reference	Product Number	V	W	K	l [mm]	w [mm]	h [mm]			No.
LEDHL102-GT <sup>4)5)</sup>	4052899 <b>982161</b>	12	70	-	410	450	200	1	1	1 <sup>P.135</sup>
LEDHL102-CM <sup>4)5)</sup>	4052899 <b>982147</b>	12	70	-	410	450	200	1	1	1 <sup>P.135</sup>
LEDHL102-BK <sup>4)5)</sup>	4052899 <b>982123</b>	12	70	-	410	450	200	1	1	1 <sup>P.135</sup>
LEDHL102-BK RHD <sup>5)6)</sup>	4052899 <b>519404</b>	12	70	-	410	450	200	1	1	1 <sup>P.135</sup>



Daytime Running Light



Position Light and Low Beam



Position Light and High Beam



Position Light and Signal Light (Dynamic/Static)

- 1) Compared to minimum ECE R112 requirements
- 2) When compared with standard headlights with halogen lamp
- 3) Refer to [www.osram.com/am-guarantee](http://www.osram.com/am-guarantee) for precise conditions
- 4) Not suitable for left-hand traffic
- 5) Only suitable for VW Golf VI and Ford Focus 3 cars with OEM halogen headlight
- 6) Suitable for left-hand traffic



## LEDDriving<sup>®</sup> dynamic mirror indicator

### Unique design meets innovative lighting technology

OSRAM has upgraded its extensive LED portfolio with dynamic side turn indicators. The new products are available in white and black versions. Thanks to plug & play technology, the LED turn indicators are quick and easy to install. The products are approved for road use without having to be registered (ECE certified according to ECE R6/R10).

#### Features

- Fully dynamic LED mirror turn signal with OSRAM LEDs
- Up to 200% more brightness<sup>1)</sup>
- Easy plug & play installation
- Premium OSRAM quality available as BLACK and WHITE edition
- ECE certified upgrade to ECE R6/R10

#### Benefits

- Uniform light distribution for improved perception in oncoming traffic thanks to state-of-the-art fibre-optic technology
- Additional viewing window on the driver's side for quick detection of the flashing function
- High contrast day and night due to intensive yellow LED light<sup>2)</sup>
- Simple plug-and-play installation without altering or damaging existing cables
- 5-years warranty<sup>3)</sup>



**OSRAM LEDDriving® Dynamic Mirror Indicator for VW Golf VII – product range**

Product Reference	Product Number	V	W	K	l (mm)	w (mm)	h (mm)			No.
LEDDMI 5G0 WT S <sup>4)</sup>	4062172046534	12	2.4	2700	280	70	50	1	4	4 <sup>P.135</sup>
LEDDMI 5G0 BK S <sup>4)</sup>	4062172046510	12	2.4	2700	280	70	50	1	4	4 <sup>P.135</sup>

**OSRAM LEDDriving® Dynamic Mirror Indicator for VW Passat B8 – product range**

Product Reference	Product Number	V	W	K	l (mm)	w (mm)	h (mm)			No.
LEDDMI 3G0 WT S <sup>5)</sup>	4062172046497	12	2.4	2700	255	65	57	1	4	5 <sup>P.135</sup>

**OSRAM LEDDriving® Dynamic Mirror Indicator for BMW F20 – product range**

Product Reference	Product Number	V	W	K	l (mm)	w (mm)	h (mm)			No.
LEDDMI F20 WT S <sup>6)</sup>	4062172051286	12	4.56	2700	220	55	74	1	4	6 <sup>P.135</sup>
LEDDMI F20 BK S <sup>6)</sup>	4062172052795	12	4.56	2700	220	55	74	1	4	6 <sup>P.135</sup>



**Check the compatibility of your car!**  
 Vehicle Finder: [https://www.osram.com/am/dmi\\_vehiclefinder.jsp](https://www.osram.com/am/dmi_vehiclefinder.jsp)



- 1) Compared to the minimum ECE R6 requirements
- 2) In comparison to other mirror indicators
- 3) Refer to [www.osram.com/am-guarantee](http://www.osram.com/am-guarantee) for precise conditions
- 4) Suitable for VW Golf VII (2012-2016), VW Golf 7.5 (2016->), VW Touran (2015->), VW Lamando (2014->)
- 5) Suitable for VW Passat B8 (2015->), VW CC (2017->), VW Arteon (2017->)
- 6) Suitable for BMW 1 series (2011->), BMW 2 series (2014->), BMW 3 series (2011-2019), BMW 4 series (2013->), BMW X1 (2009-2015)



ECE  
compliant

# OSRAM LEDriving<sup>®</sup> driving lights

## Light for dedicated application options

OSRAM's LED driving lights offer the most sophisticated LED technology and electrical design on the market. Products are available in three categories (functional, multifunctional and slim) offering a variety of performances, shapes and beam patterns with various illumination profiles like spot and combo. Products are available for 12 and 24 voltage vehicles.

### Features<sup>1)</sup>

- Different high beam patterns (spot and combo) with various beam angles available
- Powerful far field illumination
- Extremely high optic efficiency, homogeneous light distribution and reduced glaring
- Premium OSRAM quality
- Robust and compact design with long lifetime of up to 5,000 h thanks to integrated driver and thermal management system

### Benefits<sup>1)</sup>

- Improved illumination thanks to high brightness
- Better visibility due to daylight effect for increased road safety
- Lighting up the intended illumination area
- 5-year guarantee<sup>2)</sup>
- Extremely robust polycarbonate lens to endure heavy duty application, multiple voltage protection

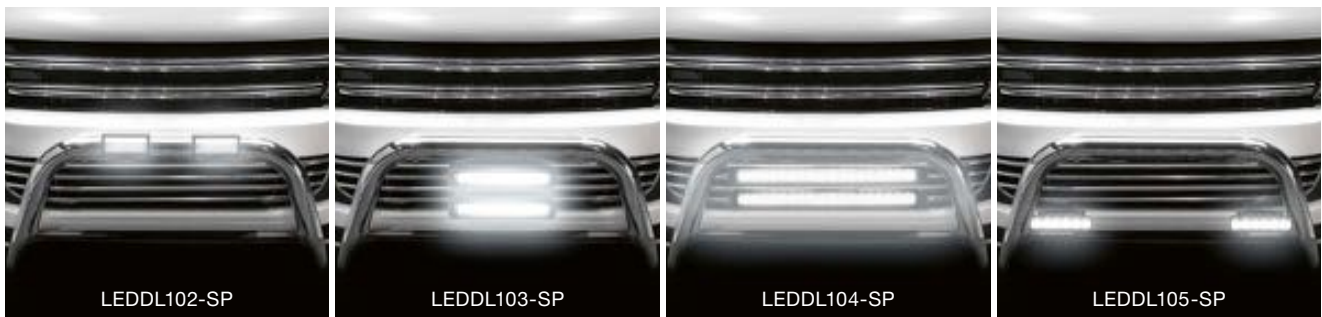

1) Driving lights must be installed in pairs for 12/24 V-vehicles | 2) Refer to [www.osram.com/am-guarantee](http://www.osram.com/am-guarantee) for precise conditions



**Multifunction series product range – OSRAM LED driving lights**



LEDriving® LIGHTBAR MX140-SP  
(LEDDL102-SP)

Product Reference	Product Number	V	W	K	l [mm]	w [mm]	h [mm]			No.
LEDDL102-SP <sup>1)</sup>	4052899 <b>595293</b>	12/24	30/2	6000	140	69,2	67	1	8	8 <sup>P.135</sup>

**Functional series product range – OSRAM LED driving lights**



LEDriving® LIGHTBAR FX250-SP  
(LEDDL103-SP)



LEDriving® LIGHTBAR FX250-CB  
(LEDDL103-CB)



LEDriving® LIGHTBAR FX500-SP  
(LEDDL104-SP)



LEDriving® LIGHTBAR FX500-CB SM  
(LEDDL104-CB SM)

Product Reference	Product Number	V	W	K	l [mm]	w [mm]	h [mm]			No.
LEDDL103-SP <sup>1)</sup>	4052899 <b>595330</b>	12/24	35	6000	309	93,5	54	1	4	9 <sup>P.135</sup>
LEDDL103-CB <sup>1)</sup>	4052899 <b>595354</b>	12/24	35	6000	309	93,5	54	1	4	9 <sup>P.135</sup>
LEDDL104-SP <sup>1)</sup>	4052899 <b>595378</b>	12/24	36	6000	564	93,5	54	1	4	10 <sup>P.135</sup>
LEDDL104-CB <sup>1)</sup>	4052899 <b>595392</b>	12/24	68	6000	564	93,5	54	1	4	10 <sup>P.135</sup>
LEDDL104-CB SM <sup>3)</sup>	4052899 <b>614079</b>	12/24	68	6000	564	93,5	54	1	4	10 <sup>P.135</sup>

**Slim series product range – OSRAM LED driving lights**



LEDriving® LIGHTBAR SX180-SP  
(LEDDL105-SP)



LEDriving® LIGHTBAR SX300-SP  
(LEDDL106-SP)



LEDriving® LIGHTBAR SX500-SP  
(LEDDL107-SP)

Product Reference	Product Number	V	W	K	l [mm]	w [mm]	h [mm]			No.
LEDDL105-SP <sup>1)</sup>	4052899 <b>595415</b>	12/24	14	6000	182	63,5	50	1	8	11 <sup>P.135</sup>
LEDDL106-SP <sup>1)</sup>	4052899 <b>595439</b>	12/24	29	6000	350	63,5	50	1	4	12 <sup>P.135</sup>
LEDDL107-SP <sup>1)</sup>	4052899 <b>595453</b>	12/24	46	6000	556	63,5	50	1	4	13 <sup>P.135</sup>

3) Single Mount (SM), does not need to be installed in pairs for 12/24 V-vehicles



# OSRAM LEDriving<sup>®</sup> working lights

## Light for professional application options

OSRAM's LED working lights offer the most sophisticated LED technology and electrical design on the market. The products offer a variety of performances, shapes and beam patterns with various illumination profiles like spot and wide. Products are available for 12 and 24 voltage vehicles.

### Features

- Different high beam patterns (spot and wide) with various beam angles available
- Powerful illumination of the workplace
- Extremely high optic efficiency, homogeneous lightdistribution and reduced glaring
- Premium OSRAM quality
- Robust and compact design with long lifetime of up to 5,000 h thanks to integrated driver and thermal management system

### Benefits

- Improved illumination thanks to high brightness
- Better visibility due to daylight effect for increased-workplace safety
- Lighting up the intended illumination area
- 5-year guarantee<sup>1)</sup>
- Extremely robust polycarbonate lens to endure heavy duty application, multiple voltage protection



1) Refer to [www.osram.com/am-guarantee](http://www.osram.com/am-guarantee) for precise conditions



**Multifunctional series product range – OSRAM LED working lights**



LEDriving® CUBE  
MX85-SP  
(LEDDL101-SP)

LEDriving® CUBE  
MX85-WD  
(LEDDL101-WD)

LEDriving® LIGHTBAR  
MX140-WD  
(LEDDL102-WD)

Product Reference	Product Number	V	W	K	l [mm]	w [mm]	h [mm]			No.
LEDDL101-SP	4052899 <b>595255</b>	12	22/2	6000	85	57	121,5	1	8	7 <sup>P.135</sup>
LEDDL101-WD	4052899 <b>595279</b>	12	22/2	6000	85	57	121,5	1	8	7 <sup>P.135</sup>
LEDDL102-WD	4052899 <b>595316</b>	12/24	30/2	6000	140	69,2	67	1	8	8 <sup>P.135</sup>



# OSRAM LEDriving<sup>®</sup> daytime running lights

## Stylish highlights for state-of-the-art headlights

Innovative, easy-to-install lightguide and pixel solution with high-quality LED technology for low energy consumption and long lifetime: LEDriving<sup>®</sup> daytime running lights are the right choice for drivers who want to increase visibility during the day and with an eye for design.

### Features of LG (LEDDRL102)

- Lightguide technology for homogeneous light distribution
- LED daytime running light including position light
- Color temperatures of up to 6,000 K
- Premium OSRAM quality
- OEM technology with long lifetime of up to 5,000 h and low energy consumption

### Benefits of LG (LEDDRL102)

- Pixel-free brilliance and dynamic curves
- Dimmable light functions
- Perfect color match for existing HID and LED systems with cool white and stylish LED light
- 5-year guarantee<sup>1)</sup>
- Simple installation and compatible with start-stop system and hybrid vehicles

### Features of PX-5 (LEDDRL301 CL15)

- Faceted optic and dotted pixel technology
- LED daytime running light (ECE certified)
- Color temperatures of up to 5,200 K
- Premium OSRAM quality
- Long lifetime of up to 5,000 h with low energy consumption



### Benefits of PX-5 (LEDDRL301 CL15)

- Dynamic appearance of the daytime running lights
- Legal LED upgrade by improving both visibility and style
- Perfect color match for existing HID and LED systems with cool white and stylish LED light
- 3-year guarantee<sup>1)</sup>
- Simple installation

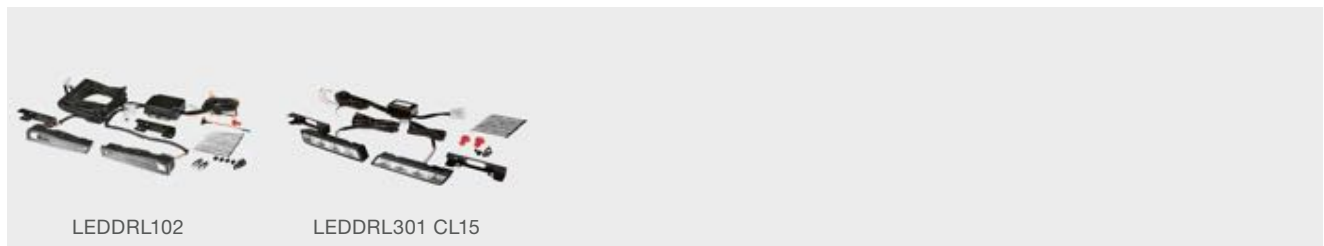

**OSRAM LEDDriving® daytime running light product range**



Product Reference	Product Number	V	W	K	$\frac{l}{[mm]}$ <sup>3)</sup>	$\frac{w}{[mm]}$ <sup>3)</sup>	$\frac{h}{[mm]}$ <sup>3)</sup>			 No.
LEDDRL102 <sup>2)</sup>	4052899 <b>200494</b>	12	15	6000	167	42	32	1	4	14 <sup>P.135</sup>
LEDDRL301 CL15 <sup>2)</sup>	4052899 <b>170766</b>	12	13.5	5200	160	30	23	1	5	15 <sup>P.135</sup>

1) Refer to [www.osram.com/am-guarantee](http://www.osram.com/am-guarantee) for precise conditions

2) Compatible with start-stop-system and hybrid vehicles

3) Product measurements



# OSRAM LEDriving<sup>®</sup> fog lights

## Better sight, better looks

LEDriving<sup>®</sup> fog lights offer brilliant LED options for tuning and technology fans. Improving both visibility and style, they perfectly complement one's headlights. Additional mounting brackets to install LEDriving<sup>®</sup> fog lights to different car models are available.

### Features of FOG<sup>1)</sup> (LEDFOG102)

- Faceted with Lightguide technology
- LED fog light with daytime running light functionality
- Color temperatures of up to 6,000 K
- Premium OSRAM quality
- OEM technology with long lifetime of up to 5,000 h

### Benefits of FOG<sup>1)</sup> (LEDFOG102)

- For homogeneous light distribution, suitable for 12 V and 24 V onboard power supply systems
- Simple installation with automatic operation thanks to intelligent control
- Perfect color match for existing HID and LED systems with cool white and stylish LED light
- 5-year guarantee<sup>2)</sup>
- Lens resistant to gravel impact according to ASTM D256 and ISO 179

### Features of MOUNTING BRACKET

- Brackets for installation of LED fog lights
- Fits most car models with 90-mm fog lights
- Available for: Toyota, Volkswagen, Nissan and Infiniti car models
- OSRAM quality

### Benefits of MOUNTING BRACKET

- Facilitating the installation of the OSRAM LED fog lights
- Simple installation, no further modifications required
- Adjustable for light cut-off
- 2-year guarantee<sup>2)</sup>



**Check the compability of your car!**  
 Vehicle Finder: [www.osram.com/fog-finder](http://www.osram.com/fog-finder)



**OSRAM LEDDriving® FOG product range**

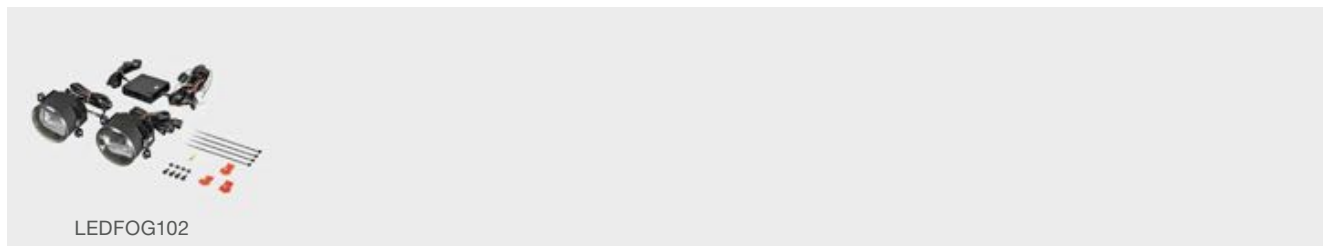

Product Reference	Product Number	V	W	K	$\frac{l}{(mm)}$ <sup>3)</sup>	$\frac{w}{(mm)}$ <sup>3)</sup>	$\frac{h}{(mm)}$ <sup>3)</sup>			
LEDFOG102	4052899 <b>211490</b>	12/24	16/24	6000	114	97.5	90	1	4	16 <sup>P.135</sup>

**OSRAM LEDDriving® MOUNTING BRACKET product range**



Product Reference	Product Number	V	W	K	$\frac{l}{(mm)}$ <sup>3)</sup>	$\frac{w}{(mm)}$ <sup>3)</sup>	$\frac{h}{(mm)}$ <sup>3)</sup>			
LEDFOG101-TY-M	4052899 <b>094550</b>	-	-	-	120	102	54	1	4	-
LEDFOG101-VW-M	4052899 <b>274495</b>	-	-	-	103	66.5	94	1	4	-
LEDFOG101-NIS-M	4052899 <b>274518</b>	-	-	-	137	95	33	1	4	-
LEDFOG101-INF-M	4052899 <b>301757</b>	-	-	-	114	97.5	90	1	4	-

1) LEDCBCTRL103 (P.32) avoids error messages on the board computer when using LED fog lights within 50 W applications  
 2) Refer to [www.osram.com/am-guarantee](http://www.osram.com/am-guarantee) for precise conditions | 3) Product measurements



#### Features of FOG PL<sup>1)</sup> (LEDFOG103)

- Color projection lense of LED fog light
- LED fog light with daytime running light (ECE certified) functionality
- Color temperatures of up to 6,000 K
- Premium OSRAM quality
- Long lifetime of up to 5,000 h

#### Features of F1<sup>1)</sup> (LEDFOG201)

- LED fog light (ECE certified)
- Color temperatures of up to 6,000 K
- Robust and stylish design
- Premium OSRAM quality
- OEM technology with long lifetime of up to 5,000 h

#### Features of MOUNTING BRACKET

- Brackets for installation of LED fog lights
- Fits most car models with 90-mm fog lights
- Available for: Toyota, Volkswagen and Nissan car models
- OSRAM quality

#### Benefits of FOG PL<sup>1)</sup> (LEDFOG103)

- Silver & blue color available for individual customization
- Legal LED upgrade by improving both visibility and style
- Perfect color match for existing HID and LED systems with cool white and stylish LED light
- 5-year guarantee<sup>2)</sup>
- More durability due to LED technology and simple installation thanks to built-in control box (mounting brackets available)

#### Benefits of F1<sup>1)</sup> (LEDFOG201)

- Legal LED upgrade by improving both visibility and style
- Perfect color match for existing HID and LED systems with cool white and stylish LED light
- Simple installation thanks to built-in control box (mounting brackets available)
- 3-year guarantee<sup>2)</sup>
- Lens resistant to gravel impact according to ASTM D256 and ISO 179

#### Benefits of MOUNTING BRACKET

- Facilitating the installation of the OSRAM LED fog lights
- Simple installation, no further modifications required
- Adjustable for light cut-off
- 2-year guarantee<sup>2)</sup>



**Check the compability of your car!**  
Vehicle Finder: [www.osram.com/fog-finder](http://www.osram.com/fog-finder)





**OSRAM LEDDriving® FOG PL and LEDDriving® F1 product range**



Product Reference	Product Number	V	W	K	$\overset{3)}{l}$ [mm]	$\overset{3)}{w}$ [mm]	$\overset{3)}{h}$ [mm]			No.
LEDFOG103-SR	4052899 <b>288898</b>	12	4/12	6000	114	95	90	1	4	17 <sup>P.135</sup>
LEDFOG103-BL	4052899 <b>288959</b>	12	4/12	6000	114	95	90	1	4	17 <sup>P.135</sup>
LEDFOG201	4052899 <b>197985</b>	12	8	6000	114	95.5	90	1	4	18 <sup>P.135</sup>

**OSRAM LEDDriving® MOUNTING BRACKET product range**



Product Reference	Product Number	V	W	K	$\overset{3)}{l}$ [mm]	$\overset{3)}{w}$ [mm]	$\overset{3)}{h}$ [mm]			No.
FOG103/201-TY-M	4052899 <b>223394</b>	-	-	-	120	96	77	1	4	-
FOG103/201-VW-M	4052899 <b>274457</b>	-	-	-	101	74	96	1	4	-
FOG103/201-NIS-M	4052899 <b>274471</b>	-	-	-	140	89	77	1	4	-

1) LEDCBCTRL103 (P.32) avoids error messages on the board computer when using LED fog lights within 50 W applications  
 2) Refer to [www.osram.com/am-guarantee](http://www.osram.com/am-guarantee) for precise conditions | 3) Product measurements



## LED STYLING LIGHTS

These automotive LED products allow anyone to create their own personal lighting ambience in a vehicle. Light is individually matched to personal preferences and purpose. Some products are controllable via remote or app for LED color changing options.



# OSRAM LEDambient® CONNECT

## Light is pulsating

The LEDambient® CONNECT family offers you to individualize your vehicle's look. Simple to install and run, these innovative LED products use Bluetooth® technology. Once paired to the free LEDambient® CONNECT app, you can synchronize your music with up to 10 LEDambient® CONNECT systems to pulse to the same beat.

### Features of PULSE CONNECT<sup>1)2)</sup>

- Bluetooth® enabled small disk with chrome finish that blends-in with your headlight assembly, making it barely visible
- App-controlled color mode
- Shines in various colors (RGB) and back onto reflector and pulses to the beat of your music
- OSRAM quality
- Connects directly to the battery or 12 V source

### Features of HYBRID CONNECT<sup>1)2)</sup>

- Bluetooth® enabled discreet system that adds color to your fog lights
- App-controlled color mode
- Shines in various colors (RGB) and pulses to the beat of music
- OSRAM quality
- High-performance halogen lamps with up to 4,200 K and 20% more brightness

### Features of TUNING LIGHTS CONNECT<sup>1)</sup>

- Bluetooth® enabled and app-controlled flexible self-adhesive LED strips
- App-controlled color mode
- Shines in various colors (RGB) and pulses to the beat of your music
- OSRAM quality
- Universal for use on any vehicle

### Benefits of PULSE CONNECT<sup>1)2)</sup>

- Eye-catching color upgrade for your headlights
- Dimmable via free OSRAM LEDambient® CONNECT app
- Easy to install, mounts to outer headlight assembly surface
- 2-year guarantee<sup>3)</sup>
- No switch required, can be installed in the car interior as well

### Benefits of HYBRID CONNECT<sup>1)2)</sup>

- Easy to install by replacing your existing fog lamps
- Dimmable via free OSRAM LEDambient® CONNECT app
- Fills your reflector with color through the lamps
- 2-year guarantee<sup>3)</sup>
- Available as HB3, HB4 and H10

### Benefits of TUNING LIGHTS CONNECT<sup>1)</sup>

- Extension kit available
- Dimmable via free OSRAM LEDambient® CONNECT app
- Providing RGB styling to the interior of the vehicle
- 2-year guarantee<sup>3)</sup>
- Easy to install with no soldering or use of screws



Download the app  
[www.osram.com/ledambient-app](http://www.osram.com/ledambient-app)



### OSRAM LEDambient® PULSE CONNECT product range

Product Reference	Product Number	V	COLOR			Light No.
LEDEXT101	4052899408104	12	Multicolor	1	2	19 <sup>P.135</sup>
LEDINT103	4052899408081	12	Multicolor	1	2	19 <sup>P.135</sup>

### OSRAM LEDambient® HYBRID CONNECT product range

Product Reference	Product Number	V	W			Light No.
LEDEXT102-03	4052899490581	12	60	P20d	1	20 <sup>P.135</sup>
LEDEXT102-04	4052899490604	12	51	P22d	1	21 <sup>P.135</sup>
LEDEXT102-10	4052899490628	12	42	PY20d	1	21 <sup>P.135</sup>

### OSRAM LEDambient® TUNING LIGHTS CONNECT

Product Reference	Product Number	V	COLOR	KIT		Light No.
LEDINT102	4052899451575	12	Multicolor	Base Kit	1	22 <sup>P.136</sup>
LEDINT104	4052899474529	12	Multicolor	Extension Kit	1	23 <sup>P.136</sup>

1) These products do not have ECE approval. This means they must not be used on public roads in any exterior application. Use on public roads leads to cancellation of operating license and loss of insurance coverage. Several countries do not allow sale and use of these products. Please contact your local distributor for information on the availability in your country.

2) Do not use while driving | 3) Refer to [www.osram.com/am-guarantee](http://www.osram.com/am-guarantee) for precise conditions

# OSRAM LEDambient®

## Stylish interior ambient lighting

The LEDambient® interior lights enable you to illuminate every single corner of your car. The high brightness of the products combined with the intense color temperatures puts your car into a new light. The LED strips are rapidly and easily mounted.



### Features of LEDambient® TUNING LIGHTS<sup>1)</sup>

- Flexible 16-color LED strips with adhesive backing
- Providing RGB styling to the interior of the vehicle
- 24-button wireless remote control
- OSRAM quality
- Adapter included for auto accessory plug-in

### Benefits of LEDambient® TUNING LIGHTS<sup>1)</sup>

- 4 flashing modes
- Dimmable
- Compact device for user-friendly operation
- 2-year guarantee<sup>2)</sup>
- Extension kit available



### Features of LEDambient® INTERIOR STRIP KIT<sup>1)</sup>

- High brightness thanks to 90 LEDs per 1.5 m strip
- White light with color temperature up to 4500 K
- Two flexible self-adhesive LED strips of 1.5 m
- OSRAM quality
- Two strips per packaging, individually shortenable after every 3rd LED

### Benefits of LEDambient® INTERIOR STRIP KIT<sup>1)</sup>

- Illuminate every corner of your car, commercial vehicle or caravan
- Interior lighting for the vehicle roof, loading area, trunk or other cabinet lighting application
- Easy to install with no soldering or use of screws
- 2-year guarantee<sup>2)</sup>
- Individual length adjustment for various application purposes



**OSRAM LEDambient® TUNING LIGHTS product range**



Product Reference	Product Number	V	COLOR	KIT			No.
LEDINT201	4052899933576	12	Multicolor	Base Kit	1	2	-
LEDINT201-SEC	4052899248809	12	Multicolor	Base Kit	1	2	-
LEDINT202 <sup>3)</sup>	4052899933590	12	Multicolor	Extension Kit	1	2	-

**OSRAM LEDambient® INTERIOR STRIP KIT product range**

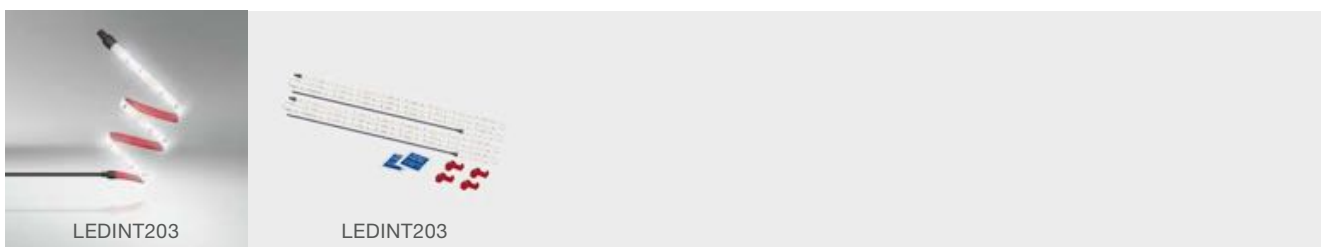

Product Reference	Product Number	V	COLOR	KIT			No.
LEDINT203	4052899516670	12	White color	-	1	2	24 <sup>P.136</sup>

1) These products do not have ECE approval. This means they must not be used on public roads in any exterior application. Use on public roads leads to cancellation of operating license and loss of insurance coverage. Several countries do not allow sale and use of these products. Please contact your local distributor for information on the availability in your country.  
 2) Refer to [www.osram.com/am-guarantee](http://www.osram.com/am-guarantee) for precise conditions | 3) Only works in combination with the base kit

# LED ACCESSORIES

LED inspection lights, reading lights for vehicle interior and safety lights are mobile helpers with strong lumen output. These highly practical, mobile, and energy-efficient light sources are based on LED technology, enhanced by handy, ergonomic – and even elegant – designs to improve the daily work and life.







# OSRAM LEDinspect® PRO

## Essential to your garage

A full line of premium inspection lights, specially-developed for the complex maintenance and repairs you tackle every day, reinvents light, turning it into a functional tool for your garage. LEDinspect® PRO enhances visibility with advanced LEDs that deliver exceptional luminosity. Each unique light design reflects an understanding of professional applications and supplies light precisely where you need it. Many lights include features, such as magnets, clips, hooks, torches, and extensions to direct light and give you hands-free options.



### Features of

#### SLIMLINE 500 (LEDIL108)

- Luminance: 500 lm and 250 lm (2 lighting settings)
- Battery status display
- Magnetic with protection class: IP42, IK07
- Premium OSRAM quality with slim premium design (aluminium)
- Long lifetime thanks to powerful long-lasting LEDs

### Benefits of

#### SLIMLINE 500 (LEDIL108)

- Excellent illumination for all types of professional inspection and maintenance
- Rechargeable 3.6 V 2,600 mAh Li-ion battery, charge via USB port & DC/AC (with charging cable)
- Flexible mounting possibilities as well as very dirt-resistant
- 3-year guarantee<sup>1)</sup>
- More durability due to LED technology for a very long service life



### Features of

#### POCKET 280 (LEDIL107)

- Luminance: 280 lm (high), 70 lm (low)
- Battery status display
- Magnetic with hook and protection class: IP20
- Premium OSRAM quality with compact and premium design (aluminium)
- Long lifetime thanks to powerful long-lasting LEDs

### Benefits of

#### POCKET 280 (LEDIL107)

- Excellent illumination for all types of professional inspection and maintenance
- Rechargeable 3.7 V 2,000 mAh Li-Polymer battery, charge via USB port & DC/AC (with charging cable)
- Flexible mounting possibilities as well as very dirt-resistant
- 3-year guarantee<sup>1)</sup>
- More durability due to LED technology for a very long service life



**Features of  
PENLIGHT 150 UV-A (LEDIL106)**

- Luminance: 150 lm (high), UV light (low)
- Battery status display
- Magnetic with clip and protection class: IP20
- Premium OSRAM quality with compact design (aluminium)
- Long lifetime thanks to powerful long-lasting LEDs

**Benefits of  
PENLIGHT 150 UV-A (LEDIL106)**

- Excellent illumination by identifying leaks in the air condition thanks to integrated UV light
- Rechargeable 800 mAh Li-Polymer battery, charge via USB port & DC/AC (with charging cable)
- Flexible mounting possibilities as well as very dirt-resistant
- 3-year guarantee<sup>1)</sup>
- More durability due to LED technology for a very long service life



**Features of  
PENLIGHT 150 (LEDIL105)**

- Luminance: 150 lm (high), 35 lm (low)
- Battery status display
- Magnetic with clip and protection class: IP20
- Premium OSRAM quality with compact design (aluminium)
- Long lifetime thanks to powerful long-lasting LEDs

**Benefits of  
PENLIGHT 150 (LEDIL105)**

- Excellent illumination for all types of professional inspection and maintenance
- Rechargeable 800 mAh Li-Polymer battery, charge via USB port & DC/AC (with charging cable)
- Flexible mounting possibilities as well as very dirt-resistant
- 3-year guarantee<sup>1)</sup>
- More durability due to LED technology for a very long service life

1) Refer to [www.osram.com/am-guarantee](http://www.osram.com/am-guarantee) for precise conditions



#### Features of

##### **BONNET 1400 (LEDIL104)**

- Luminance: 1400 lm
- Operable via 5 m cable and adjustable telescopic mounting bracket
- Protection class: IP65, IK06
- Premium OSRAM quality with ultra-slim design
- Long lifetime thanks to powerful long-lasting LEDs

#### Benefits of

##### **BONNET 1400 (LEDIL104)**

- Excellent illumination for all types of professional inspection and maintenance
- Flexible working for mounting under the hood of the vehicle or with integrated hook
- Easy-to-grip and dirt-resistant surface
- 3-year guarantee<sup>1)</sup>
- More durability due to LED technology for a very long service life



#### Features of

##### **SLIMLINE 280 (LEDIL103)**

- Luminance: 280 lm (high), 70 lm (low)
- Battery status display
- Protection class: IP42 / IK06
- Premium OSRAM quality with slim design
- Long lifetime thanks to powerful long-lasting LEDs



#### Benefits of

##### **SLIMLINE 280 (LEDIL103)**

- Excellent illumination for all types of professional inspection and maintenance
- Rechargeable 2,000 mAhLi-ion battery, charge via USB port & DC/AC (with charging cable)
- Easy-to-grip and dirt-resistant surface
- 3-year guarantee<sup>1)</sup>
- More durability due to LED technology for a very long service life



**OSRAM LEDinspect® PRO product range**

Product Reference	Product Number	V	W	Im	lx	K	$\frac{l}{[mm]}$ <sup>3)</sup>	$\frac{w}{[mm]}$ <sup>3)</sup>	$\frac{h}{[mm]}$ <sup>3)</sup>			 No.
LEDIL108	4052899559349	3.6	6	500/250	900/450 <sup>2)</sup>	6000	346	44	24	1	4	30 <sup>P.136</sup>
LEDIL107	4052899963863	3.7	1	280/70	480/500 <sup>2)</sup>	6000	133	64	17	1	4	29 <sup>P.136</sup>
LEDIL106	4052899963849	3.7	0.5	150/UVA	300 <sup>2)</sup>	6000	177	23	14	1	4	28 <sup>P.136</sup>
LEDIL105	4052899963825	3.7	0.5	150/35	300/100 <sup>2)</sup>	6000	177	23	14	1	4	27 <sup>P.136</sup>
LEDIL104	4052899970632	220	13-15	1.400	900 <sup>2)</sup>	6000	1104	50	50	1	4	26 <sup>P.136</sup>
LEDIL103	4052899327351	3.4	3.5	280	500 <sup>2)</sup>	6000	285	37	26	1	4	25 <sup>P.136</sup>

1) Refer to [www.osram.com/am-guarantee](http://www.osram.com/am-guarantee) for precise conditions  
 2) Up to  
 3) Product measurements



# OSRAM LEDinspect®

## Essential to your DIY toolbox

LEDinspect® simplifies DIY projects – specially-developed for maintaining and repairing vehicles, transforms light from an afterthought into a functional tool. The design of each lamp takes into account how the light is used and includes different extra features, such as magnets, clips, hooks, and rotatable heads, all housed in perfectly-sized packages and various light settings to ease work.



### Features of

#### HEADLAMP 300 (LEDIL209)

- Luminance: 300 lm (100%), 60 lm (20%)
- Protection class: IP64, IK07
- Works with three AA batteries (included)
- Headlamp with 75% angle adjustment
- Increased lifetime thanks to long-lasting LEDs

### Benefits of

#### HEADLAMP 300 (LEDIL209)

- Multifunctional headlamp with zooming effect, flashing option and red warning light for higher visibility on the back
- Easy-to-grip and dirt-resistant surface
- Immediate usage after purchase for hand-free working thanks to head fixing (size adjustable)
- 2-year guarantee<sup>1)</sup>
- More durability due to LED technology for a long service life



### Features of

#### PROFESSIONAL 150 (LEDIL207)

- Luminance: 150 lm (high), 70 lm (low)
- Magnetic with clip, rotatable hook and protection class: IP44, IK06
- Rechargeable 3.7 V 2,000mAh Li-ion battery
- OSRAM quality in handy and compact design with multifunctional features
- Increased lifetime thanks to long-lasting LEDs

### Benefits of

#### PROFESSIONAL 150 (LEDIL207)

- Ideal illumination for all types of inspection and maintenance
- Flexible mounting possibilities as well as dirt-resistant
- Easy charge via USB port & DC/AC (with charging cable)
- 2-year guarantee<sup>1)</sup>
- More durability due to LED technology for a long service life



**Features of**

**SLIMLINE 250 (LEDIL206)**

- Luminance: 250 lm (high), 30 lm (low)
- Magnetic with protection class: IP44, IP07
- Rechargeable 3.7 V 2,600mAh Li-ion battery
- OSRAM quality in light slim design
- Increased lifetime thanks to long-lasting LEDs

**Benefits of**

**SLIMLINE 250 (LEDIL206)**

- Ideal illumination for all types of inspection and maintenance
- Flexible mounting possibilities as well as dirt-resistant
- Easy charge via USB port & DC/AC (with charging cable)
- 2-year guarantee<sup>1)</sup>
- More durability due to LED technology for a long service life



**Features of**

**FLASHLIGHT 15 (LEDIL205)**

- Luminance: 15 lm
- Protection class: IK07
- Rechargeable 3.6 V 80 mAh Ni-Mh
- OSRAM quality in small and compact design (pink & black available)
- Increased lifetime thanks to long-lasting LEDs

**Benefits of**

**FLASHLIGHT 15 (LEDIL205)**

- Ideal illumination for all types of inspection and maintenance
- Easy-to-grip and dirt-resistant surface
- Easy charge via 12 V cigarette lighter
- 2-year guarantee<sup>1)</sup>
- More durability due to LED technology for a long service life



**Features of**

**POCKET 160 (LEDIL204)**

- Luminance: 160 lm (high), 75 lm (low)
- Magnetic with hook, clip and protection class: IP44, IK07
- Rechargeable 3.7 V 1,500 mAh Li-ion battery
- OSRAM quality in small and compact design with multifunctional features
- Increased lifetime thanks to long-lasting LEDs

**Benefits of**

**POCKET 160 (LEDIL204)**

- Ideal illumination for all types of inspection and maintenance
- Flexible mounting possibilities as well as dirt-resistant
- Easy charge via USB port & DC/AC (with charging cable)
- 2-year guarantee<sup>1)</sup>
- More durability due to LED technology for a long service life

1) Refer to [www.osram.com/am-guarantee](http://www.osram.com/am-guarantee) for precise conditions



**Features of**

**PENLIGHT 80 (LEDIL203)**

- Luminance: 80 lm (high)
- Magnetic with clip and protection class: IP20, IK06
- Works with three AAA batteries (included)
- OSRAM quality in small and compact design with multifunctional features
- Increased lifetime thanks to long-lasting LEDs

**Benefits of**

**PENLIGHT 80 (LEDIL203)**

- Ideal illumination for all types of inspection and maintenance
- Flexible mounting possibilities as well as dirt-resistant
- Immediate usage after purchase
- 2-year guarantee<sup>1)</sup>
- More durability due to LED technology for a long service life



**Features of**

**MINI 125 (LEDIL202)**

- Luminance: 125 lm (high), 90 lm (low)
- Magnetic with hook and protection class: IP44, IK07
- Works with three AAA batteries (included)
- OSRAM quality in small and compact design with multifunctional features
- Increased lifetime thanks to long-lasting LEDs

**Benefits of**

**MINI 125 (LEDIL202)**

- Ideal illumination for all types of inspection and maintenance
- Flexible mounting possibilities as well as dirt-resistant
- Immediate usage after purchase
- 2-year guarantee<sup>1)</sup>
- More durability due to LED technology for a long service life



**Features of**

**FOLDABLE 80 (LEDIL201)**

- Luminance: 80 lm (high), 25 lm (low)
- Magnetic with hook and protection class: IP44, IK07
- Battery status display
- OSRAM quality with compact and foldable design
- Increased lifetime thanks to long-lasting LEDs

**Benefits of**

**FOLDABLE 80 (LEDIL201)**

- Ideal illumination for all types of inspection and maintenance
- Flexible mounting possibilities as well as dirt-resistant
- Rechargeable Ni-Mh 3.6 V 1600 mAh battery (charging via 220 V adapter and 12 V cigarette lighter)
- 2-year guarantee<sup>1)</sup>
- More durability due to LED technology for a long service life





**OSRAM LEDinspect® product range**

Product Reference	Product Number	V	W	Im	lx	K	$\frac{l}{[mm]}$ <sup>4)</sup>	$\frac{w}{[mm]}$ <sup>4)</sup>	$\frac{h}{[mm]}$ <sup>4)</sup>				No.
LEDIL209	40528994 <b>25033</b>	4.5	3	300/60	272/43 <sup>2)</sup>	7000	90	89	68	1	4		38 <sup>P.136</sup>
LEDIL207	40528994 <b>25019</b>	3.7	3	150/70	58/217 <sup>2)</sup>	7000	210	52	40	1	4		37 <sup>P.136</sup>
LEDIL206	40528994 <b>24999</b>	3.7	3	250/30	96/20 <sup>2)</sup>	7000	320	39	25	1	4		36 <sup>P.136</sup>
LEDIL205-BKPK <sup>3)</sup>	40528995 <b>40477</b>	3.6	0.5	15	56 <sup>2)</sup>	7000	61	22.5	-	-	4		35 <sup>P.136</sup>
LEDIL205-PK	40528995 <b>39006</b>	3.6	0.5	15	56 <sup>2)</sup>	7000	61	22.5	-	1	10		35 <sup>P.136</sup>
LEDIL205	40528994 <b>24951</b>	3.6	0.5	15	56 <sup>2)</sup>	7000	61	22.5	-	1	10		35 <sup>P.136</sup>
LEDIL204	40528994 <b>24975</b>	3.7	0.5	160/75	70/30 <sup>2)</sup>	7000	127	63	34	1	4		34 <sup>P.136</sup>
LEDIL203	40528992 <b>75607</b>	4.5	1.5	80	250 <sup>2)</sup>	7000	160	16	32	1	12		33 <sup>P.136</sup>
LEDIL202	40528990 <b>09578</b>	4.5	1.6	125/90	1200 <sup>2)</sup>	6000	98	63	35	1	24		32 <sup>P.136</sup>
LEDIL201	40528990 <b>09592</b>	4.5	1.5	80/25	2000 <sup>2)</sup>	6000	220	46	51	1	10		31 <sup>P.136</sup>

1) Refer to [www.osram.com/am-guarantee](http://www.osram.com/am-guarantee) for precise conditions | 2) Up to | 3) Pink & black assortment | 4) Product measurements



# OSRAM LEDguardian® warning lights

## Prepared for serious situations

Two lights that should accompany every situation. ROAD FLARE is a powerful emergency flare, for signaling serious situations and improving visibility. SAVER LIGHT is a multifunctional torch that includes a seat-belt cutter, life hammer and flashing LED warning lights.



### Features of LEDguardian® ROAD FLARE<sup>1)</sup>

- Multifunctional LED warning light with rotating amber light (two modes flashing & continuous-on) and white torch light
- Magnetic with protection class: IP20
- Works with three AAA batteries (included)
- OSRAM quality
- Increased lifetime thanks to long-lasting LEDs

### Benefits of LEDguardian® ROAD FLARE<sup>1)</sup>

- See and be seen in emergency situations with up to 240 m distance
- Flexible mounting on various surfaces and crush-proof – doesn't break even when run over by a car<sup>3)</sup>
- Immediate usage after purchase
- 2-year guarantee<sup>2)</sup>
- More durability due to LED technology for a long service life



### Features of LEDguardian® SAVER LIGHT PLUS<sup>1)</sup>

- Multifunctional LED warning light with two light functions (amber flashing and white torch light)
- Emergency light with seat-belt cutter and emergency hammer
- Magnetic with holder and protection class: IP44, IK07
- OSRAM quality
- Increased lifetime thanks to long-lasting LEDs
- Works with two AA batteries (included)

### Benefits of LEDguardian® SAVER LIGHT PLUS<sup>1)</sup>

- Be prepared for serious situations, thanks to high quality, long lasting LEDs
- Getting out by smashing the window or cutting the seat-belt
- Flexible mounting possibilities as well as dirt-resistant
- 2-year guarantee<sup>2)</sup>
- More durability due to LED technology for a long service life



### OSRAM LEDguardian® ROAD FLARE

Product Reference	Product Number	V	W	COLOR	l [mm] <sup>4)</sup>	w [mm] <sup>4)</sup>	h [mm] <sup>4)</sup>			No.
LEDSL302	4052899184053	4.5	0.5	Amber/White	110	42	-	1	24	39 <sup>P.136</sup>

### OSRAM LEDguardian® SAVER LIGHT PLUS

Product Reference	Product Number	V	W	COLOR	l [mm] <sup>4)</sup>	w [mm] <sup>4)</sup>	h [mm] <sup>4)</sup>			No.
LEDSL101	4052899132344	3	1.7	Amber/White	180	63	53	1	6	40 <sup>P.136</sup>

1) Not approved as warning light according to German Road Traffic Licensing Regulations (StVZO). Not for sale in Germany.  
 2) Refer to [www.osram.com/am-guarantee](http://www.osram.com/am-guarantee) for precise conditions  
 3) Tested in a mid-range car at walking pace  
 4) Product measurements

# OSRAM ONYX COPILOT®

## Good light for a good ride

OSRAM ONYX COPILOT® is a flexible LED reading light that emits a pleasantly warm, glare-free light. With an appealing black design, the ONYX COPILOT® is available in three versions: ONYX-USB with USB plug in, ONYX M-7 is powered via cigarette lighter, ONYX L-7 comes with a plastic base for fixed connection.



### Features

- Bright LED reading light for vehicle interior, 12 V & 24 V compatible
- Individual adjustment thanks to bendable neck
- Different plug-in ports (cigarette lighter, USB port, fix mounting) available
- Service life (LED): up to 20,000 h
- High protection class

### Benefits

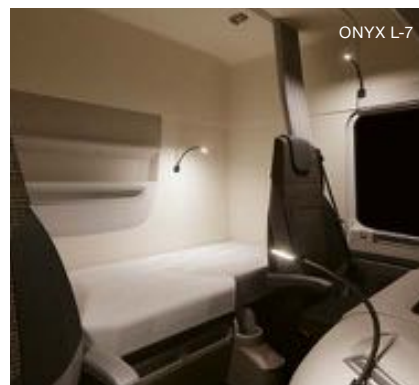

- Pleasant warm and glare-free LED light
- Light can be switched on/off and remain connected permanently
- Provides simple installation
- 2-year guarantee<sup>1)</sup>
- Pleasantly look and feel, easy to grip and dirt-resistant surface





**OSRAM LED ONYX COPILOT® product range**



Product Reference	Product Number	V	W	lx	K	$\frac{l}{[mm]}$ <sup>3)</sup>	$\frac{w}{[mm]}$ <sup>3)</sup>	$\frac{h}{[mm]}$ <sup>3)</sup>			 No.
ONYX-USB	4052899 <b>601000</b>	12/24	0.5	20	3000	370 <sup>2)</sup>	25	9	1	4	41 <sup>P.136</sup>
ONYX M-7	4052899 <b>07270</b>	12/24	0.5	20	3200	370 <sup>2)</sup>	25	9	1	4	42 <sup>P.136</sup>
ONYX L-7	4052899 <b>414938</b>	12/24	0.5	20	3200	370 <sup>2)</sup>	25	9	1	4	43 <sup>P.137</sup>

1) Refer to [www.osram.com/am-guarantee](http://www.osram.com/am-guarantee) for precise conditions

2) Not overall length of product

3) Product measurements



## Tools for all requirements – practical support in every- day life

As part of its holistic approach to products and marketing, OSRAM provides a large number of sets and tools to ensure the best possible support on the road and an attractive product presentation. Spare lamp kits make lamp replacement on the way possible. For retail outlets, filling stations and workshops practical lamp depots are available. High-quality displays and demonstration tools present and demonstrate products in a clear way, and with clear information. Your requirements are as unique as our OSRAM solutions.

# OSRAM workshop helpers

## Practical at work and for the POS

The easy-to-use Shelf Rack provides space for the most important passenger car or truck lamps from OSRAM. The robust assortment box allows quick, mobile access to the most frequently required MINIWATT® lamps for passenger cars. Last but not least, the Automotive Lamp Cabinet offers clear and easy access to the OSRAM 12 volt or 24 volt product range.



### Main benefits of Automotive Lamp Cabinet

- Clear lamp arrangement
- Slot system for easy removal
- Drawers for additional lamps
- Lamp tester optionally available
- Available with or without lock

### Main benefits of Shelf Rack

- Row of hooks for presenting blister packs, DUO BOXES, new products
- Ideal for workshops and filling stations, practical for everyday use
- High-quality material and eye-catching design, ideal OSRAM in-store placement

### Main benefits of MINIWATT® 12 V assortment box

- 18 different MINIWATT® 12 V lamps for passenger cars (total of 180 lamps), highlighted in color
- Equipment overview with the most important technical data directly in the box

1) We are happy to provide you with a proposal of stock. Please contact your local representative.



### OSRAM Automotive Lamp Cabinet

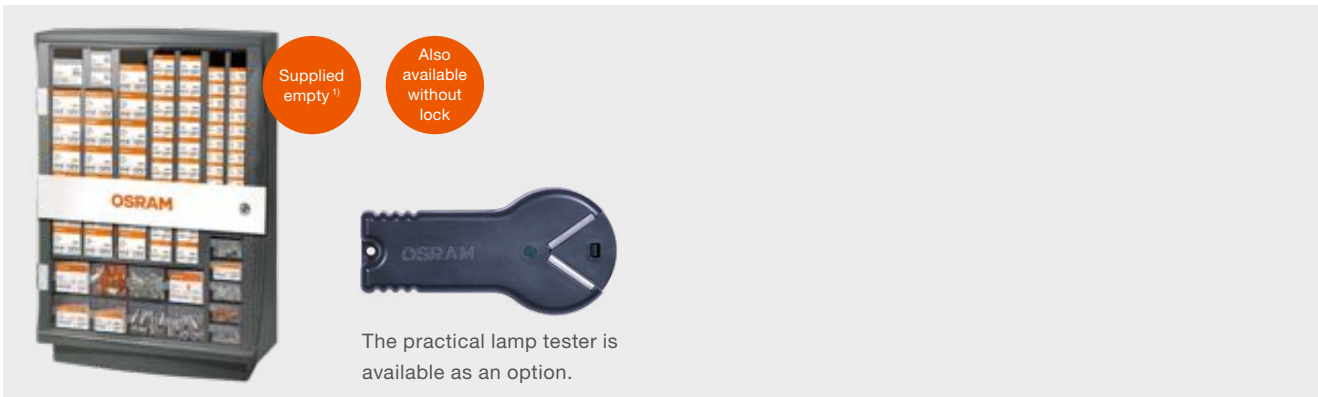

Product Reference	Product Number	Dimensions (W x H x D)
ALC without <sup>1)</sup>	4008321694355	405 x 572 x 190 mm
ALC with lock <sup>1)</sup>	4008321694362	405 x 572 x 190 mm
Lamp tester 50X1	4008321786951	-

### OSRAM Shelf Rack

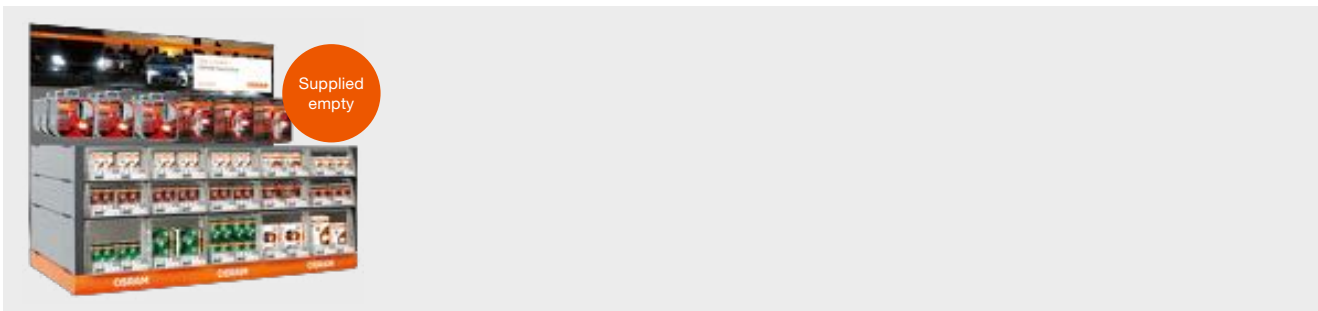

Product Reference	Product Number	Dimensions (W x H x D)
SHELF RACK	4008321211248	920 x 900 x 580 mm

### OSRAM MINIWATT® 12 V

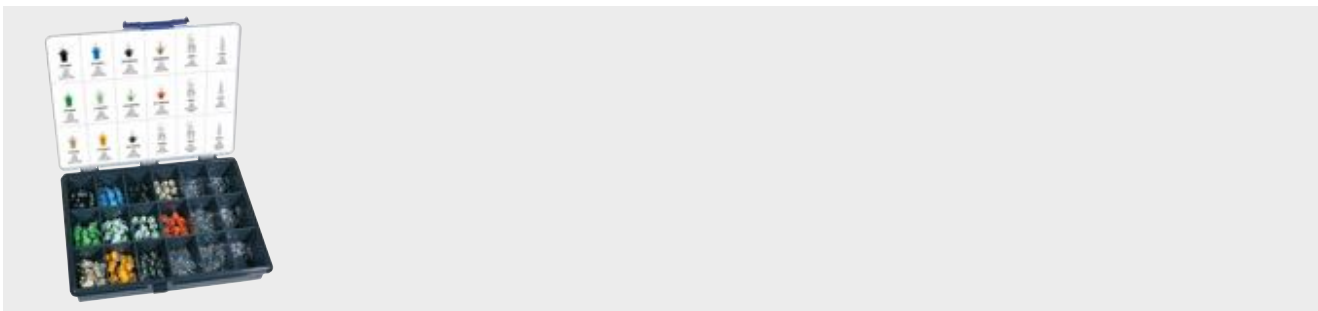

Product Reference	Product Number	Dimensions (W x H x D)	Contents	
509961	4008321082169	240 x 43 x 190 mm	180 lamps	3

# OSRAM Automotive demo tools

## Boost your customer's sales experience

Various types of OSRAM Automotive demo tools provide customers with opportunities to experience the wide range of product technologies at the point of sale. These tools not only portray all USPs but also allow your customer to test and compare different technologies, find the right product more easily and thus increase your sale.



### Main benefits of OSRAM demo tools

- Demonstrates multiple technologies
- Enables direct product comparison
- Test-me feature
- Real-life experience
- Easy to handle

## Demonstration tools

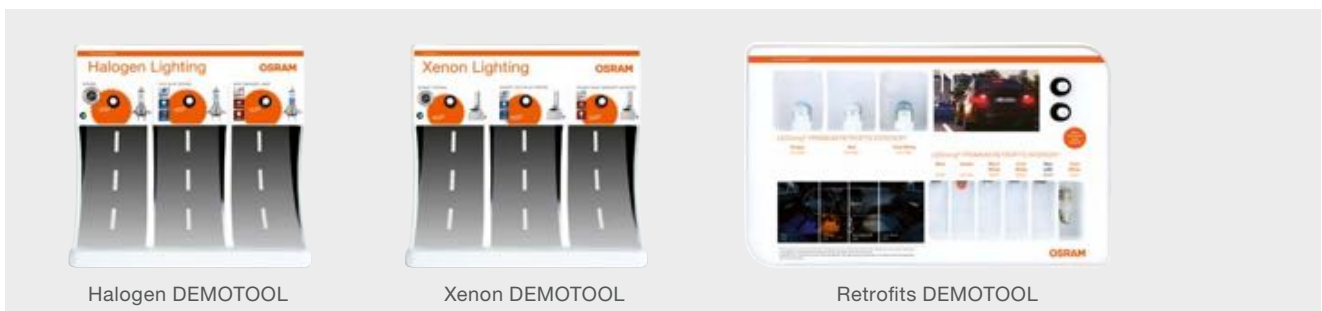

Product Reference	Product Number	Dimensions (W x H x D)
Halogen DEMOTOOL	4052899 <b>323070</b>	345 x 325 x 270 mm
Xenon DEMOTOOL	4052899 <b>323063</b>	345 x 325 x 270 mm
Retrofit DEMOTOOL	4052899 <b>579712</b>	365 x 225 x 75 mm

# OSRAM polePOStion® & displays

## Convincing product presentation

Attract customer attention with OSRAM's eye-catching instore solutions portfolio. From secondary placements up to a brand new shelf system, OSRAM's range of assortments stands out and shows all products at a glance. With the perfect tool for every type of merchandising solution you may need, OSRAM is your ideal partner.



### Main benefits of OSRAM Automotive polePOStion®

- Ideal and innovative construction mirroring the OSRAM portfolio segmentation
- Flexible, modern design for easy adaptation
- High-quality and extremely convenient presentation system
- Variable construction according to every store's requirements

### Main benefits of OSRAM displays

- Perfect product presentation
- Compact and eye-catching design
- High-quality and practical construction

### Automotive polePOsition® and Presentation Tools

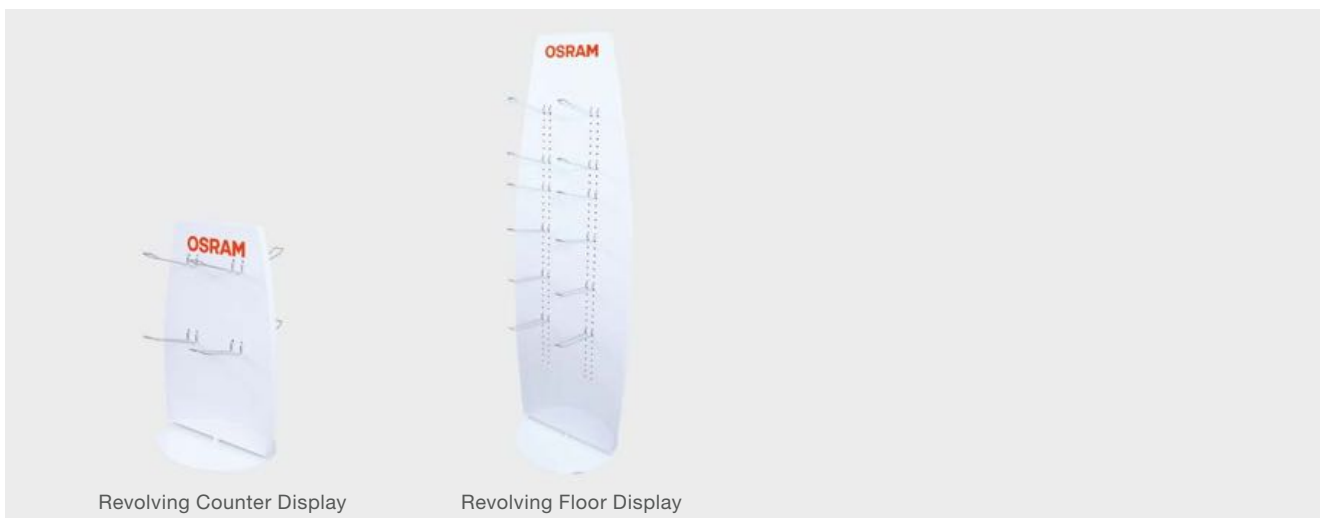

Product Reference	Product Number	Dimensions (W x H x D)	Content
Revolving Counter Display	4052899 <b>545663</b>	510 x 308 x 285 mm	-
Revolving Floor Display	4052899 <b>545717</b>	1540 x 455 x 385 mm	-



Please contact your responsible account manager if you are interested in our OSRAM Automotive polePOsition® and the new display designs. All order numbers of the individual elements can be found in the table above.

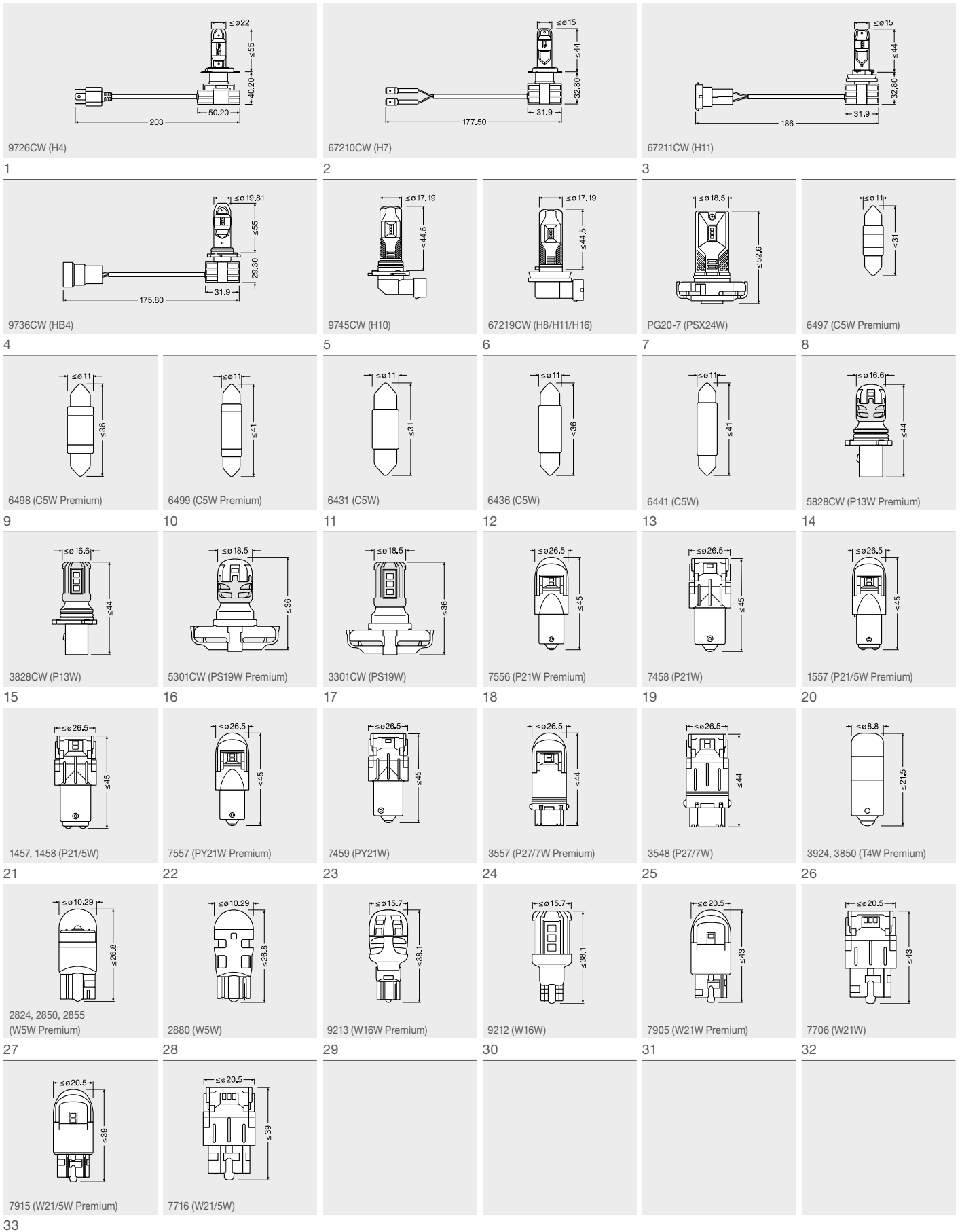

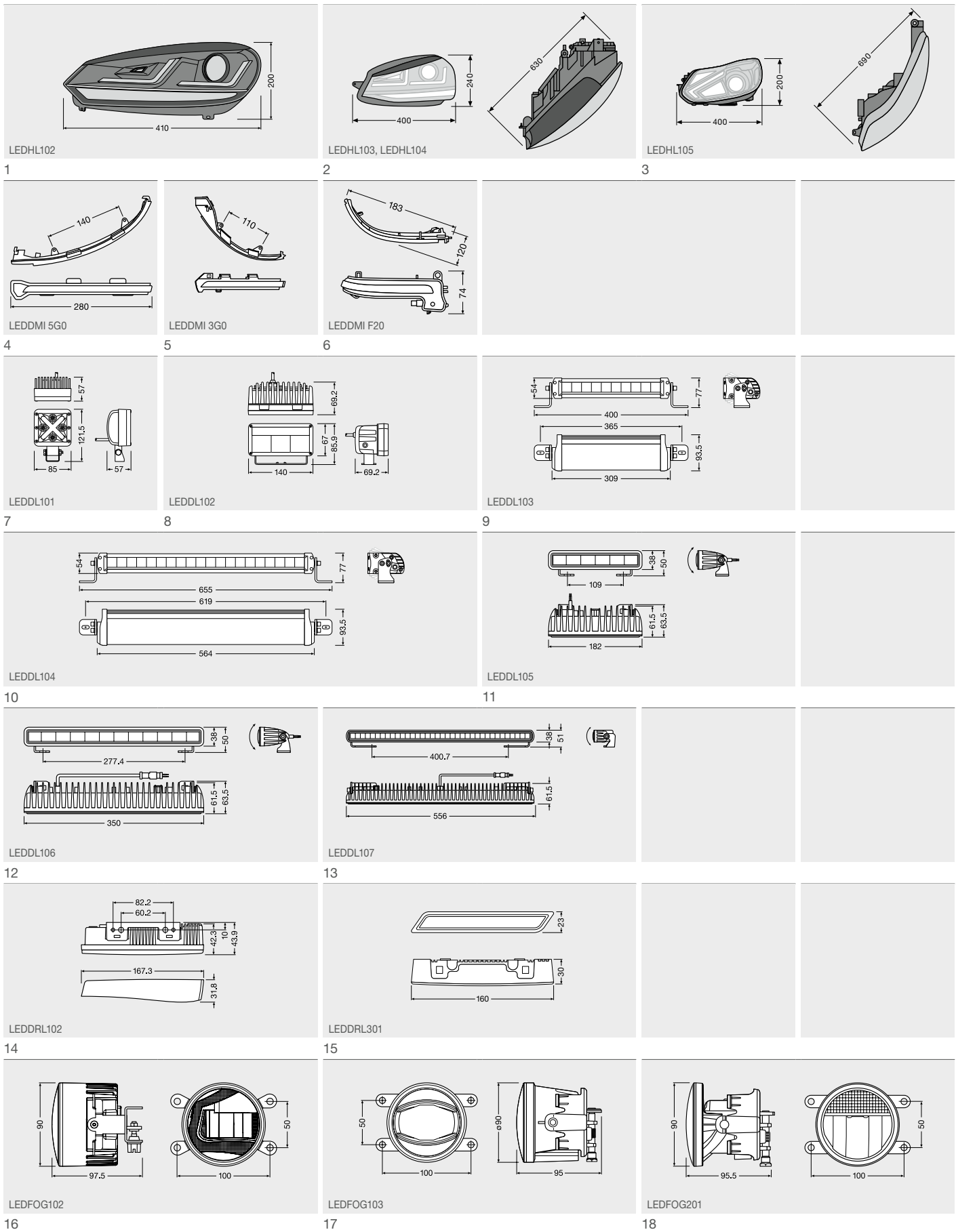

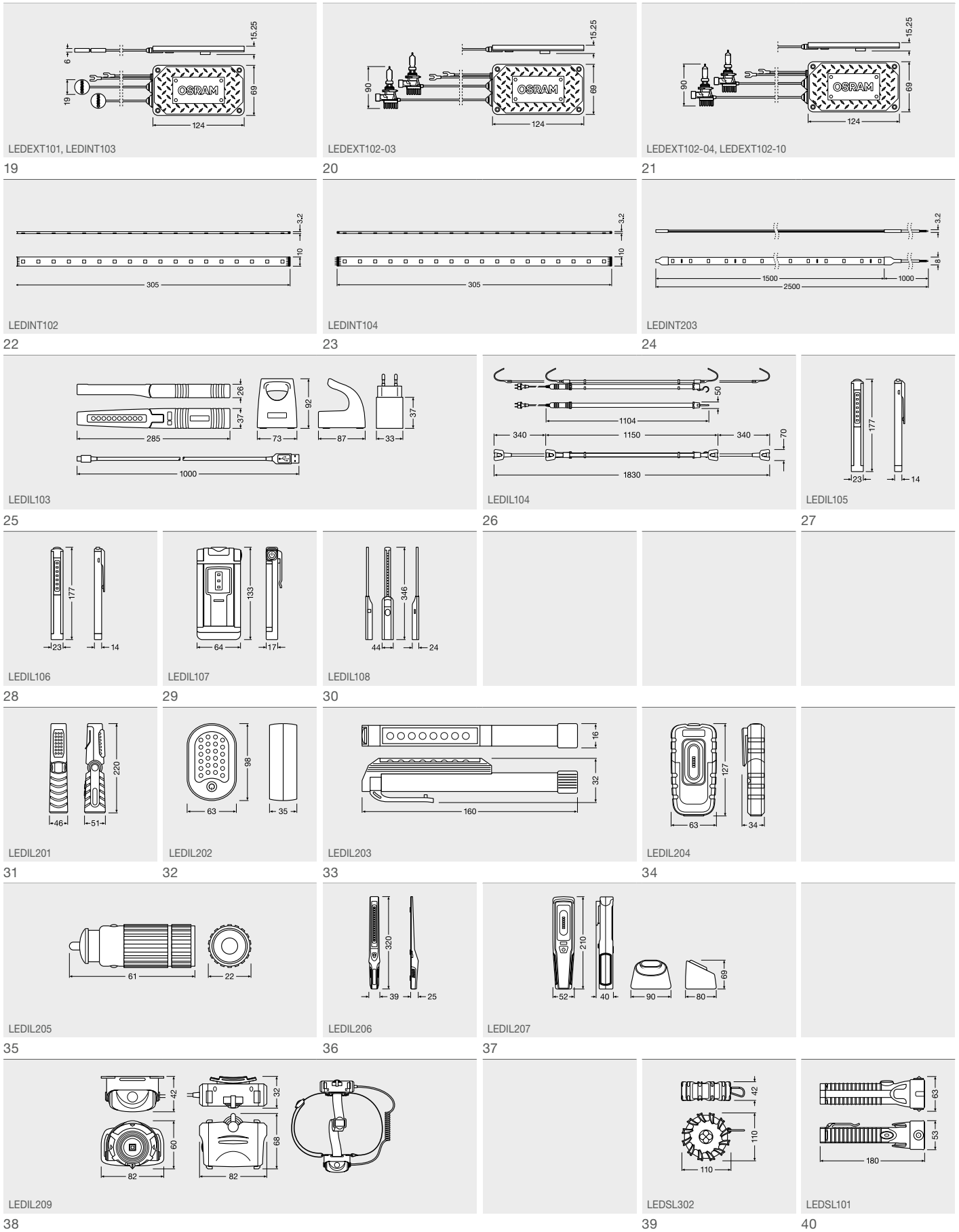



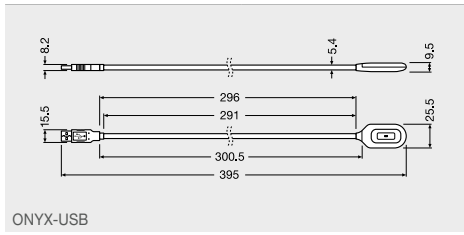

ONYX-USB

41

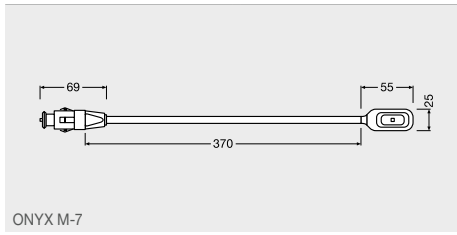

ONYX M-7

42

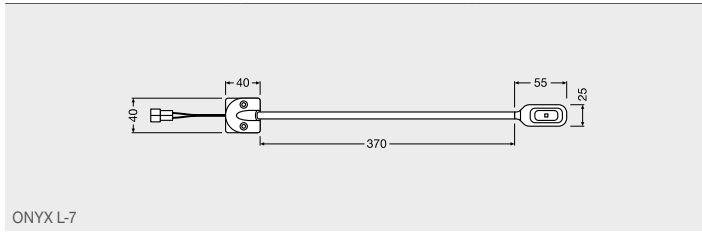



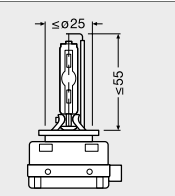
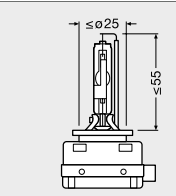
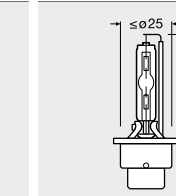
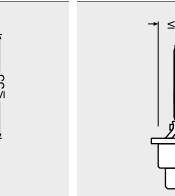
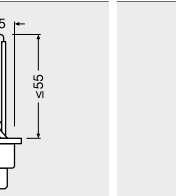
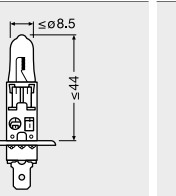
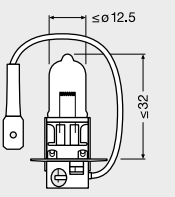
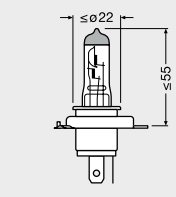
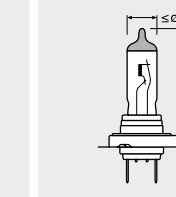
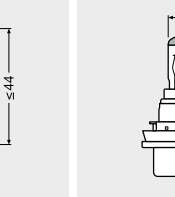
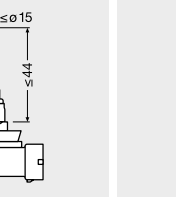
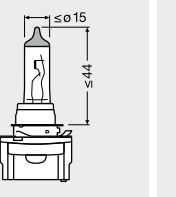
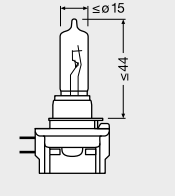
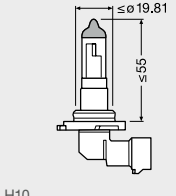
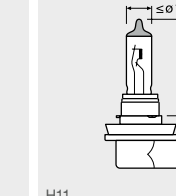
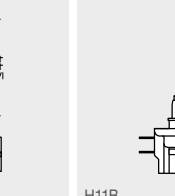
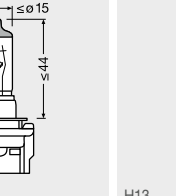
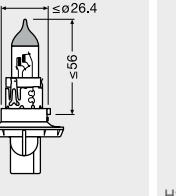
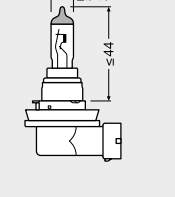
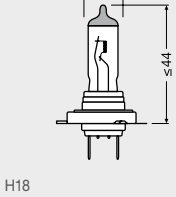
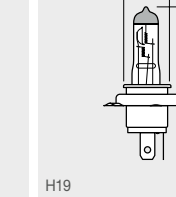
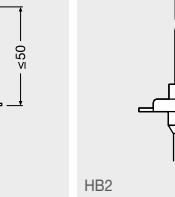
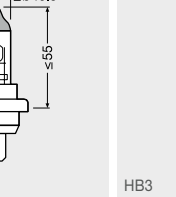
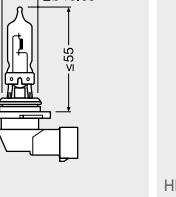
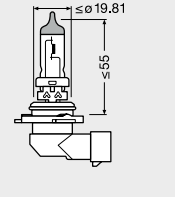
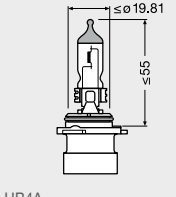
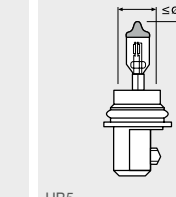
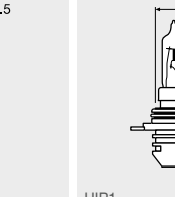
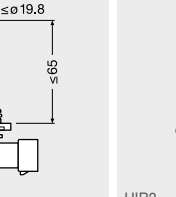
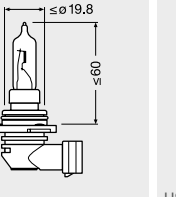
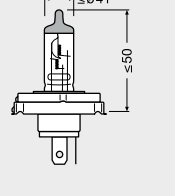
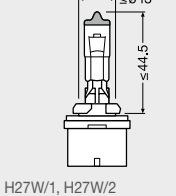
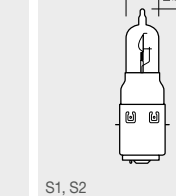
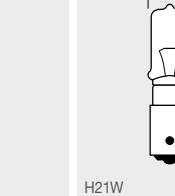
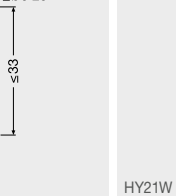
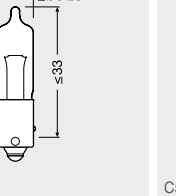
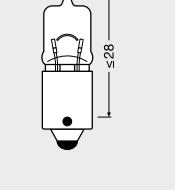
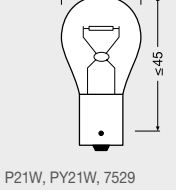
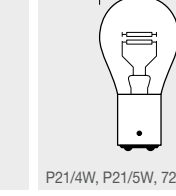
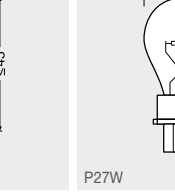
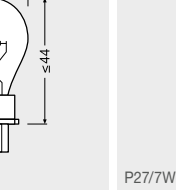
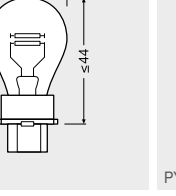

ONYX L-7

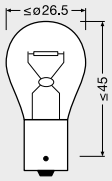
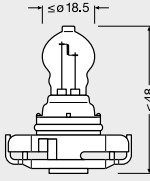
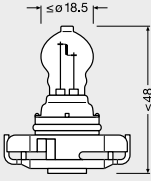
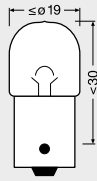
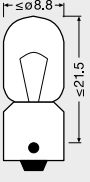
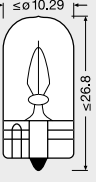
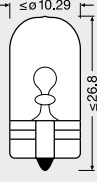
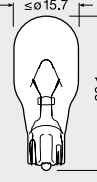
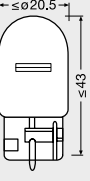
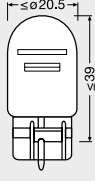
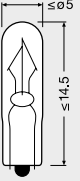
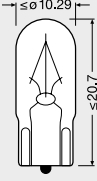
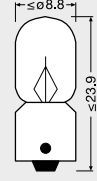
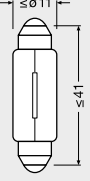
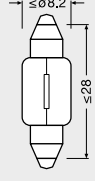
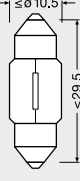
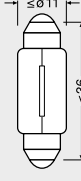
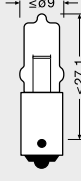
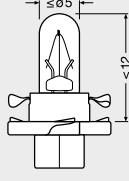
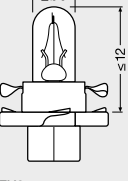
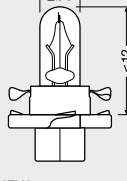
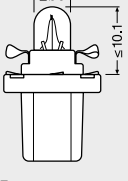
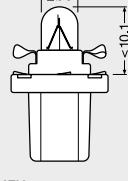
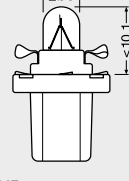
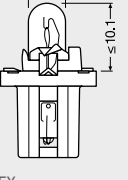
43

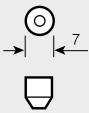
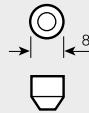
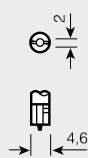

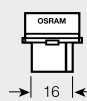
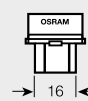
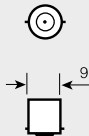
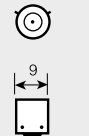
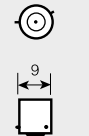
					
D1S, D3S	D1R, D3R, D8S	D2S, D4S	D2R, D4R	H1	H2
1	2	3	4	5	6
					
H3	H4	H7	H8	H8B	H9
7	8	9	10	11	12
					
H9B	H10	H11	H11B	H13	H15
13	14	15	16	17	18
					
H16	H18	H19	HB2	HB3	HB3A
19	20	21	22	23	24
					
HB4	HB4A	HB5	HIR1	HIR2	HS1
25	26	27	28	29	30
					
R2	H27W/1, H27W/2	S1, S2	H21W	HY21W	C5W
31	32	33	34	35	36
					
H6W	P21W, PY21W, 7529	P21/4W, P21/5W, 7240	P27W	P27/7W	PY27/7W
37	38	39	40	41	42

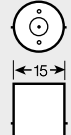
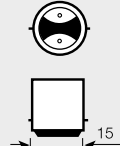
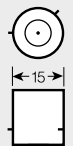
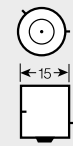
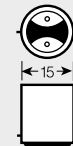
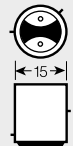
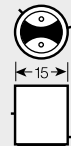
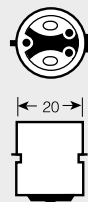
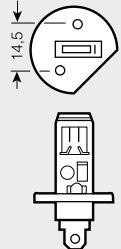
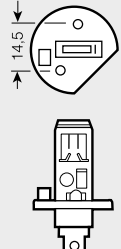
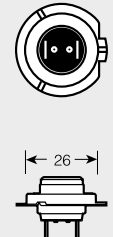
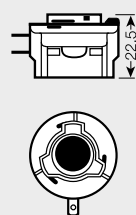
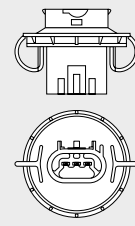
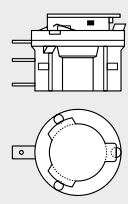
 PR21W	 PR21/5W	 PS19W	 PS24W	 PSX24W	 R5W, R10W, RY10W
43	44	45	46	47	48
 T4W, 3860	 W2.3W	 W3W, 2820	 W5W, WY5W, 2886X	 W16W	 WY16W
49	50	51	52	53	54
 W21W, WY21W	 W21/5W	 2341	 2721, 2722, 2741	 2840	 3796
55	56	57	58	59	60
 6411, 6413, 6421, 6424, 6429	 6428, 6430	 6438	 6461	 64111, 64113, 64115	 2351MFX6
61	62	63	64	65	66
 2352MFX6	 2452MFX6	 2473MFX6	 2721MF	 2721MFX	 2722MF
67	68	69	70	71	72
 2722MFX	 2741MF, 2741MFX				
73	74				

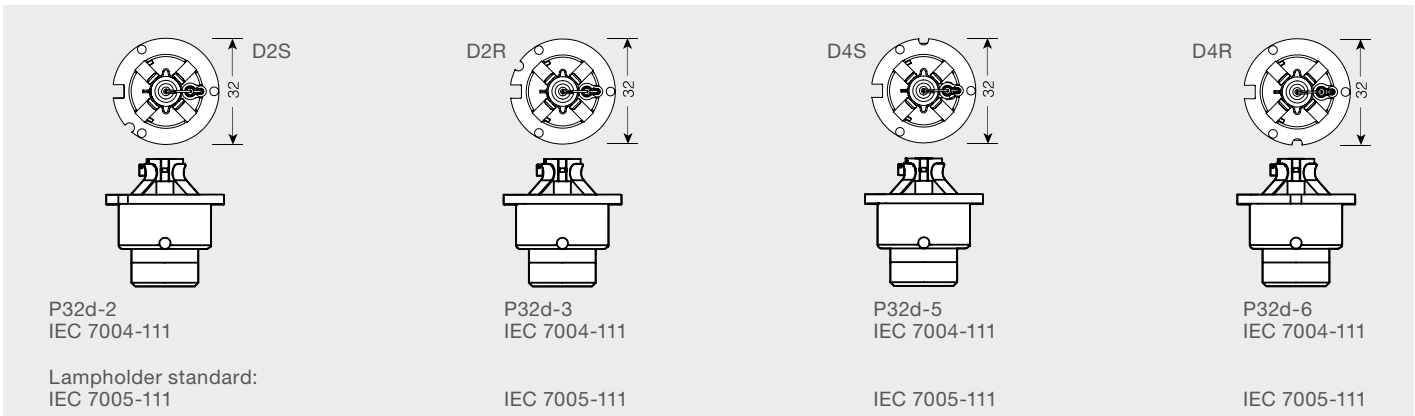
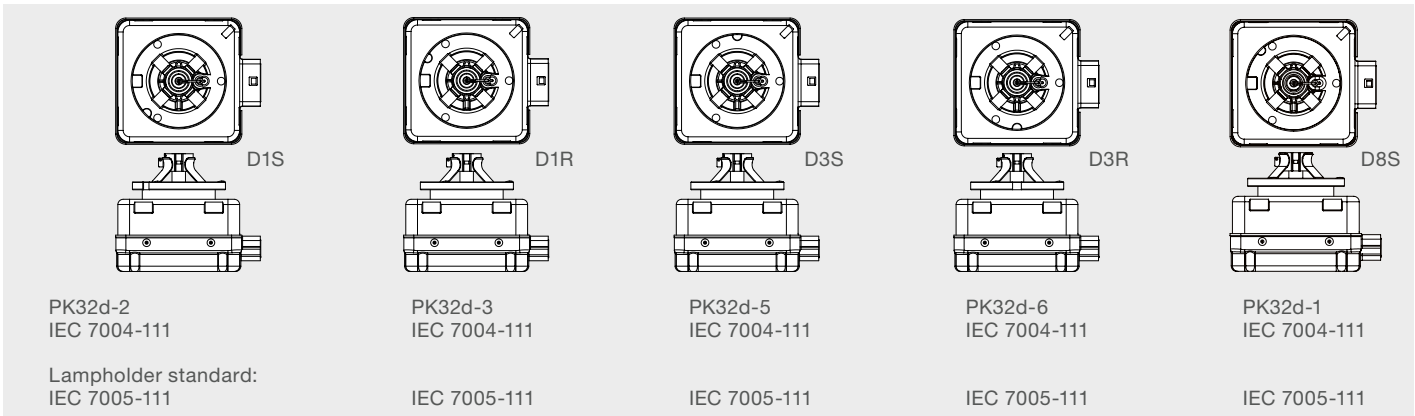
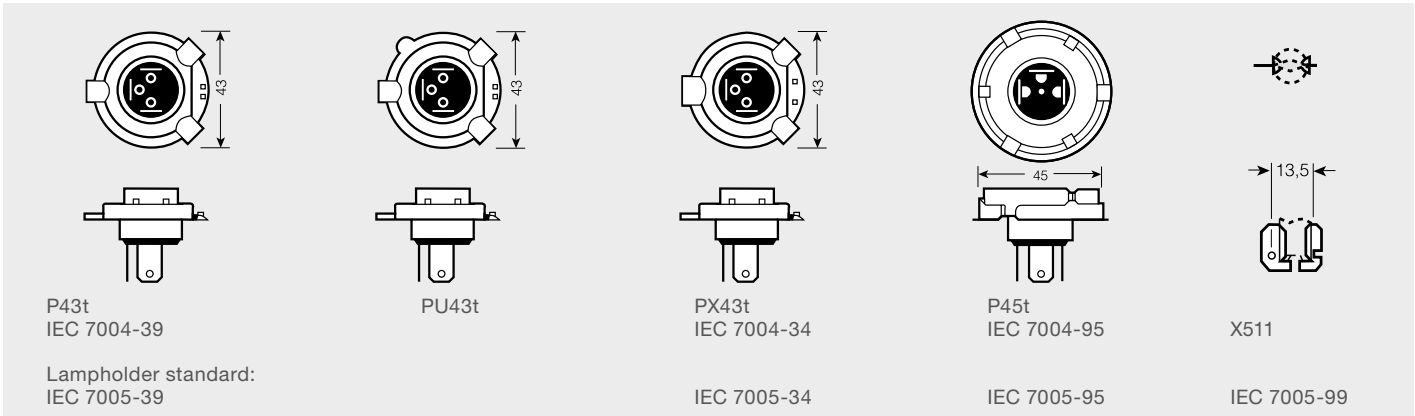
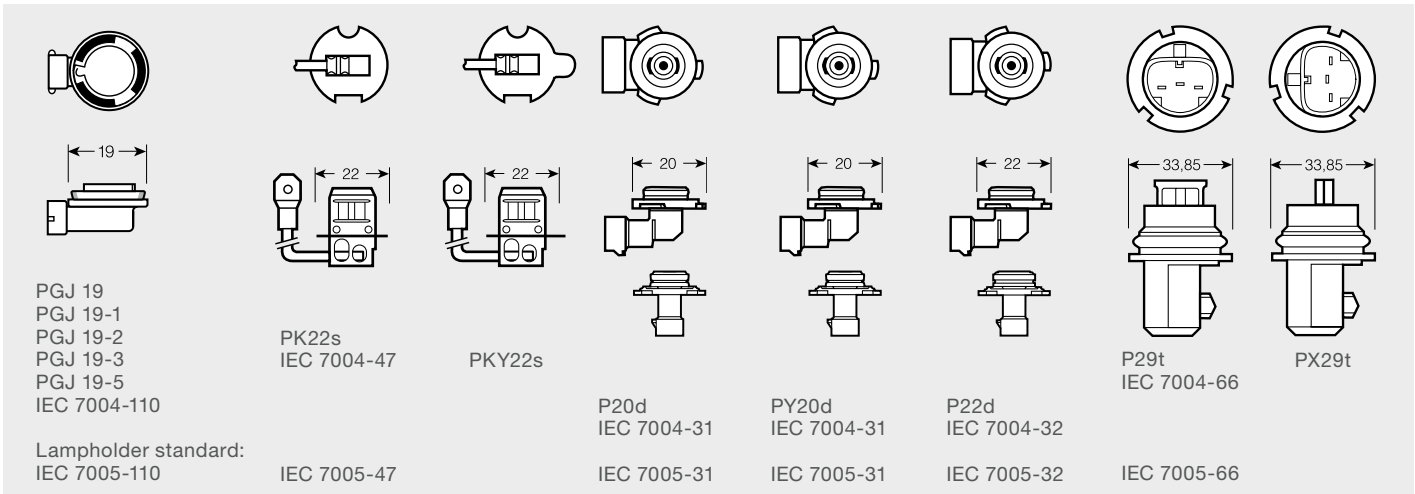
 <p>SV7-8 IEC 7004-80</p> <p>Lampholder standard: IEC 7005-80</p>	 <p>SV8.5-8 IEC 7004-81</p> <p>IEC 7005-80</p>	 <p>W2x4.6d IEC 7004-94</p> <p>IEC 7005-94</p>	 <p>W2.1x9.5d IEC 7004-91</p> <p>IEC 7005-91</p>	 <p>W2.5x16d IEC 7004-104</p> <p>IEC 7005-104</p>	 <p>W2.5x16q IEC 7004-104</p> <p>IEC 7005-104</p>	
 <p>BA9s IEC 7004-14</p> <p>Lampholder standard: IEC 7005-12</p>	 <p>BAY9s BAW9s IEC 7004-9</p> <p>IEC 7005-9</p>	 <p>BAX9s IEC 7004-8</p> <p>IEC 7005-8</p>	 <p>BX8.4d</p> <p>IEC 7005-140</p>	 <p>B8.5d</p> <p>IEC 7005-13</p>	 <p>BA15s IEC 7004-11A</p> <p>IEC 7005-13</p>	 <p>BA15d IEC 7004-11A</p> <p>IEC 7005-13</p>
 <p>BAU15s IEC 7004-19</p> <p>Lampholder standard: IEC 7005-13</p>	 <p>BAW15s IEC 7004-11 E</p> <p>IEC 7005-13</p>	 <p>BAY15d IEC 7004-11 B</p> <p>IEC 7005-13</p>	 <p>BAZ15d IEC 7004-11 C</p> <p>IEC 7005-13</p>	 <p>BAW15d IEC 7004-11 E</p> <p>IEC 7005-13</p>	 <p>BA20d IEC 7004-12</p> <p>IEC 7005-14</p>	
 <p>P14.5s IEC 7004-46</p> <p>Lampholder standard: IEC 7005-46</p>	 <p>PX14.5s</p> <p>IEC 7005-5</p>	 <p>PX26d IEC 7004-5</p> <p>IEC 7005-5</p>	 <p>PGJY19-2 PGJY19-5 PGJY19-1</p> <p>IEC 7004-146 IEC 7005-146</p>	 <p>P26.4t</p> <p>IEC 7005-128</p>	 <p>PGJ23t-1</p> <p>IEC 7004-155 IEC 7005-155</p>	



# Type overview by ECE/SAE category

ECE	V	W		Product Reference		ECE	V	W		Product Reference	
-	12	5	-	LEDCBCTRL101	P.34	-	3.6	6	-	LEDIL108	P.114
-	12	21	-	LEDCBCTRL102	P.34	-	4.5	1.5	-	LEDIL201	P.118
-	12	50	-	LEDCBCTRL103	P.34	-	4.5	1.6	-	LEDIL202	P.118
-	12	22/2	-	LEDDL101-SP	P.98	-	4.5	1.5	-	LEDIL203	P.118
-	12	22/2	-	LEDDL101-WD	P.98	-	4.5	0.5	-	LEDIL204	P.118
-	12/24	30/2	-	LEDDL102-SP	P.94	-	4.5	0.5	-	LEDIL205	P.118
-	12/24	30/2	-	LEDDL102-WD	P.98	-	4.5	0.5	-	LEDIL205-PK	P.118
-	12/24	35	-	LEDDL103-SP	P.96	-	4.5	0.5	-	LEDIL205-BKPK	P.118
-	12/24	35	-	LEDDL103-CB	P.96	-	4.5	3	-	LEDIL206	P.118
-	12/24	36	-	LEDDL104-SP	P.96	-	4.5	3	-	LEDIL207	P.118
-	12/24	68	-	LEDDL104-CB	P.96	-	4.5	3	-	LEDIL209	P.118
-	12/24	68	-	LEDDL104-CB SM	P.96	-	12	-	-	LEDINT102	P.108
-	12/24	14	-	LEDDL105-SP	P.96	-	12	-	-	LEDINT103	P.108
-	12/24	29	-	LEDDL106-SP	P.96	-	12	-	-	LEDINT104	P.108
-	12/24	46	-	LEDDL107-SP	P.96	-	12	-	-	LEDINT201	P.108
-	12	2.4	-	LEDDMI 5G0 WT S	P.94	-	12	-	-	LEDINT202	P.108
-	12	2.4	-	LEDDMI 5G0 BK S	P.94	-	12	-	-	LEDINT201-SEC	P.108
-	12	2.4	-	LEDDMI 3G0 WT S	P.94	-	12	-	-	LEDINT203	P.108
-	12	2.4	-	LEDDMI F20 WT S	P.94	-	3	1.7	-	LEDSL101	P.122
-	12	2.4	-	LEDDMI F20 BK S	P.94	-	4.5	0.5	-	LEDSL302	P.122
-	12	15	-	LEDDRL102	P.100	-	12/24	0.5	-	ONYX L-7	P.124
-	12	13.5	-	LEDDRL301 CL15	P.100	-	12/24	0.5	-	ONYX M-7	P.124
-	12	-	-	LEDEXT101	P.108	-	12/24	0.5	-	ONYX USB	P.124
-	12	42	-	LEDEXT102-10	P.108	-	12	2/0.4	BAY15d	1458CW <sup>(1)</sup>	P.28
-	12	51	-	LEDEXT102-04	P.108	-	12	2/0.4	BAY15d	1458R <sup>(1)</sup>	P.28
-	12	60	-	LEDEXT102-03	P.108	-	12	2/0.4	BAY15d	1457YE <sup>(1)</sup>	P.28
-	12/24	7/12	-	LEDFOG102	P.102	-	12	2/0.4	BAY15d	1557CW <sup>(1)</sup>	P.28
-	-	-	-	LEDFOG101-VW-M	P.102	-	12	2/0.4	BAY15d	1557R <sup>(1)</sup>	P.28
-	-	-	-	LEDFOG101-NIS-M	P.102	-	12	2/0.4	BAY15d	1557YE <sup>(1)</sup>	P.28
-	-	-	-	LEDFOG101-INF-M	P.102	-	12	1.2	BX8.4d	2351MFX6	P.63
-	-	-	-	LEDFOG101-TY-M	P.102	-	12	2	BX8.4d	2352MFX6	P.63
-	12	4/12	-	LEDFOG103-SR	P.104	-	12	1.5	BX8.4d	2452MFX6	P.63
-	12	4/12	-	LEDFOG103-BL	P.104	-	12	1.12	BX8.4d	2473MFX6	P.63
-	12	8	-	LEDFOG201	P.104	-	12	6.7	PG20-7	2604CW	P.26
-	-	-	-	FOG103/201-TY-M	P.104	-	12	1.2	W2x4.6d	2721	P.62
-	-	-	-	FOG103/201-VW-M	P.104	-	12	1.2	B8.5d	2721MF	P.63
-	-	-	-	FOG103/201-NIS-M	P.104	-	12	1.2	BX8.5d	2721MFX	P.63
-	12	70	-	LEDHL102-BK	P.92	-	12	2	W2x4.6d	2722	P.62
-	12	70	-	LEDHL102-BK RHD	P.92	-	12	2	B8.5d	2722MF	P.63
-	12	70	-	LEDHL102-CM	P.92	-	12	2	BX8.5d	2722MFX	P.63
-	12	70	-	LEDHL102-GTI	P.92	-	12	2	W2.1x9.5d	2820	P.62
-	12	70	-	LEDHL103-GTI	P.90	-	12	1	W2.1x9.5d	2850BL <sup>(1)</sup>	P.30
-	12	70	-	LEDHL103-BK	P.90	-	12	1	W2.1x9.5d	2850CW <sup>(1)</sup>	P.30
-	12	70	-	LEDHL103-CM	P.90	-	12	1	W2.1x9.5d	2850WW <sup>(1)</sup>	P.30
-	12	70	-	LEDHL104-GTI	P.90	-	12	1	W2.1x9.5d	2855YE <sup>(1)</sup>	P.30
-	12	70	-	LEDHL104-BK	P.90	-	12	1	W2.1x9.5d	2880BL <sup>(1)</sup>	P.30
-	12	70	-	LEDHL104-CM	P.90	-	12	1	W2.1x9.5d	2880CW <sup>(1)</sup>	P.30
-	12	70	-	LEDHL105	P.92	-	12	1	W2.1x9.5d	2880R <sup>(1)</sup>	P.30
-	3.4	3.5	-	LEDIL103	P.114	-	12	1	W2.1x9.5d	2880YE <sup>(1)</sup>	P.30
-	220	13-15	-	LEDIL104	P.114	-	12	1	W2.1x9.5d	2880GR <sup>(1)</sup>	P.30
-	3.7	0.5	-	LEDIL105	P.114	-	12	6	W2.1x9.5d	2886X	P.62
-	3.7	0.5	-	LEDIL106	P.114	-	12	1.8	PG20-1	3301CW <sup>(1)</sup>	P.28
-	3.7	1	-	LEDIL107	P.114	-	12	1.8	PG18.5d-1	3828CW <sup>(1)</sup>	P.28

ECE	V	W		Product Reference	
-	12	1.9	W2.5x9.5d	3548YE <sup>(1)</sup>	P.28
-	12	1.7	W2.5x9.5d	3548CW <sup>(1)</sup>	P.28
-	12	1.7	W2.5x9.5d	3548R <sup>(1)</sup>	P.28
-	12	1.42/0.54	W2.5x16q	3557CW <sup>(1)</sup>	P.28
-	12	1.42/0.54	W2.5x16q	3557R <sup>(1)</sup>	P.28
-	12	1.42/0.54	W2.5x16q	3557YE <sup>(1)</sup>	P.28
-	12	2	BA9s	3796	P.62
-	12	1	BA9s	3850CW <sup>(1)</sup>	P.30
-	12	1	BA9s	3850WW <sup>(1)</sup>	P.30
-	12	5	BA9s	3860	P.62
-	12	3	PG20-1	5301CW <sup>(1)</sup>	P.28
-	12	3	PG18.5d-1	5828CW <sup>(1)</sup>	P.28
-	12	10	SV8.5-8	6411	P.63
-	12	5	SV8.5-8	6413	P.63
-	12	3	SV7-8	6428	P.63
-	12	10	SV8.5-8	6438	P.63
-	12	10	SV8.5-8	6461	P.63
-	12	0.5	SV8.5-8	6431CW <sup>(1)</sup>	P.30
-	12	0.5	SV8.5-8	6431BL <sup>(1)</sup>	P.30
-	12	0.5	SV8.5-8	6436CW <sup>(1)</sup>	P.30
-	12	0.5	SV8.5-8	6436BL <sup>(1)</sup>	P.30
-	12	0.5	SV8.5-8	6441CW <sup>(1)</sup>	P.30
-	12	0.5	SV8.5-8	6441BL <sup>(1)</sup>	P.30
-	12	1	SV8.5-8	6497CW <sup>(1)</sup>	P.30
-	12	1	SV8.5-8	6497WW <sup>(1)</sup>	P.30
-	12	1	SV8.5-8	6498CW <sup>(1)</sup>	P.30
-	12	1	SV8.5-8	6498WW <sup>(1)</sup>	P.30
-	12	1	SV8.5-8	6499CW <sup>(1)</sup>	P.30
-	12	1	SV8.5-8	6499WW <sup>(1)</sup>	P.30
-	12	6	SV8.5-8	6486X	P.63
-	12	21/5	BA15d	7240	P.62
-	12	1.4	BA15s	7458CW <sup>(1)</sup>	P.28
-	12	1.4	BA15s	7458R <sup>(1)</sup>	P.28
-	12	1.3	BA15s	7458YE <sup>(1)</sup>	P.28
-	12	1.3	BAU15s	7459YE <sup>(1)</sup>	P.28
-	12	2	BA15s	7556CW <sup>(1)</sup>	P.28
-	12	2	BA15s	7556R <sup>(1)</sup>	P.28
-	12	2	BA15s	7556YE <sup>(1)</sup>	P.28
-	12	2	BAU15s	7557YE <sup>(1)</sup>	P.28
-	12	1	W3x16d	7706YE <sup>(1)</sup>	P.28
-	12	1.7	W3x16d	7706CW <sup>(1)</sup>	P.28
-	12	1.7	W3x16d	7706R <sup>(1)</sup>	P.28
-	12	1.9	W3x16q	7716YE <sup>(1)</sup>	P.28
-	12	1.7	W3x16q	7716CW <sup>(1)</sup>	P.28
-	12	1.7	W3x16q	7716R <sup>(1)</sup>	P.28
-	12	1.5	W3x16d	7905R <sup>(1)</sup>	P.28
-	12	1.5	W3x16d	7905YE <sup>(1)</sup>	P.28
-	12	3	W3x16d	7905CW <sup>(1)</sup>	P.28
-	12	1.5	W3x16q	7915R <sup>(1)</sup>	P.28
-	12	1.5	W3x16q	7915YE <sup>(1)</sup>	P.28
-	12	3	W3x16q	7915CW <sup>(1)</sup>	P.28
-	12	1.8	W2.1x9.5d	9212CW <sup>(1)</sup>	P.28
-	12	2	W2.1x9.5d	9213R <sup>(1)</sup>	P.28
-	12	3	W2.1x9.5d	9213CW <sup>(1)</sup>	P.28
-	12	13	PY20d	9745CW	P.26
-	12	-	P43t	9726CW	P.24
-	12	-	P22d	9736CW	P.24
-	12	80	P14.5s	62150CBB <sup>(1)</sup>	P.86
-	12	20	BA9s	64111	P.63
-	12	10	BA9s	64113	P.63
-	12	5	BA9s	64115	P.63
-	12	100/90	P43t	62193CBB <sup>(1)</sup>	P.86
-	12	100	P14.5s	62200SBP <sup>(1)</sup>	P.84
-	12	100	PK22s	62201SBP <sup>(1)</sup>	P.84
-	12	100/90	P43t	62204SBP <sup>(1)</sup>	P.84
-	12	80	PX26d	62210CBB <sup>(1)</sup>	P.86
-	12	75	PGJ19-2	62211CBB <sup>(1)</sup>	P.86
-	12	75	PGJ19-5	62213CBB <sup>(1)</sup>	P.86
-	12	80	PX26d	62261SBP <sup>(1)</sup>	P.84
-	12	100	PX14.5s	64152SB <sup>(1)</sup>	P.84
-	12	100	PKX22s	64153SB <sup>(1)</sup>	P.84
-	12	100/90	PU43t	64194SB <sup>(1)</sup>	P.84
-	12	60/55	P45t	64198SB <sup>(1)</sup>	P.84
-	12	100/90	P45t	64204SB <sup>(1)</sup>	P.84
-	12/24	35	PK32d-2	66140CBB <sup>(1)</sup>	P.86
-	12/24	35	P32d-2	66240CBB <sup>(1)</sup>	P.86
-	12/24	35	PK32d-5	66340CBB <sup>(1)</sup>	P.86
-	12/24	35	P32d-5	66440CBB <sup>(1)</sup>	P.86
-	12	-	PX26d	67210CW	P.24
-	12	-	PGJ19-2	67211CW	P.24
-	12	13	PGJ19	67219CW	P.26
-	12	100	P20d	69005SBP <sup>(1)</sup>	P.84
-	12	100	P20d	69005CBB <sup>(1)</sup>	P.86
-	12	80	P22d	69006SBP <sup>(1)</sup>	P.84
-	12	80	P22d	69006CBB <sup>(1)</sup>	P.86
-	24	1	W2x4.6d	2341	P.70
-	24	1.2	W2x4.6d	2741	P.70
-	24	1.2	B8.5d	2741MF	P.70
-	24	1.2	BX8.5d	2741MFX	P.70
-	24	1	W2.1x9.5d	2824CW <sup>(1)</sup>	P.32
-	24	1	W2.1x9.5d	2824WW <sup>(1)</sup>	P.32
-	24	2	W2.1x9.5d	2840	P.70
-	24	2	BA9s	3797	P.70
-	24	1	BA9s	3924WW	P.32
-	24	1	BA9s	3924CW	P.32
-	24	3	SV8.5-8	6421	P.70
-	24	3	SV8.5-8	6430	P.70
-	24	5	SV8.5-8	6424	P.70
-	24	10	SV8.5-8	6429	P.70
-	24	15	BA15s	7529	P.70
C5W	12	5	SV8.5-8	6418	P.63
C5W	12	5	SV8.5-8	6418ULT	P.58
C5W	24	5	SV8.5-8	6423	P.70
D1S	85	35	PK32d-2	66140	P.46
D1S	85	35	PK32d-2	66140XNL	P.40
D1S	85	35	PK32d-2	66140CBI	P.42

ECE	V	W		Product Reference	
D1S	85	35	PK32d-2	66140ULT	P.46
D1R	85	35	PK32d-3	66150	P.46
D1R	85	35	PK32d-3	66150CBI	P.42
D2S	85	35	P32d-2	66240	P.46
D2S	85	35	P32d-2	66240XNL	P.40
D2S	85	35	P32d-2	66240CBI	P.42
D2S	85	35	P32d-2	66240ULT	P.44
D2R	85	35	P32d-3	66250	P.46
D2R	85	35	P32d-3	66250CBI	P.42
D3S	42	35	PK32d-5	66340	P.46
D3S	42	35	PK32d-5	66340XNL	P.40
D3S	42	35	PK32d-5	66340CBI	P.42
D3S	42	35	PK32d-5	66340ULT	P.44
D3R	42	35	PK32d-6	66350	P.46
D4S	42	35	P32d-5	66440	P.46
D4S	42	35	P32d-5	66440XNL	P.40
D4S	42	35	P32d-5	66440CBI	P.42
D4S	42	35	P32d-5	66440ULT	P.44
D4R	42	35	P32d-6	66450	P.46
D5S	12	25	PK32d-7	66540	P.46
D8S	42	25	PK32d-1	66548	P.46
H1	12	55	P14.5s	64150	P.60
H1	12	55	P14.5s	64150NL	P.50
H1	12	55	P14.5s	64150NBS	P.52
H1	12	55	P14.5s	64150CBI	P.54
H1	12	55	P14.5s	64150ULT	P.58
H1	24	70	P14.5s	64155	P.70
H1	24	70	P14.5s	64155TSP	P.72
H10	12	42	PY20d	9145	P.60
H11	12	55	PGJ19-2	64211	P.60
H11	12	55	PGJ19-2	64211NL	P.50
H11	12	55	PGJ19-2	64211NBS	P.52
H11	12	55	PGJ19-2	64211CBI	P.54
H11	12	55	PGJ19-2	64211ULT	P.58
H11	12	55	PGJ19-2	64211NR1	P.76
H11	12	55	PGJ19-2	64211NR5	P.78
H11	12	55	PGJ19-2	64211XR	P.80
H11	24	70	PGJ19-2	64216TSP	P.72
H11B	12	55	PGJY19-2	64241	P.60
H13	12	60/55	P26.4t	9008	P.60
H15	12	55/15	PGJ23t-1	64176	P.60
H15	12	55/15	PGJ23t-1	64176CBI	P.54
H15	24	20/60	PGJ23t-1	64177	P.70
H16	12	19	PGJ19-3	64219L+	P.60
H16	12	19	PGJ19-3	64219CBI	P.54
H18	12	55	PY26d-1	64180L	P.60
H19	12	60/55	PU43t-3	64181L	P.60
H2	12	55	X511	64173	P.60
H2	24	70	X511	64175	P.70
H21W	12	21	BAY9s	64136	P.63
H21W	24	21	BAY9s	64138	P.70
H27W/1	12	27	PG13	880	P.60
H27W/1	12	27	PG13	880CBI	P.54
H27W/2	12	27	PGJ13	881	P.60

ECE	V	W		Product Reference	
H27W/2	12	27	PGJ13	881CBI	P.54
H3	12	55	PK22s	64151	P.60
H3	12	55	PK22s	64151NL	P.50
H3	12	55	PK22s	64151CBI	P.54
H3	24	70	PK22s	64156	P.70
H3	24	70	PK22s	64156TSP	P.72
H4	12	60/55	P43t	64193	P.60
H4	12	60/55	P43t	64193NL	P.50
H4	12	60/55	P43t	64193NBS	P.52
H4	12	60/55	P43t	64193CBI	P.54
H4	12	60/55	P43t	64193ULT	P.58
H4	12	60/55	P43t	64193NR1	P.76
H4	12	60/55	P43t	64193NR5	P.78
H4	12	60/55	P43t	64193XR	P.80
H4	12	60/55	P43t	64193MC	P.80
H4	24	75/70	P43t	64196	P.70
H4	24	75/70	P43t	64196TSP	P.72
H4	24	75/70	P43t	94196	P.70
H6W	12	6	BAX9s	64132	P.63
H6W	12	6	BAX9s	64132ULT	P.58
H7	12	55	PX26d	64210	P.60
H7	12	55	PX26d	64210NL	P.50
H7	12	55	PX26d	64210NBS	P.52
H7	12	55	PX26d	64210CBI	P.54
H7	12	55	PX26d	64210ULT	P.58
H7	12	55	PX26d	64210NR1	P.76
H7	12	55	PX26d	64210NR5	P.78
H7	12	55	PX26d	64210XR	P.80
H7	12	55	PX26d	64210MC	P.80
H7	24	70	PX26d	64215	P.70
H7	24	70	PX26d	64215TSP	P.72
H8	12	35	PGJ19-1	64212	P.60
H8	12	35	PGJ19-1	64212NL	P.50
H8	12	35	PGJ19-1	64212CBI	P.54
H8	12	35	PGJ19-1	64212NR1	P.76
H8	12	35	PGJ19-1	64212XR	P.80
H8B	12	35	PGJY19-1	64242	P.60
H9	12	65	PGJ19-5	64213	P.60
H9B	12	65	PGJY19-5	64243	P.60
HB3	12	60	P20d	9005	P.60
HB3	12	60	P20d	9005NL	P.50
HB3	12	60	P20d	9005CBI	P.54
HB3A	12	60	P20d	9005XS	P.60
HB4	12	51	P22d	9006	P.60
HB4	12	51	P22d	9006NL	P.50
HB4	12	51	P22d	9006CBI	P.54
HB4A	12	51	P20d	9006XS	P.60
HB5	12	65/55	PX29t	9007	P.60
HIR1	12	65	PX20d	9011	P.62
HIR2	12	55	PX22d	9012	P.62
HIR2	12	55	PX22d	9012CBI	P.54
HS1	12	35/35	PX43t	64185	P.80



ECE	V	W		Product Reference	
HS1	12	35/35	PX43t	64185NR9	P.76
HS1	12	35/35	PX43t	64185NR5	P.78
HS1	12	35/35	PX43t	64185XR	P.80
HY21W	12	21	BAW9s	64137ULT	P.58
P21W	12	21	BA15s	7506	P.62
P21W	12	21	BA15s	7506ULT	P.58
P21W	24	21	BA15s	7511	P.70
P21W	24	21	BA15s	7511TSP	P.72
P21/4W	12	21/4	BAZ15d	7225	P.62
P21/5W	12	21/5	BAY15d	7528	P.62
P21/5W	12	21/5	BAY15d	7528ULT	P.58
P21/5W	24	21/5	BAY15d	7537	P.70
P21/5W	24	21/5	BAY15d	7537TSP	P.72
P27W	12	27	W2.5x16d	3156	P.63
P27/7W	12	27/7	W2.5x16q	3157	P.63
PR21W	12	21	BAW15s	7508LDR	P.56
PR21/5W	12	21/5	BAW15d	7538LDR	P.56
PS19W	12	19	PG20-1	5201	P.63
PS24W	12	24	PG20-3	5202	P.63
PSX24W	12	24	PG20-7	2504	P.63
PY21W	12	21	BAU15s	7507	P.62
PY21W	12	21	BAU15s	7507ULT	P.58
PY21W	12	21	BAU15s	7507DC	P.56
PY21W	12	21	BAU15s	7507LDA	P.56
PY21W	24	21	BAU15s	7510TSP	P.72
PY27/7W	12	27/7	WX2.5x16q	3757AK	P.63
R10W	12	10	BA15s	5008	P.63
R10W	12	10	BA15s	5008ULT	P.58
R10W	24	10	BA15s	5637	P.70
R10W	24	10	BA15s	5637TSP	P.72
R2	12	45/40	P45t	64183	P.80
R5W	12	5	BA15s	5007	P.63
R5W	12	5	BA15s	5007ULT	P.58
R5W	24	5	BA15d	5626	P.70
R5W	24	5	BA15s	5627	P.70
R5W	24	5	BA15s	5627TSP	P.72
RY10W	12	10	BAU15s	5009	P.63
S1	12	25/25	BA20d	64326	P.80
S2	12	35/35	BA20d	64327	P.80
S2	12	35/35	BA20d	64327XR	P.80
T4W	12	4	BA9s	3893	P.62
T4W	24	4	BA9s	3930	P.70
T4W	24	4	BA9s	3930TSP	P.72
W16W	12	16	W2.1x9.5d	921	P.62
W2.3W	12	2.3	W2x4.6d	2723	P.63
W21/5W	12	21/5	W3x16q	7515	P.62
W21W	12	21	W3x16d	7505	P.62
W3W	12	3	W2.1x9.5d	2821	P.62

  

ECE	V	W		Product Reference	
W3W	24	3	W2.1x9.5d	2841	P.70
W5W	12	5	W2.1x9.5d	2825	P.62
W5W	12	5	W2.1x9.5d	2825ULT	P.58
W5W	12	5	W2.1x9.5d	2825HCBI	P.54
W5W	24	5	W2.1x9.5d	2845	P.70
W5W	24	5	W2.1x9.5d	2845TSP	P.72
WY5W	12	5	W2.1x9.5d	2827NA	P.62
WY5W	12	5	W2.1x9.5d	2827DC	P.56
WY16W	12	16	W2.1x9.5d	921NA	P.62
WY21W	12	21	WX3x16d	7504	P.62

1) These products do not have ECE approval. This means they must not be used on public roads in any exterior application. Use on public roads leads to cancellation of operating license and loss of insurance coverage. Several countries do not allow sale and use of these products. Please contact your local distributor for information on the availability in your country.

# Type overview in numerical order of product reference with test data

Product Reference	ECE	V	W		V <sub>Test</sub>	W <sub>th</sub>	lm	T <sub>h</sub> <sup>1)</sup> E5/7c	
880	H27W/1	12	27	PG13	13.5	31	450	-	P.60
880CBI	H27W/1	12	27	PG13	13.5	max. 31	477	-	P.54
881	H27W/2	12	27	PGJ13	13.5	31	450	-	P.60
881CBI	H27W/2	12	27	PGJ13	13.5	max. 31	477	-	P.54
921	W16W	12	16	W2.1x9.5d	13.5	19.4	310	400/1000	P.62
921NA	WY16W	12	16	W2.1x9.5d	13.5	19.4	190	400/1000	P.62
1458CW	-	12	2/0.4	BAY15d	13.5	-	150/45	avg: 2000	P.28
1458R	-	12	2/0.4	BAY15d	13.5	-	90/14	avg: 2000	P.28
1458YE	-	12	2/0.4	BAY15d	13.5	-	16/6	avg: 2000	P.28
1557CW	-	12	2/0.4	BAY15d	13.5	-	200/26	2500/5000	P.28
1557R	-	12	2/0.4	BAY15d	13.5	-	118/8	2500/5000	P.28
1557YE	-	12	2/0.4	BAY15d	13.5	-	68/6	2500/5000	P.28
2341	-	24	1	W2x4.6d	28.0	1	3	300/1000	P.70
2351MFX6	-	12	1.2	BX8.4d	13.5	1.32	7.5	600/3000	P.63
2352MFX6	-	12	2	BX8.4d	13.5	2.13	11.8	1500/6000	P.63
2452MFX6	-	12	1.5	BX8.4d	13.5	1.8	6.5	1700/6500	P.63
2473MFX6	-	12	1.12	BX8.4d	14.0	1.12	3.6	500/5000	P.63
2504	PSX24W	12	24	PG20-7	13.5	max. 25	500	500/1000	P.63
2604CW	-	12	6.7	PG20-7	13.2	6.7	730	2500/5000	P.26
2721	-	12	1.2	W2x4.6d	13.5	1.22	7.5	500/2000	P.62
2721MF	-	12	1.2	B8.5d	13.5	1.2	6.4	500/2000	P.63
2721MFX	-	12	1.2	BX8.5d	13.5	1.2	6.4	500/2000	P.63
2722	-	12	2	W2x4.6d	13.5	2	12	1300/4000	P.62
2722MF	-	12	2	B8.5d	13.5	2	10.2	1300/4000	P.63
2722MFX	-	12	2	BX8.5d	13.5	2	10.2	1300/4000	P.63
2723	W2.3W	12	2.3	W2x4.6d	13.5	2.5	18.6	350/1200	P.63
2741	-	24	1.2	W2x4.6d	28.0	1.6	7.5	400/2000	P.70
2741MF	-	24	1.2	B8.5d	28.0	1.6	6.4	400/2000	P.70
2741MFX	-	24	1.2	BX8.5d	28.0	1.6	6.4	400/2000	P.70
2820	-	12	2	W2.1x9.5d	13.5	2.2	13.5	600/4000	P.62
2821	W3W	12	3	W2.1x9.5d	13.5	3	22	1300/4000	P.62
2824CW <sup>2)</sup>	-	24	1	W2.1x9.5d	28	1	55	2500/5000	P.32
2824WW <sup>2)</sup>	-	24	1	W2.1x9.5d	28	1	55	2500/5000	P.32
2825	W5W	12	5	W2.1x9.5d	13.5	5	50	350/1000	P.62
2825HCBI	W5W	12	5	W2.1x9.5d	13.5	5	50	350/1000	P.54
2825ULT	W5W	12	5	W2.1x9.5d	13.5	5	50	700/1500	P.58
2827NA	WY5W	12	5	W2.1x9.5d	13.5	5	30	350/1000	P.62
2827DC	WY5W	12	5	W2.1x9.5d	13.5	5	30	200/500	P.56
2840	-	24	2	W2.1x9.5d	28.0	2.6	13	500/5000	P.70
2841	W3W	24	3	W2.1x9.5d	28.0	4	22	500/5000	P.70
2845	W5W	24	5	W2.1x9.5d	28.0	7	50	800/3000	P.70
2845TSP	W5W	24	5	W2.1x9.5d	28.0	7	50	1000/4000	P.72
2850BL <sup>2)</sup>	-	12	1	W2.1x9.5d	13.5	-	16	5000	P.30
2850CW <sup>2)</sup>	-	12	1	W2.1x9.5d	13.5	-	70	2500/5000	P.30
2850WW <sup>2)</sup>	-	12	1	W2.1x9.5d	13.5	-	55	2500/5000	P.30
2855YE <sup>2)</sup>	-	12	1	W2.1x9.5d	13.5	-	30	2500/5000	P.30
2880BL <sup>2)</sup>	-	12	0.5	W2.1x9.5d	13.5	-	9	avg: 2000	P.30
2880CW <sup>2)</sup>	-	12	0.5	W2.1x9.5d	13.5	-	45	avg: 2000	P.30
2880YE <sup>2)</sup>	-	12	1	W2.1x9.5d	13.5	-	7	avg: 2000	P.30
2880GR <sup>2)</sup>	-	12	0.5	W2.1x9.5d	13.5	-	17	avg: 2000	P.30

Product Reference	ECE	V	W		V <sub>Test</sub>	W <sub>In</sub>	lm	T[h] B3/Tc 1)	
2886X	-	12	6	W2.1x9.5d	13.5	6	85	400/1000	P.62
2880R <sup>2)</sup>	-	12	0.5	W2.1x9.5d	13.5	-	17	avg: 2000	P.30
3156	P27W	12	27	W2.5x16d	13.5	29.2	475	600/0	P.63
3157	P27/7W	12	27/7	W2.5x16q	13.5	29.2/7.7	475/36	600/5000	P.63
3301CW	-	12	1.8	PG20-1	13.5	-	-	-	P.28
3548CW	-	12	2.5	W2.5x16q	13.5	-	150/45	avg: 2000	P.28
3548R	-	12	3	W2.5x16q	13.5	-	90/14	avg: 2000	P.28
3548YE	-	12	1	W2.5x16q	13.5	-	16/6	avg: 2000	P.28
3557CW	-	12	1.42/0.54	W2.5x16q	13.5	-	200/26	2500/5000	P.28
3557R	-	12	1.42/0.54	W2.5x16q	13.5	-	118/8	2500/5000	P.28
3557YE	-	12	1.42/0.54	W2.5x16q	13.5	-	68/6	2500/5000	P.28
3757AK	PY27/7W	12	27/7	WX2.5x16q	13.5	29.2/17.7	280/21	460/1100	P.63
3796	-	12	2	BA9s	13.5	2	12.5	300/750	P.62
3797	-	24	2	BA9s	28	3	17.5	1000/2000	P.70
3828CW	-	12	1.8	PG18.5d-1	13.5	-	-	-	P.28
3850CW <sup>2)</sup>	-	12	1	BA9s	13.2	-	50	500/1000	P.30
3850WW <sup>2)</sup>	-	12	1	BA9s	13.2	-	50	500/1000	P.30
3860	-	12	5	BA9s	13.5	5	50	400/1000	P.62
3893	T4W	12	4	BA9s	13.5	4	35	600/1200	P.62
3924WW <sup>2)</sup>	-	24	1	BA9s	-	-	-	-	P.32
3924CW <sup>2)</sup>	-	24	1	BA9s	-	-	-	-	P.32
3930	T4W	24	4	BA9s	28.0	5	35	250/500	P.70
3930TSP	T4W	24	4	BA9s	28.0	5	35	550/1000	P.72
5007	R5W	12	5	BA15s	13.5	5	50	350/800	P.63
5007ULT	R5W	12	5	BA15s	13.5	5	50	600/1200	P.58
5008	R10W	12	10	BA15s	13.5	10	125	350/800	P.63
5008ULT	R10W	12	10	BA15s	13.5	10	125	600/1200	P.58
5009	RY10W	12	10	BAU15s	13.5	10	75	350/800	P.63
5201	PS19W	12	19	PG20-1	13.5	max. 20	350	500/1000	P.63
5202	PS24W	12	24	PG20-3	13.5	max. 25	500	500/1000	P.63
5301CW	-	12	3	PG20-1	13.5	-	-	-	P.28
5626	R5W	24	5	BA15d	28.0	7	50	80/250	P.70
5627	R5W	24	5	BA15s	28.0	7	50	500/1000	P.70
5627TSP	R5W	24	5	BA15s	28.0	7	50	800/2000	P.72
5637	R10W	24	10	BA15s	28.0	12.5	125	400/800	P.70
5637TSP	R10W	24	10	BA15s	28.0	12.5	125	1000/2000	P.72
5828CW	-	12	3	PG18.5d-1	13.5	-	-	-	P.30
6411	-	12	10	SV8.5-8	13.5	10	100	500/1000	P.63
6413	-	12	5	SV8.5-8	13.5	5	45	1000/2000	P.63
6418	C5W	12	5	SV8.5-8	13.5	5	45	1000/2000	P.63
6418ULT	C5W	12	5	SV8.5-8	13.5	5	45	1500/4000	P.58
6421	-	24	3	SV8.5-8	24.0	3	17	800/1500	P.70
6423	C5W	24	5	SV8.5-8	28.0	7	45	1500/4000	P.70
6424	-	24	5	SV8.5-8	28.0	7	60	1000/2000	P.70
6428	-	12	3	SV7-8	13.5	3.5	29	600/1200	P.63
6429	-	24	10	SV8.5-8	28.0	10	105	300/600	P.70
6430	-	24	3	SV7-8	28.0	3	23	400/800	P.70
6431CW <sup>2)</sup>	-	12	0.5	SV8.5-8	13.5	-	30	avg: 2000	P.30
6431BL <sup>2)</sup>	-	12	0.5	SV8.5-8	13.5	-	4	avg: 2000	P.30
6436CW <sup>2)</sup>	-	12	0.5	SV8.5-8	13.5	-	30	avg: 2000	P.30
6436BL <sup>2)</sup>	-	12	0.5	SV8.5-8	13.5	-	4	avg: 2000	P.30
6438	-	12	10	SV8.5-8	13.0	10	120	200/500	P.63
6441CW <sup>2)</sup>	-	12	0.5	SV8.5-8	13.5	-	30	avg: 2000	P.30
6441BL <sup>2)</sup>	-	12	0.5	SV8.5-8	13.5	-	4	avg: 2000	P.30
6461	-	12	10	SV8.5-8	13.5	10	105	600/1200	P.63
6486X	-	12	6	SV8.5-8	13.5	6	85	350/600	P.63

Product Reference	ECE	V	W		V Test	W In	lm	T[h] B3/Tc 1)	
6497CW <sup>2)</sup>	-	12	1	SV8.5-8	13.5	max. 1.3	35	2500/5000	P.30
6497WW <sup>2)</sup>	-	12	1	SV8.5-8	13.5	max. 1.3	35	2500/5000	P.30
6498CW <sup>2)</sup>	-	12	1	SV8.5-8	13.5	max. 1.3	30	2500/5000	P.30
6498WW <sup>2)</sup>	-	12	1	SV8.5-8	13.5	max. 1.3	30	2500/5000	P.30
6499CW <sup>2)</sup>	-	12	1	SV8.5-8	13.5	max. 1.3	35	2500/5000	P.30
6499WW <sup>2)</sup>	-	12	1	SV8.5-8	13.5	max. 1.3	35	2500/5000	P.30
7225	P21/4W	12	21/4	BAZ15d	13.5	25/5	440/15	180/1250 //290/4000	P.62
7240	-	12	21/5	BA15d	13.5	25/6	440/35	180/1250//290/4000	P.62
7458CW	-	12	2	BA15s	13.5	-	190	avg: 2000	P.28
7458R	-	12	2	BA15s	13.5	-	107	avg: 2000	P.28
7458YE	-	12	2	BA15s	13.5	-	22	avg: 2000	P.28
7459YE	-	12	2	BAU15s	13.5	-	22	avg: 2000	P.28
7504	WY21W	12	21	WX3x16d	13.5	25	280	400/600	P.62
7505	W21W	12	21	W3x16d	13.5	25	460	400/600	P.62
7506	P21W	12	21	BA15s	13.5	25	460	250/500	P.62
7506ULT	P21W	12	21	BA15s	13.5	25	460	500/1000	P.58
7507	PY21W	12	21	BAU15s	13.5	25	280	250/500	P.62
7507ULT	PY21W	12	21	BAU15s	13.5	25	280	500/1000	P.58
7507DC	PY21W	12	21	BAU15s	13.5	25	280	100/250	P.56
7507LDA	PY21W	12	21	BAU15s	13.5	25	280	100/250	P.56
7508LDR	PR21W	12	21	BAW15s	13.5	25	110	500/1000	P.56
7510TSP	PY21W	24	21	BAU15s	28.0	28	250	250/500	P.72
7511	P21W	24	21	BA15s	28.0	28	460	200/400	P.70
7511TSP	P21W	24	21	BA15s	28.0	28	460	250/500	P.72
7515	W21/5W	12	21/5	W3x16q	13.5	25/6	440/35	400/600//3000/3000	P.62
7528	P21/5W	12	21/5	BAY15d	13.5	25/6	440/35	180/1250//290/4000	P.62
7528ULT	P21/5W	12	21/5	BAY15d	13.5	25/6	440/35	300/3000//800/6000	P.58
7529	-	24	15	BA15s	28.0	15	210	100/300	P.70
7537	P21/5W	24	21/5	BAY15d	28.0	28/10	440/40	60/600//160/1600	P.70
7537TSP	P21/5W	24	21/5	BAY15d	28.0	28/10	440/40	100/1000//200/2000	P.72
7538LDR	PR21/5W	12	21/5	BAW15d	13.5	25/6	105/8	300/3000//800/6000	P.56
7556CW	-	12	2	BA15s	13.5	-	200	2500/5000	P.28
7556R	-	12	2	BA15s	13.5	-	115	2500/5000	P.28
7556YE	-	12	2	BA15s	13.5	-	68	2500/5000	P.28
7557YE	-	12	2	BAU15s	13.5	-	68	2500/5000	P.28
7706CW	-	12	2.5	W3x16d	13.5	-	190	avg: 2000	P.28
7706R	-	12	3	W3x16d	13.5	-	107	avg: 2000	P.28
7706YE	-	12	1	W3x16d	13.5	-	22	avg: 2000	P.28
7716CW	-	12	3	W3x16q	13.5	-	150/45	avg: 2000	P.28
7716R	-	12	1.5	W3x16q	13.5	-	90/14	avg: 2000	P.28
7716YE	-	12	1.5	W3x16q	13.5	-	16/6	avg: 2000	P.28
7905CW	-	12	3	W3x16d	13.5	-	230	2500/5000	P.28
7905R	-	12	1.5	W3x16d	13.5	-	50	2500/5000	P.28
7905YE	-	12	1.5	W3x16d	13.5	-	40	2500/5000	P.28
7915CW	-	12	3	W3x16q	13.5	-	170/50	2500/5000	P.28
7915R	-	12	1.5	W3x16q	13.5	-	40/12	2500/5000	P.28
7915YE	-	12	1.5	W3x16q	13.5	-	35/7	2500/5000	P.28
9005	HB3	12	60	P20d	13.2	73	1860	280/550	P.60
9005NL	HB3	12	60	P20d	13.2	73	1860	110/210	P.50
9005CBI	HB3	12	60	P20d	13.2	73	1860	110/220	P.54
9005XS	HB3A	12	60	P20d	13.2	max. 73	1860	-	P.60
9006	HB4	12	51	P22d	13.2	62	1095	860/1720	P.60
9006NL	HB4	12	51	P22d	13.2	62	1095	270/500	P.50
9006CBI	HB4	12	51	P22d	13.2	62	1095	260/520	P.54
9006XS	HB4A	12	51	P20d	13.2	62	1095	860/1720	P.60
9007	HB5	12	65/55	PX29t	12.8	70/60	1350/1000	250/500	P.60

Product Reference	ECE	V	W		V Test	W In	lm	T[h] B3/Tc 1)	P.60
9008	H13	12	60/55	P26.4t	13.2	75/68	1700/1100	170/1290//350/2590	P.60
9011	HIR1	12	65	PX20d	13.2	max. 73	2500	220/300	P.62
9012	HIR2	12	55	PX22d	13.2	max. 63	1875	500/870	P.62
9012CBI	HIR2	12	55	PX22d	13.2	63	1875	300/500	P.54
9145	H10	12	42	PY20d	13.2	50	850	860/1720	P.60
9212CW	-	12	1.8	W2.1x9.5d	12	13	140	-	P.28
9213CW	-	12	3	W2.1x9.5d	13.5	-	230	2500/5000	P.28
9213R	-	12	2	W2.1x9.5d	13.5	-	95	2500/5000	P.28
9745CW	-	12	13	PY20d	-	-	730	-	P.26
9726CW	-	12	-	P43t	-	-	-	-	P.24
9736CW	-	12	-	P22t	-	-	-	-	P.24
62150CBB <sup>2)</sup>	-	12	80	P14.5s	13.2	80	1150	75/150	P.88
62193CBB <sup>2)</sup>	-	12	100/90	P43t	13.2	100/90	1600/760	60/200//120/400	P.88
62200SBP <sup>2)</sup>	-	12	100	P14.5s	13.2	max. 94	2600	23/50	P.84
62201SBP <sup>2)</sup>	-	12	100	PK22s	13.2	max. 95	2300	22/50	P.84
62204SBP <sup>2)</sup>	-	12	100/90	P43t	13.2	100/90	2900/1530	100/200//300/550	P.84
62210CBB <sup>2)</sup>	-	12	80	PX26d	13.2	80	1100	150/350	P.86
62211CBB <sup>2)</sup>	-	12	75	PGJ19-2	13.2	75	1000	200/400	P.86
62213CBB <sup>2)</sup>	-	12	75	PGJ19-5	13.2	75	1100	200/400	P.86
62261SBP <sup>2)</sup>	-	12	80	PX26d	13.2	80	1950	250/500	P.84
64111	-	12	5	BA9s	13.5	5	80	150/500	P.63
64113	-	12	10	BA9s	13.5	10	200	150/400	P.63
64115	-	12	20	BA9s	13.5	22.5	450	150/500	P.63
64132	H6W	12	6	BAX9s	13.5	7	125	350/700	P.63
64132ULT	H6W	12	6	BAX9s	13.5	7	125	600/1000	P.58
64136	H21W	12	21	BAY9s	13.5	25	600	300/600	P.63
64137ULT	HY21W	12	21	BAW9s	13.5	26.25	300	400/700	P.58
64138	H21W	24	21	BAY9s	28.0	28	600	150/400	P.70
64150	H1	12	55	P14.5s	13.2	68	1550	400/650	P.60
64150NL	H1	12	55	P14.5s	13.2	68	1550	150/300	P.50
64150NBS	H1	12	55	P14.5s	13.2	68	1550	250/450	P.52
64150CBI	H1	12	55	P14.5s	13.2	68	1550	150/250	P.54
64150ULT	H1	12	55	P14.5s	13.2	68	1550	1200/2000	P.58
64151	H3	12	55	PK22s	13.2	68	1450	400/650	P.60
64151NL	H3	12	55	PK22s	13.2	68	1450	150/300	P.50
64151CBI	H3	12	55	PK22s	13.2	68	1300	150/250	P.54
64152SB <sup>2)</sup>	-	12	100	PX14,5s	13.2	93	2600	22.5/50	P.84
64153SB <sup>2)</sup>	-	12	100	PKX22s	13.2	85	2300	23/50	P.84
64155	H1	24	70	P14.5s	28.0	84	1900	400/650	P.70
64155TSP	H1	24	70	P14.5s	28.0	84	1900	600/1200	P.72
64156	H3	24	70	PK22s	28.0	84	1750	400/650	P.70
64156TSP	H3	24	70	PK22s	28.0	max. 84	1750	600/1200	P.72
64173	H2	12	55	X511	13.2	68	1800	90/250	P.60
64175	H2	24	70	X511	28.0	84	2150	90/250	P.70
64176	H15	12	55/15	PGJ23t-1	13.2	19/64	260/1350	2000/250//4000/500	P.60
64176CBI	H15	12	55/15	PGJ23t-1	13.2	max. 19/64	260/1350	1000/100//2000/200	P.54
64177	H15	24	20/60	PGJ23t-1	28.0	max. 84	300/1500	1500/200//3000/400	P.70
64180L	H18	12	55	PY26d-1	13.2	max. 69	1700	700/1100	P.60
64181L	H19	12	60/55	PU43t-3	13.2	max. 68/72	1750/1200	300/600//800/1600	P.60
64183	R2	12	45/40	P45t	13.2	48.5/46.5	1030/740	250/400//500/1200	P.80
64185	HS1	12	35/35	PX43t	13.2	36.8/36.8	820/520	75/150//150/300	P.80
64185NR9	HS1	12	35/35	PX43t	13.2	35/35	825/525	75/120//120/240	P.76
64185NR5	HS1	12	35/35	PX43t	13.2	36.8/36.8	820/520	75/120//120/240	P.78
64185XR	HS1	12	35/35	PX43t	13.2	35/35	825/525	75/120//120/240	P.80
64193	H4	12	60/55	P43t	13.2	75/68	1650/1000	250/400//500/900	P.60
64193NL	H4	12	60/55	P43t	13.2	75/68	1650/1000	80/200//160/400	P.50

Product Reference	ECE	V	W		V Test	W In	lm	T[h] B3/Tc 1)	
64193NBS	H4	12	60/55	P43t	13.2	75/68	1650/1000	250/400//450/700	P.52
64193CBI	H4	12	60/55	P43t	13.2	75/68	1650/1000	50/200//100/400	P.54
64193ULT	H4	12	60/55	P43t	13.2	75/68	1650/1000	300/2000//700/3000	P.58
64193NR1	H4	12	60/55	P43t	13.2	75/68	1650/1000	80/260//160/400	P.76
64193NR5	H4	12	60/55	P43t	13.2	75/68	1650/1000	250/400//450/700	P.70
64193MC	H4	12	60/55	P43t	13.2	75/68	1650/1000	250/400//500/900	P.80
64193XR	H4	12	60/55	P43t	13.2	75/68	1650/1000	50/180//100/380	P.80
64194SB <sup>2)</sup>	-	12	100/90	PU43t	13.2	109/85	2900/1500	45/85//85/170	P.84
64196	H4	24	75/70	P43t	28.0	85/80	1900/1200	170/350//400/800	P.70
64196TSP	H4	24	75/70	P43t	28.0	85/80	1900/1200	140/450//300/1000	P.72
64198SB <sup>2)</sup>	-	12	60/55	P45t	13.2	75/68	1650/1000	250/400//500/900	P.84
64204SB <sup>2)</sup>	-	12	100/90	P45t	13.2	99/88	2200/1500	150/300	P.84
64210	H7	12	55	PX26d	13.2	58	1500	330/550	P.60
64210NL	H7	12	55	PX26d	13.2	58	1500	150/250	P.50
64210NBS	H7	12	55	PX26d	13.2	58	1500	250/450	P.52
64210CBI	H7	12	55	PX26d	13.2	58	1500	100/200	P.54
64210ULT	H7	12	55	PX26d	13.2	58	1500	1000/1500	P.58
64210NR1	H7	12	55	PX26d	13.2	58	1500	150/250	P.76
64210NR5	H7	12	55	PX26d	13.2	58	1500	250/450	P.78
64210XR	H7	12	55	PX26d	13.2	58	1500	100/200	P.80
64210MC	H7	12	55	PX26d	13.2	58	1500	330/550	P.80
64211	H11	12	55	PGJ19-2	13.2	62	1350	350/580	P.60
64211NL	H11	12	55	PGJ19-2	13.2	62	1350	150/250	P.50
64211NBS	H11	12	55	PGJ19-2	13.2	62	1350	250/450	P.52
64211CBI	H11	12	55	PGJ19-2	13.2	62	1350	100/200	P.54
64211ULT	H11	12	55	PGJ19-2	13.2	62	1350	1000/2000	P.58
64211NR1	H11	12	55	PGJ19-2	13.2	62	1350	150/250	P.76
64211NR5	H11	12	55	PGJ19-2	13.2	62	1350	250/450	P.78
64211XR	H11	12	55	PGJ19-2	13.2	62	1350	100/200	P.80
64212	H8	12	35	PGJ19-1	13.2	43	800	400/800	P.60
64212NL	H8	12	35	PGJ19-1	13.2	max. 43	800	250/500	P.50
64212CBI	H8	12	35	PGJ19-1	13.2	43	800	250/500	P.54
64212NR1	H8	12	35	PGJ19-1	13.2	43	800	250/500	P.76
64212XR	H8	12	35	PGJ19-1	13.2	43	800	250/500	P.80
64213	H9	12	65	PGJ19-5	13.2	73	2100	250/500	P.60
64215	H7	24	70	PX26d	28.0	75	1750	220/500	P.70
64215TSP	H7	24	70	PX26d	28.0	75	1750	500/1000	P.72
64216TSP	H11	24	70	PGJ19-2	28.0	max. 80	1600	500/1000	P.72
64219CBI	H16	12	19	PGJ19-3	13.2	max. 26	500	250/500	P.54
64219L+	H16	12	19	PGJ19-3	13.2	26	500	1115/2000	P.60
64241	H11B	12	55	PGJY19-2	13.2	62	1350	350/580	P.60
64242	H8B	12	35	PGJY19-1	13.2	43	800	400/800	P.60
64243	H9B	12	65	PGJY19-5	13.2	73	2100	250/500	P.60
64326	S1	12	25/25	BA20d	13.5	25/25	430/310	-	P.80
64327	S2	12	35/35	BA20d	13.5	35/35	650/460	80/160	P.80
64327XR	S2	12	35/35	BA20d	13.5	35/35	650/465	75/150//120/300	P.80
66140	D1S	85	35	PK32d-2	13.5	35	3200	2000/3000	P.46
66140XNL	D1S	85	35	PK32d-2	13.5	35	3200	1500/3000	P.40
66140CBI	D1S	85	35	PK32d-2	13.5	35	3200	1500/3000	P.42
66140ULT	D1S	85	35	PK32d-2	13.5	35	3200	-	P.44
66140CBB <sup>2)</sup>	-	85	35	PK32d-2	13.2	35	3200	600/1500	P.86
66150	D1R	85	35	PK32d-3	13.5	35	2800	2000/3000	P.46
66150CBI	D1R	85	35	PK32d-3	13.5	35	2800	1500/3000	P.42
66240	D2S	85	35	P32d-2	13.5	35	3200	2000/3000	P.46
66240XNL	D2S	85	35	P32d-2	13.5	35	3200	1500/3000	P.40
66240CBI	D2S	85	35	P32d-2	13.5	35	3200	1800/2800	P.42

Product Reference	ECE	V	W		V <sub>Test</sub>	W <sub>In</sub>	lm	T[h] B3/Tc 1)	
66240ULT	D2S	85	35	P32d-2	13.5	35	3200	-	P.44
66240CBB <sup>2)</sup>	-	85	35	P32d-2	13.2	35	3200	600/1500	P.86
66250	D2R	85	35	P32d-3	13.5	35	2800	2000/3000	P.46
66250CBI	D2R	85	35	P32d-3	13.5	35	2800	1500/2000	P.42
66340	D3S	42	35	PK32d-5	13.5	35	3200	2000/4000	P.46
66340XNL	D3S	42	35	PK32d-5	13.5	35	3200	2000/3000	P.40
66340CBI	D3S	42	35	PK32d-5	13.5	35	3200	2000/3000	P.42
66340ULT	D3S	42	35	PK32d-5	13.5	35	3200	-	P.44
66340CBB <sup>2)</sup>	-	85	35	PK32d-5	13.2	35	3200	-	P.86
66350	D3R	42	35	PK32d-6	13.5	35	2800	2000/3000	P.46
66440	D4S	42	35	P32d-5	13.5	35	3200	2000/4000	P.46
66440XNL	D4S	42	35	P32d-5	13.5	35	3200	2000/3000	P.40
66440CBI	D4S	42	35	P32d-5	13.5	35	3200	2000/3000	P.42
66440ULT	D4S	42	35	P32d-5	13.5	35	3200	-	P.44
66440CBB <sup>2)</sup>	-	85	35	P32d-5	13.2	35	3200	-	P.86
66450	D4R	42	35	P32d-6	13.5	35	2800	2000/3000	P.46
66540	D5S	12	25	PK32d-7	13.2	25	2000	2500/4000	P.46
66548	D8S	42	25	PK32d-1	13.5	25	2000	2500/4000	P.46
67210CW	-	12	-	PX26d	-	-	-	-	P.24
67211CW	-	12	-	PGJ19-2	-	-	-	-	P.24
67219CW	-	12	13	PGJ19	12	13	730	-	P.26
69005SBP <sup>2)</sup>	-	12	100	P20d	13.2	100	2885	280/550	P.84
69005CBB <sup>2)</sup>	-	12	100	P20d	13.2	100	1100	350/700	P.86
69006SBP <sup>2)</sup>	-	12	80	P22d	13.2	max. 80	1890	600/1200	P.84
69006CBB <sup>2)</sup>	-	12	80	P22d	13.2	80	900	300/600	P.86
94196	H4	24	75/70	P43t	28.0	85/80	1900/1200	170/500//400/1500	P.70
LEDCBCTRL101	-	12	5	-	-	-	-	-	P.34
LEDCBCTRL102	-	12	21	-	-	-	-	-	P.34
LEDCBCTRL103	-	12/24	50	-	-	-	-	-	P.34
LEDDL101-SP	-	12/24	22/2	-	13.5	22/2	1250	5000	P.98
LEDDL101-WD	-	12/24	22/2	-	13.5	22/2	1250	5000	P.98
LEDDL102-SP	-	12/24	30/2	-	13.5	30/2	2000	5000	P.96
LEDDL102-WD	-	12/24	30/2	-	13.5	30/2	2000	5000	P.98
LEDDL103-SP	-	12/24	35	-	13.2	35	2700	5000	P.96
LEDDL103-CB	-	12/24	35	-	13.2	35	2700	5000	P.96
LEDDL104-SP	-	12/24	36	-	13.2	36	4600	5000	P.96
LEDDL104-CB	-	12/24	68	-	13.2	36	4600	5000	P.96
LEDDL104-CB SM	-	12/24	68	-	13.2	36	4600	5000	P.96
LEDDL105-SP	-	12/24	14	-	13.2	14	1300	5000	P.96
LEDDL106-SP	-	12/24	29	-	13.2	29	2600	5000	P.96
LEDDL107-SP	-	12/24	46	-	13.2	46	3900	5000	P.96
LEDDMI 5G0 WT S	-	12	2.4	-	13.2	2.4	-	5000	P.94
LEDDMI 5G0 BK S	-	12	2.4	-	13.2	2.4	-	5000	P.94
LEDDMI 3G0 WT S	-	12	2.4	-	13.2	2.4	-	5000	P.94
LEDDMI F20 WT S	-	12	4.56	-	13.2	4.56	-	5000	P.94
LEDDMI F20 BK S	-	12	4.56	-	13.2	4.56	-	5000	P.94
LEDDRL102	-	12	15	-	14.0	15	300	5000	P.100
LEDDRL301CL15	-	12	13.5	-	14.0	13.5	300	5000	P.100
LEDEXT101	-	12	-	-	-	-	-	-	P.108
LEDEXT102-03	-	12	60	P20d	-	-	-	-	P.108
LEDEXT102-04	-	12	51	P22d	-	-	-	-	P.108
LEDEXT102-10	-	12	42	PY20d	-	-	-	-	P.108
LEDFOG102	-	12/24	7/10	-	14.0/28.0	FOG 7/DRL 10	-	0/5000	P.102
LEDFOG101-TY-M	-	-	-	-	-	-	-	0/5000	P.102
LEDFOG101-VW-M	-	-	-	-	-	-	-	0/5000	P.102
LEDFOG101-NIS-M	-	-	-	-	-	-	-	0/5000	P.102

Product Reference	ECE	V	W		V <sub>Test</sub>	W <sub>En</sub>	Im	T[h] B3/Tc 1)	
LEDFOG101-INF-M -	-	-	-	-	-	-	-	0/5000	P.102
LEDFOG103-SR -	-	12	4x2/12x2	-	14	FOG 4/DRL 12	-	0/5000	P.104
LEDFOG103-BL -	-	12	4x2/12x2	-	14	FOG 4/DRL 12	-	0/5000	P.104
LEDFOG201 -	-	12	8	-	14.0	8	-	0/5000	P.104
FOG103/201-TY-M -	-	-	-	-	-	-	-	-	P.104
FOG103/201-VW-M -	-	-	-	-	-	-	-	-	P.104
FOG103/201-NIS-M -	-	-	-	-	-	-	-	-	P.104
LEDHL102-BK -	-	12	70	-	-	-	-	-	P.92
LEDHL102-BK RHD -	-	12	70	-	-	-	-	-	P.92
LEDHL102-CM -	-	12	70	-	-	-	-	-	P.92
LEDHL102-GTI -	-	12	70	-	-	-	-	-	P.92
LEDHL103-BK -	-	12	-	-	-	-	-	-	P.90
LEDHL103-CM -	-	12	-	-	-	-	-	-	P.90
LEDHL103-GTI -	-	12	-	-	-	-	-	-	P.90
LEDHL104-BK -	-	12	-	-	-	-	-	-	P.90
LEDHL104-CM -	-	12	-	-	-	-	-	-	P.90
LEDHL104-GTI -	-	12	-	-	-	-	-	-	P.90
LEDHL105 -	-	12	70	-	-	-	-	-	P.92
LEDIL103 -	-	3.4	3.5	-	-	-	280	6000	P.114
LEDIL104 -	-	220	13-15	-	90-250	13-15	1.400	-	P.114
LEDIL105 -	-	3.4	3.5	-	3.7	0.5	150/35	-	P.114
LEDIL106 -	-	3.4	3.5	-	3.7	0.5	150	-	P.114
LEDIL107 -	-	3.4	3.5	-	3.7	1	280/70	-	P.114
LEDIL108 -	-	3.6	6	-	-	-	-	-	P.114
LEDIL201 -	-	4.5	1.5	-	-	-	80/25	5000	P.118
LEDIL202 -	-	4.5	1.6	-	-	-	125/90	5000	P.118
LEDIL203 -	-	4.5	1.5	-	-	-	80	5000	P.118
LEDIL204 -	-	3.7	0.5	-	-	-	160/75	6500	P.118
LEDIL205 -	-	3.6	0.5	-	-	-	15	6500	P.118
LEDIL205-PK -	-	3.6	0.5	-	-	-	15	6500	P.118
LEDIL205-BKPK -	-	3.6	0.5	-	-	-	15	6500	P.118
LEDIL206 -	-	3.7	3	-	-	-	250/30	6500	P.118
LEDIL207 -	-	3.7	3	-	-	-	150/70	6500	P.118
LEDIL209 -	-	4.5	3	-	-	-	300/60	6500	P.118
LEDINT102 -	-	12	-	-	-	-	-	-	P.108
LEDINT103 -	-	12	-	-	-	-	-	-	P.108
LEDINT104 -	-	12	-	-	-	-	-	-	P.108
LEDINT201 -	-	12	-	-	-	-	-	-	P.110
LEDINT202 -	-	12	-	-	-	-	-	-	P.110
LEDINT201-SEC -	-	12	-	-	-	-	-	-	P.110
LEDINT203 -	-	12	-	-	-	-	-	-	P.110
LEDSL101 -	-	3	1.7	-	-	-	-	-	P.122
LEDSL302 -	-	4.5	0.5	-	-	-	-	-	P.122
ONYX-USB -	-	12/24	0.5	-	-	0.5	20	-	P.124
ONYX L-7 -	-	12/24	0.5	-	-	0.5	20	-	P.124
ONYX M-7 -	-	12/24	0.5	-	-	0.5	20	-	P.124

1) What do B3 and Tc mean in connection with the service life of bulbs? If we consider the service lives of products that are designed to last a certain time, we can see that they all have identical or similar failure characteristics. If we plot the service lives of the individual bulbs on special logarithmic graph paper, the graph produced is called a "Weibull distribution curve". In a stable production process, we obtain a straight line for the service life via which we can read off various life values. For its products in the automotive sector, OSRAM specifies a B3 value, which indicates the time at which 3% of the tested bulbs have failed. OSRAM also specifies the Tc value (characteristic Weibull value), which indicates the time at which 63.2% of the bulbs have failed. Formerly, only the average value was specified (the average life), which in this system would correspond to a B50 value (i.e. the time at which 50% of the bulbs have failed). By specifying both the B3 value and the Tc value it is possible to get an idea of the spread of the product's service life and hence the quality of the product.

Explanation: single filament lamp e.g. 100/300 | dual filament lamp e.g.  $\underbrace{100/300}_{B_3} / \underbrace{500/100}_{T_c}$

2) These products do not have ECE approval. This means they must not be used on public roads in any exterior application. Use on public roads leads to cancellation of operating license and loss of insurance coverage. Several countries do not allow sale and use of these products. Please contact your local distributor for information on the availability in your country



# Regional EAN overview

The new packaging reflects specific regional requirements by offering regionalized variants with a dedicated EAN.

Region 1 = WEST-MEA    Region 2 = CIS    Region 3 = EASTIC    Region 4 = LATAM    Region 5 = EMEA

COUNTRY	REGION LED + VAP Blister, DUO BOX	REGION ORIGINAL Blister	COUNTRY	REGION LED + VAP blister, DUO BOX	REGION ORIGINAL Blister	COUNTRY	REGION LED + VAP blister, DUO BOX	REGION ORIGINAL Blister	COUNTRY	REGION LED + VAP blister, DUO BOX	REGION ORIGINAL Blister
Albania	■	■	Democratic Republic of Congo	■		Lebanon	■	■	São Tomé and Príncipe	■	
Algeria	■	■	Denmark	■	■	Lesotho	■		Saudi Arabia	■	■
Andorra	■		Dominica	■		Liberia	■		Senegal	■	
Angola	■	■	Dominican Republic	■		Libya	■	■	Serbia	■	■
Antigua and Barbuda	■		Gabon	■		Liechtenstein	■		Seychelles	■	
Equatorial Guinea	■		Gambia	■		Lithuania	■	■	Sierra Leone	■	
Argentina	■		Ghana	■		Macedonia	■	■	Slovakia	■	■
Armenia	■	■	Grenada	■		Madagascar	■		Slovenia	■	■
Austria	■	■	Georgia	■	■	Malawi	■		Somalia	■	
Azerbaijan	■	■	Germany	■	■	Mali	■		South Africa	■	■
Bahamas	■		Greece	■	■	Malta	■		South Sudan	■	
Bahrain	■	■	Guatemala	■		Mauretania	■		Spain	■	■
Barbados	■		Guinea	■		Mauritius	■		Sudan	■	
Belarus	■	■	Guinea-Bissau	■		Monaco	■		Suriname	■	
Belize	■		Guyana	■		Morocco	■	■	Swasiland	■	
Benelux (Belgium, Netherlands, Luxembourg)	■	■	Haiti	■		Mexico	■	■	Sweden	■	■
Benin	■		Honduras	■	■	Moldavia	■	■	Switzerland	■	■
Bolivia	■		Djibouti	■		Monte Negro	■	■	Syria	■	■
Bosnia and Herzegovina	■	■	Ecuador	■	■	Mosambique	■	■	Tajikistan	■	
Botswana	■	■	El Salvador	■		Namibia	■	■	Tanzania	■	■
Brazil	■		Egypt	■	■	Nicaragua	■		Togo	■	
Bulgaria	■	■	Eritrea	■		Niger	■		Trinidad and Tobago	■	
Burkina Faso	■		Estonia	■	■	Nigeria	■	■	Tunisia	■	■
Burundi	■		Ethiopia	■	■	Norway	■	■	Turkey	■	■
Cameroon	■		Finland	■	■	Oman	■	■	Uganda	■	
Cape Verde	■		France	■	■	Pakistan	■	■	UK/Ireland	■	■
Central African Rep.	■		Hungary	■	■	Palestine	■	■	Ukraine	■	■
Chad	■		Iceland	■		Panama	■		United Arab Emirates	■	■
Chile	■		Iran	■	■	Paraguay	■		Uruguay	■	
Comoros	■		Iraq	■	■	Peru	■	■	Uzbekistan/	■	■
Congo	■		Israel	■	■	Poland	■	■	Turkmenistan	■	
Colombia	■		Italy	■	■	Portugal	■	■	Vatican City	■	
Costa Rica	■		Jamaica	■		Qatar	■	■	Venezuela	■	■
Côte d'Ivoire	■		Jordan	■	■	Romania	■	■	Yemen	■	■
Croatia	■	■	Kazakhstan/	■	■	Rwanda	■		Zambia	■	
Czechia	■	■	Kirgistan	■		Russia	■	■	Zimbabwe	■	■
Cuba	■		Kenya	■	■	Saint Kitts and Nevis	■				
Cyprus	■		Kosovo	■	■	Saint Lucia	■				
			Kuwait	■	■	Saint Vincenta and the Grenadines	■				
			Latvia	■	■	San Marino	■				

Product Reference	Region 1 = WEST-MEA	Region 2 = CIS	Region 3 = EASTIC	Region 4 = LATAM	Region 5 = EMEA
66140XNL-HCB	4052899993013	4052899993037	4052899993051	-	-
66240XNL-HCB	4052899992894	4052899992917	4052899992931	-	-
66340XNL-HCB	4052899993099	4052899993112	4052899993136	-	-
66440XNL-HCB	4052899993174	4052899993198	4052899993211	-	-
66140CBI-HCB	4052899431577	4052899431621	4052899431645	-	-
66240CBI-HCB	4052899431683	4052899431706	4052899431720	-	-
66340CBI-HCB	4052899431768	4052899431782	4052899431812	-	-
66440CBI-HCB	4052899431850	4052899431874	4052899431898	-	-
66140ULT-HCB	4052899429598	4052899429611	4052899429635	-	-
66240ULT-HCB	4052899429659	4052899429673	4052899429697	-	-

Product Reference	■ Region 1 = WEST-MEA	■ Region 2 = CIS	■ Region 3 = EASTIC	■ Region 4 = LATAM	■ Region 5 = EMEA
66340ULT-HCB	4052899429710	4052899429734	4052899429758	-	-
66440ULT-HCB	4052899429772	4052899429796	4052899429819	-	-
66140CBB-HCB	4052899439184	4052899439207	4052899439221	-	-
66240CBB-HCB	4052899441026	4052899441040	4052899441064	-	-
66340CBB-HCB	4052899527560	4052899527584	-	-	-
66440CBB-HCB	4052899527522	4052899527546	-	-	-
64150NL-01B	4052899990920	4052899990944	4052899990968	4052899990906	-
64150NL-HCB	4052899991477	4052899991491	4052899991514	4052899991453	-
64151NL-HCB	4052899991576	4052899991590	4052899991613	4052899991552	-
64193NL-01B	4052899991088	4052899991101	4052899991125	4052899991064	-
64193NL-HCB	4052899991675	4052899991699	4052899991712	4052899991651	-
64210NL-01B	4052899991163	4052899991187	4052899991200	4052899991149	-
64210NL-HCB	4052899991774	4052899991798	4052899991811	4052899991750	-
64212NL-HCB	4052899991972	4052899991996	4052899992016	4052899991958	-
64211NL-01B	4052899991248	4052899991262	4052899991286	4052899991224	-
64211NL-HCB	4052899991873	4052899991897	4052899991910	4052899991859	-
9005NL-HCB	4052899992054	4052899992078	4052899992092	4052899992030	-
9006NL-HCB	4052899992153	4052899992177	4052899992191	4052899992139	-
64150NBS-01B	4052899992399	4052899992412	4052899992436	-	-
64150NBS-HCB	4052899992252	4052899992276	4052899992290	4052899992238	-
64193NBS-01B	4052899992450	4052899992474	4052899992498	-	-
64193NBS-HCB	4052899992337	4052899992351	4052899992375	4052899992313	-
64210NBS-01B	4052899992511	4052899992535	4052899992559	-	-
64210NBS-HCB	4052899992719	4052899992733	4052899992757	4052899992696	-
64211NBS-HCB	4052899992818	4052899992832	4052899992856	4052899992795	-
64150CBI-01B	4008321655424	4052899411418	4052899411432	4052899411395	-
64150CBI-HCB	4008321650719	4052899412880	4052899412965	4052899412804	-
64193CBI-01B	4008321651280	4052899410794	4052899410817	4052899410718	-
64193CBI-HCB	4008321650733	4052899413061	4052899413108	-	-
64210CBI-01B	4008321651563	4052899410831	4052899410855	-	-
64210CBI-HCB	4008321650757	4052899413047	4052899413085	-	-
64212CBI-HCB	4052899931077	4052899412903	4052899412989	4052899412828	-
64211CBI-HCB	4008321650771	4052899412927	4052899413009	4052899412842	-
64176CBI-HCB	4052899982208	4052899982192	4052899982185	-	-
64219CBI-HCB	4052899268357	4052899412941	4052899413023	4052899412866	-
9005CBI-HCB	4008321660282	4052899413641	4052899413726	4052899413566	-
9006CBI-HCB	4008321660305	4052899413665	4052899413740	4052899413580	-
2825HCBI-02B	4008321650870	4052899418646	4052899418660	4052899418622	-
2827DC-02B	4008321972750	4052899417939	4052899417953	4052899417915	-
7507DC-02B	4008321972774	4052899417991	4052899418011	4052899417977	-
7507LDA-02B	-	4052899418707	-	4052899418684	-
7508LDR-01B	4008321376848	4052899418516	4052899418530	4052899418493	-
7538LDR-01B	4008321376862	4052899418578	4052899418592	4052899418554	-
64150ULT-01B	4008321416100	4052899412156	4052899412170	-	-
64150ULT-HCB	4008321416162	4052899425163	4052899425187	4052899987043	-
64193ULT-01B	4008321416124	4052899425125	4052899425149	-	-
64193ULT-HCB	4008321416186	4052899425200	4052899425224	4052899513198	-
64210ULT-01B	4052899436534	4052899436152	4052899436237	-	-
64210ULT-HCB	4052899436558	4052899436213	4052899436251	4052899513211	-
64211ULT-01B	4052899436473	4052899436114	4052899436176	-	-
64211ULT-HCB	4052899436510	4052899436138	4052899436190	-	-
7506ULT-02B	4008321415141	4052899419469	4052899419483	-	-
7507ULT-02B	4008321415165	4052899419506	4052899419520	-	-
7528ULT-02B	4008321415288	4052899419582	4052899419605	-	-
2825ULT-02B	4008321415189	4052899419322	4052899419346	-	-
5007ULT-02B	4008321415202	4052899419308	4052899419384	-	-

Product Reference	■ Region 1 = WEST-MEA	■ Region 2 = CIS	■ Region 3 = EASTIC	■ Region 4 = LATAM	■ Region 5 = EMEA
5008ULT-02B	4008321415226	4052899419421	4052899419445	-	-
6418ULT-02B	4008321415240	4052899419629	4052899419643	-	-
64132ULT-02B	4008321415325	4052899419667	4052899419681	-	-
64150-01B	-	-	-	4052899412026	4050300925264
64151-01B	-	-	-	4052899412040	4050300925349
64193-01B	-	-	-	4052899411869	4050300925127
64210-01B	-	-	-	4052899411821	4050300925202
64210-01B	-	-	-	4052899408173	4050300925202
64212-01B	-	-	-	4052899411906	4052899262478
64211-01B	-	-	-	4052899411920	4008321171252
9005-01B	-	-	-	4052899408562	4008321171214
9006-01B	-	-	-	4052899408975	4008321171238
64183-01B	-	-	-	4052899411944	4050300925400
7506-02B	-	-	-	4052899402034	4050300925448
7507-02B	-	-	-	4052899531178	4050300925462
7225-02B	-	-	-	4052899402119	4050300925547
7528-02B	-	-	-	4052899402171	4050300925523
3893-02B	-	-	-	4052899407381	4050300647609
2821-02B	-	-	-	4052899418813	4050300925745
2825-02B	-	-	-	4052899418837	4050300925684
2827NA-02B	-	-	-	4052899570870	4052899570894
921-02B	-	-	-	4052899406933	4008321349507
7505-02B	-	-	-	4052899417878	4052899324565
7515-02B	-	-	-	4052899417892	4052899324589
2721-02B	-	-	-	4052899418790	4050300925769
2722-02B	-	-	-	4052899407251	4050300925783
5007-02B	-	-	-	4052899407015	4050300925585
5008-02B	-	-	-	4052899407176	4050300925608
6411-02B	-	-	-	4052899418936	4050300925646
64111-02B	-	-	-	-	4050300647258
6418-02B	-	-	-	4052899418950	4050300925622
6438-02B	-	-	-	-	4008321185389
64193NR1-01B	4052899929654	4052899411227	4052899411104	4052899411166	-
64210NR1-01B	4052899929593	4052899411203	4052899411081	4052899411142	-
64212NR1-01B	4052899389403	4052899451285	4052899451308	-	-
64211NR1-01B	4052899253728	4052899411241	4052899411128	4052899411180	-
64185NR9-01B	4052899253452	4052899408302	4052899408326	-	-
64193NR5-01B	4052899929524	4052899411289	4052899411340	-	-
64210NR5-01B	4052899929470	4052899411265	4052899411326	-	-
64211NR5-01B	4052899253742	4052899411302	4052899411364	-	-
64185NR5-01B	4052899929425	4052899984318	4052899984332	-	-
64193XR-01B	4052899253681	4052899412385	4052899412460	4052899412224	-
64210XR-01B	4052899253704	4052899412309	4052899412446	4052899412200	-
64211XR-01B	4052899936591	4052899412422	4052899412507	4052899412262	-
64212XR-01B	4052899253667	4052899412408	4052899412484	4052899412248	-
64185XR-01B	4052899253490	4052899408371	4052899408395	4052899408357	-
64327XR-01B	4052899936607	4052899409613	4052899409637	4052899409590	-
64327-01B	-	-	-	4052899409576	4052899929692
64185-01B	-	-	-	4052899408418	4052899253513
64155TSP-HCB	4008321784209	4052899413931	4052899414037	4052899413832	-
64156TSP-01B	4052899481930	4052899481916	4052899481893	4052899481954	-
64156TSP-HCB	4008321784292	4052899413955	4052899414051	4052899413856	-
64196TSP-HCB	4008321785077	4052899413979	4052899414075	4052899413870	-
64215TSP-HCB	4008321785145	4052899413917	4052899414013	4052899413818	-
64216TSP-HCB	4052899904644	4052899413993	4052899414099	4052899413894	-
3930TSP-02B	4008321174055	-	-	-	-

Product Reference	■ Region 1 = WEST-MEA	■ Region 2 = CIS	■ Region 3 = EASTIC	■ Region 4 = LATAM	■ Region 5 = EMEA
64155-01B	-	-	-	4052899412101	4050300925844
64156-01B	-	-	-	4052899412125	4050300565811
64196-01B	-	-	-	4052899411883	4050300925868
64215-01B	-	-	-	4052899411845	4050300925882
7511-02B	-	-	-	-	4050300925929
7537-02B	-	-	-	4052899402232	4050300925943
5627-02B	-	-	-	4052899418882	4050300925967
5637-02B	-	-	-	-	4050300926049
3930-02B	-	-	-	-	4050300926001
2841-02B	-	-	-	4052899407275	4050300926025
2845-02B	-	-	-	4052899407329	4008321139962
6423-02B	-	-	-	-	4050300925981
62150CBB-HCB	4052899439764	4052899437678	4052899436930	4052899439009	-
62193CBB-HCB	4052899439788	4052899437654	4052899437296	4052899439023	-
62210CBB-HCB	4052899439801	4052899437692	4052899437371	4052899439047	-
62211CBB-HCB	4052899439849	4052899437715	4052899437395	4052899439085	-
62213CBB-HCB	4052899439863	4052899437739	4052899437487	4052899439108	-
69005CBB-HCB	4052899439887	4052899437753	4052899437524	4052899439122	-
69006CBB-HCB	4052899439900	4052899437777	4052899437548	4052899439146	-
1557CW-02B	4052899367975	4052899433854	4052899433878	-	-
1557R-02B	4052899368026	4052899433915	4052899433939	-	-
1557YE-02B	4052899368002	4052899433977	4052899433991	-	-
2850CW-02B	4008321657657	4052899434424	4052899434448	4052899434400	-
2850WW-02B	4008321657633	4052899434493	4052899434516	4052899434479	-
2850BL-02B	4008321875549	4052899434356	4052899434370	4052899434332	-
2855YE-02B	4008321875600	4052899434592	4052899434615	4052899434578	-
3557CW-02B	4052899368040	4052899434882	4052899434905	-	-
3557R-02B	4052899368088	4052899434943	4052899434967	-	-
3557YE-02B	4052899368064	4052899435001	4052899435025	-	-
3850WW-02B	4008321657893	4052899440531	4052899440579	4052899440517	-
3850CW-02B	4008321658111	4052899440623	4052899440661	4052899440609	-
6497WW-01B	4052899068445	4052899435452	4052899435490	4052899435414	-
6497CW-01B	4052899068469	4052899435377	4052899435391	4052899435353	-
6498WW-01B	4008321658159	4052899436015	4052899436039	4052899435995	-
6498CW-01B	4008321658173	4052899442207	4052899442221	4052899442184	-
6499WW-01B	4052899068506	4052899442276	4052899442313	4052899442252	-
6499CW-01B	4052899068483	4052899436077	4052899436091	4052899436053	-
7556CW-02B	4052899367760	4052899441484	4052899441507	-	-
7556R-02B	4052899367944	4052899441545	4052899441569	-	-
7556YE-02B	4052899367906	4052899441668	4052899441743	-	-
7557YE-02B	4052899368101	4052899441781	4052899441804	-	-
7905CW-02B	4052899513686	4052899513723	4052899513709	-	-
7905R-02B	4052899513761	4052899513808	4052899513785	-	-
7905YE-02B	4052899513587	4052899513648	4052899513617	-	-
7915CW-02B	4052899513846	4052899513884	4052899513860	-	-
7915R-02B	4052899513921	4052899513945	4052899513969	-	-
7915YE-02B	4052899514003	4052899514027	4052899514041	-	-
9213CW-02B	4052899381896	4052899443020	4052899443044	-	-
9213R-02B	4052899381933	4052899443082	4052899443105	-	-
2824WW-02B	4008321875624	4052899434288	4052899434301	4052899434264	-
2824CW-02B	4008321875648	4052899434219	4052899434233	4052899434189	-
3924CW-02B	4008321875747	4052899440739	4052899440753	4052899440715	-
3924WW-02B	4008321875723	4052899440845	4052899440869	4052899440807	-
1458CW-02B	4052899519763	4052899519800	4052899519787	-	-
1458R-02B	4052899519862	4052899519909	4052899519886	-	-
1458YE-02B	4052899358034	4052899434110	4052899434134	-	-

Product Reference	■ Region 1 = WEST-MEA	■ Region 2 = CIS	■ Region 3 = EASTIC	■ Region 4 = LATAM	■ Region 5 = EMEA
2880BL-02B	4052899359314	4052899434653	4052899434677	-	-
2880CW-02B	4052899067820	4052899434707	4052899434721	-	-
2880YE-02B	4052899385597	4052899434820	4052899434844	-	-
2880GR-02B	4052899385634	4052899434745	4052899434769	-	-
2880R-02B	4052899359338	4052899434783	4052899434806	-	-
3548CW-02B	4052899517585	4052899517622	4052899517608	-	-
3548R-02B	4052899517851	4062172045599	4052899517998	-	-
3548YE-02B	4052899518056	4052899518094	4052899518070	-	-
6431CW-01B	4052899358072	4052899441286	4052899441309	4052899414792	-
6431BL-01B	4052899358133	4052899441248	4052899441262	-	-
6436CW-01B	4052899358096	4052899445567	4052899445581	4052899414778	-
6436BL-01B	4052899358157	4052899441323	4052899441347	-	-
6441CW-01B	4052899358119	4052899441422	4052899441446	4052899414815	-
6441BL-01B	4052899358171	4052899441378	4052899441408	-	-
7458CW-02B	4052899520837	4052899520875	4052899520851	-	-
7458R-02B	4052899520936	4052899520974	4052899520950	-	-
7458YE-02B	4052899521056	4052899521216	4052899521070	-	-
7459YE-02B	4052899521131	4052899521179	4052899521155	-	-
7706CW-02B	4052899520110	4052899520158	4052899520134	-	-
7706R-02B	4052899520219	4052899520257	4052899520233	-	-
7706YE-02B	4052899520318	4052899520356	4052899520332	-	-
7716CW-02B	4052899520455	4052899520493	4052899520479	-	-
7716R-02B	4052899520554	4052899520592	4052899520578	-	-
7716YE-02B	4052899520653	4052899520691	4052899520677	-	-
9212CW-02B	4052899474444	4052899474482	4052899474468	-	-

# LEDiving® Headlight lamps – Overview of LED forward lighting applications



LEDiving® PREMIUM SL – Exterior front lighting<sup>1)</sup>

1	2	3	4	5	6
Low beam / High beam	Daytime running light	Fog light	Front indicator	Parking/ marker light / Position light	Side indicator
≅ H4, H7, H11, HB4	≅ H7, H8/H11/H16, PS13W, PS19W, P21W, P21/5W, P27/7W, W16W, W21W, W21/5W	≅ H8/H11/H16, H10	≅ P21W, P21/5W, PY21W, P27W, P27/7W, W21W	≅ H8/H11/H16, P21/5W, P27/7W, T4W, W5W, W21W, W21/5W	≅ P21W, WY5W
P43t	PX26d	PGJ19	BA15s	PGJ19-1/2/3	BA15s
PX26d	PGJ19	PY20d	BAY15d	BAY15d	W2.1x9.5d
PGJ19-2	PG18.5d-1	PSX24W	BAU15s	W2.5x16q	
P22d	PG20-1		W2.5x16d	BA9s	
	BA15s		W2.5x16q	W2.1x9.5d	
	BAY15d		W3x16d	W3x16d	
	W2.5x16q			W3x16q	
	W2.1x9.5d				
	W3x16d				
	W3x16q				
Canbus Control Unit 50 W <sup>2)</sup>		Canbus Control Unit 21 W <sup>2)</sup>		Canbus Control Unit 5 W <sup>2)</sup>	

LED Color	Use behind red glass	Use behind clear glass	Use behind amber glass
<b>Red</b> (Tail light, Brake light)	Yes	Not recommended	Not recommended
<b>White</b> (Daytime running light, Reversing light, License plate light, Parking light)	Not recommended	Yes	Not recommended
<b>Amber</b> (Indicator light, Side marker light)	Not recommended	Yes	Yes



LEDriving® SL – Exterior front lighting<sup>1)</sup>

1	2	3	4	5	6
Low beam / High beam	Daytime running light	Fog light	Front indicator	Parking/ marker light / Position light	Side indicator
-	≅ PS13W, PS19W, P21W, P21/5W, P27/7W, W16W, W21W, W21/5W	-	≅ P21W, P21/5W, PY21W, P27W, P27/7W, W21W	≅ P21/5W, P27/7W, W5W, W21W, W21/5W	≅ P21W, W5W
-	PG18.5d-1		BA15s	BAY15d	BA15s
-	PG20-1		BAY15d	W2.5x16q	W2.1x9.5d
-	BA15s		BAU15s	W2.1x9.5d	
-	BAY15d		W2.5x16d	W3x16d	
-	W2.5x16q		W2.5x16q	W3x16q	
-	W2.1x9.5d		W3x16d		
-	W3x16d				
-	W3x16q				
Canbus Control Unit 50 W <sup>2)</sup>		Canbus Control Unit 21 W <sup>2)</sup>	Canbus Control Unit 5 W <sup>2)</sup>		

Available color options:

LEDriving® PREMIUM SL	LEDriving® SL
Cool White	Cool White
Red	Red
Amber	Amber

1) These products do not have ECE approval. This means they must not be used on public roads in any exterior application. Use on public roads leads to cancellation of operating license and loss of insurance coverage. Several countries do not allow sale and use of these products. Please contact your local distributor for information on the availability in your country.  
 2) LEDriving® CANBUS CONTROL UNIT (P.32) avoids error messages on the board computer when using LED lamps within 5 W, 21 W or 50 W applications

# LEDDriving® Signal Lamps – Overview of LED rear lighting applications



LEDDriving® PREMIUM SL – Exterior rear lighting<sup>1)</sup>

1	2	3	4	5	6	7
Rear indicator	License plate light	Brake light, Third braking light	Rear fog light	Tail light	Reversing light	Additional brake light
≅ P21W, PY21W, P27W, P27/7W, W21W	≅ C5W, P21W, P21/5W, T4W, W5W	≅ P21W, P21/5W, P27W, P27/7W, T4W, W5W, W16W, W21W, W21/5W	≅ P21W, P21/5W, P27/7W, W16W, W21W	≅ P21W, P21/5W, P27/7W, T4W, W5W, W16W, W21W, W21/5W	≅ P21W, P27/7W, W16W, W21W	≅ P21W, P21/5W, P27/7W, W5W, W16W, W21W, W21/5W
BA15s	SV8.5-8 (31, 36, 41mm)	BA15s	BA15s	BA15s	BA15s	BA15s
BAU15s	BA15s	BAY15d	BAY15d	BAY15d	W2.5x16q	BAY15d
W2.5x16d	BAY15d	W2.5x16d	W2.5x16q	W2.5x16q	W2.1x9.5d	W2.5x16q
W2.5x16q	BA9s	W2.5x16q	W2.1x9.5d	BA9s	W3x16d	W2.1x9.5d
W2.1x9.5d	W2.1x9.5d	BA9s	W3x16d	W2.1x9.5d		W2.1x9.5d
		W2.1x9.5d		W2.1x9.5d		W3x16d
		W2.1x9.5d		W3x16d		W3x16q
		W3x16d		W3x16q		
		W3x16q				
Canbus Control Unit 21W <sup>2)</sup>			Canbus Control Unit 5W and 21W <sup>2)</sup>			

LED Color	Use behind red glass	Use behind clear glass	Use behind amber glass
<b>Red</b> (Tail light, Brake light)	Yes	Not recommended	Not recommended
<b>White</b> (Daytime running light, Reversing light, License plate light, Parking light)	Not recommended	Yes	Not recommended
<b>Amber</b> (Indicator light, Side marker light)	Not recommended	Yes	Yes





LEDriving® SL – Exterior rear lighting<sup>1)</sup>

1	2	3	4	5	6	7
Rear indicator	License plate light	Brake light, Third braking light	Rear fog light	Tail light	Reversing light	Additional brake light
≅ P21W, PY21W, P27W, P27/7W, W21W	≅ C5W, P21W, P21/5W, W5W	≅ P21W, P21/5W, P27W, P27/7W, W5W, W21W, W21/5W	≅ P21W, P21/5W, P27/7W, W16W, W21W	≅ P21W, P21/5W, P27/7W, W5W, W21W, W21/5W	≅ P21W, P27/7W, W16W, W21W	≅ P21W, P21/5W, P27/7W, W5W, W21W, W21/5W
BA15s	SV8.5-8 (31, 36, 41mm)	BA15s	BA15s	BA15s	BA15s	BA15s
BAU15s	BA15s	BAY15d	BAY15d	BAY15d	W2.5x16q	BAY15d
W2.5x16d	BAY15d	W2.5x16q	W2.5x16q	W2.5x16q	W2.1x9.5d	W2.5x16q
W2.5x16q	W2.1x9.5d	W2.5x16q	W2.1x9.5d	W2.1x9.5d	W3x16d	W2.1x9.5d
W3x16d		W2.1x9.5d	W3x16d	W3x16d		W3x16d
		W3x16d		W3x16q		W3x16q
		W3x16q				
Canbus Control Unit 21W <sup>2)</sup>			Canbus Control Unit 5W and 21W <sup>2)</sup>			

Available color options:

LEDriving® PREMIUM SL	LEDriving® SL
Cool White	Cool White
Red	Red
Amber	Amber

1) These products do not have ECE approval. This means they must not be used on public roads in any exterior application. Use on public roads leads to cancellation of operating license and loss of insurance coverage. Several countries do not allow sale and use of these products. Please contact your local distributor for information on the availability in your country.  
 2) LEDriving® CANBUS CONTROL UNIT (P.32) avoids error messages on the board computer when using LED lamps within 5 W, 21 W or 50 W applications

# LEDiving® Interior Lamps – Overview of LED interior lighting applications

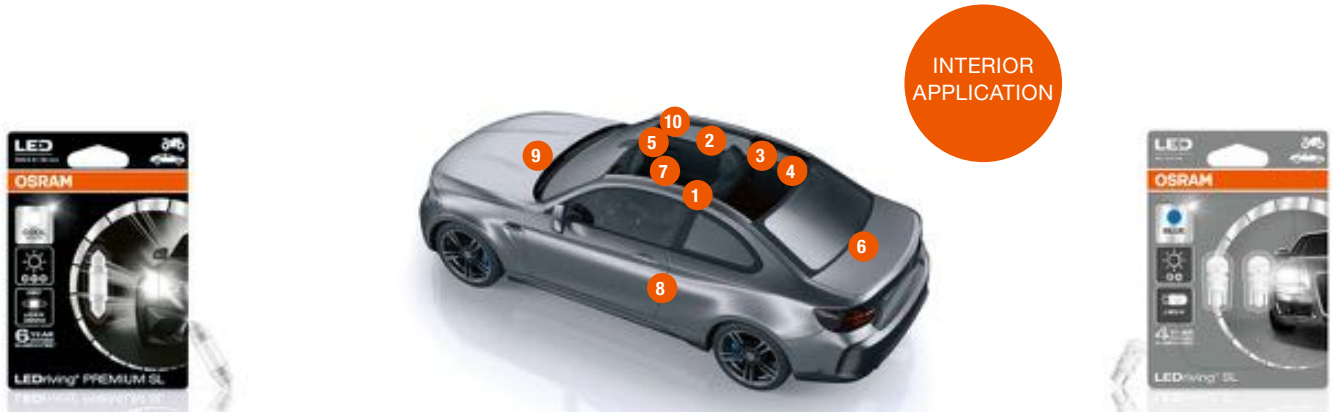

INTERIOR APPLICATION

LEDiving® PREMIUM SL – Interior lighting <sup>1)</sup>									
1	2	3	4	5	6	7	8	9	10
Dome light front	Reading light front	Dome light behind	Reading light behind	Glovebox light	Trunk light	Legroom light	Door/ Side light	Engine compartment light	Make-up mirror/visor light
≅ C5W, W5W, T4W				≅ C5W, W5W, WY5W, T4W		≅ C5W, W5W, WY5W, T4W			≅ C5W, W5W, T4W
W2.1x9.5d	W2.1x9.5d	W2.1x9.5d	W2.1x9.5d	W2.1x9.5d	W2.1x9.5d	W2.1x9.5d	W2.1x9.5d	W2.1x9.5d	W2.1x9.5d
SV8.5-8 (31, 36, 41mm)	SV8.5-8 (31, 36, 41mm)	SV8.5-8 (31, 36, 41mm)	SV8.5-8 (31, 36, 41mm)	SV8.5-8 (31, 36, 41mm)	SV8.5-8 (31, 36, 41mm)	SV8.5-8 (31, 36, 41mm)	SV8.5-8 (31, 36, 41mm)	SV8.5-8 (31, 36, 41mm)	SV8.5-8 (31, 36, 41mm)
BA9s	BA9s	BA9s	BA9s	BA9s	BA9s	BA9s	BA9s	BA9s	BA9s

LEDiving® SL – Interior lighting <sup>1)</sup>									
≅ C5W, W5W, T4W				≅ C5W, W5W, WY5W, T4W		≅ C5W, W5W, WY5W			≅ C5W, W5W
W2.1x9.5d	W2.1x9.5d	W2.1x9.5d	W2.1x9.5d	W2.1x9.5d	W2.1x9.5d	W2.1x9.5d	W2.1x9.5d	W2.1x9.5d	W2.1x9.5d
SV8.5-8 (31, 36, 41mm)	SV8.5-8 (31, 36, 41mm)	SV8.5-8 (31, 36, 41mm)	SV8.5-8 (31, 36, 41mm)	SV8.5-8 (31, 36, 41mm)	SV8.5-8 (31, 36, 41mm)	SV8.5-8 (31, 36, 41mm)	SV8.5-8 (31, 36, 41mm)	SV8.5-8 (31, 36, 41mm)	SV8.5-8 (31, 36, 41mm)

Canbus Control Unit 5W 

Available color options:

LEDiving® PREMIUM SL		LEDiving® SL		
Cool White	Blue	Cool White	Green	Red
Warm White	Amber	Blue	Amber	

1) These products do not have ECE approval. This means they must not be used on public roads in any exterior application. Use on public roads leads to cancellation of operating license and loss of insurance coverage. Several countries do not allow sale and use of these products. Please contact your local distributor for information on the availability in your country.

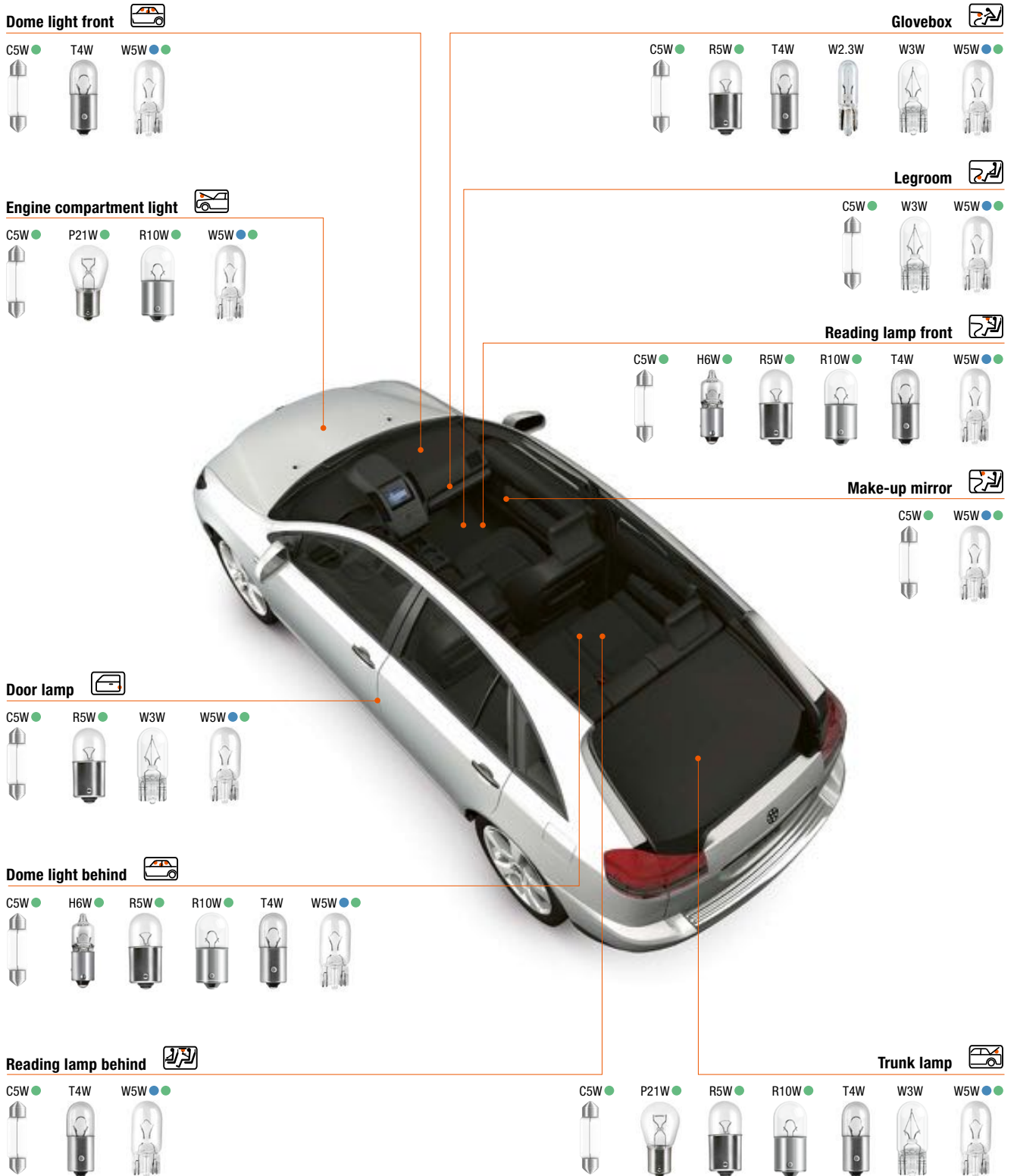

UPGRADE

**HALOGEN LIGHTING**

- **COOL BLUE® INTENSE (page 54)**  
— Bluish-white light for xenon look
- **ULTRA LIFE (page 58)**  
— 4-year guarantee<sup>1)</sup>

1) 4th year with online product registration. Refer to [www.osram.com/am-guarantee](http://www.osram.com/am-guarantee) for precise conditions and registration

**Low beam / High beam** 

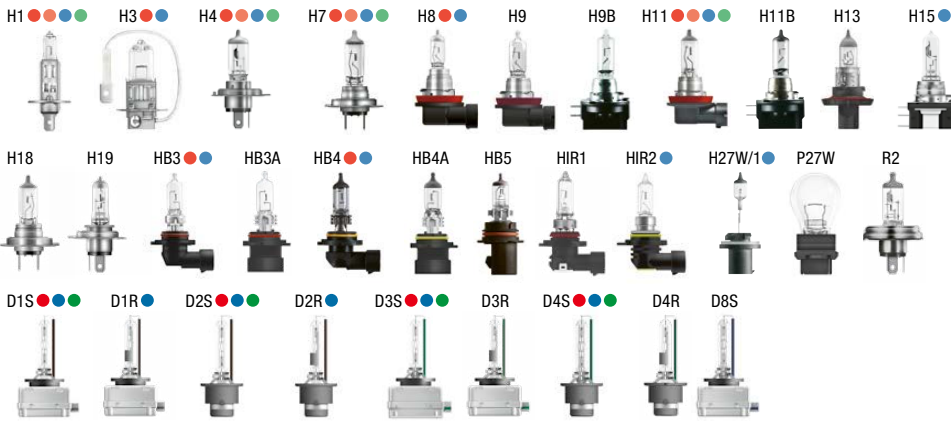

**Fog light** 



**Side indicator** 



**Front indicator** 



**Daytime running light** 



**Parking/marker light** 



**UPGRADE**

**HALOGEN LIGHTING**

- **NIGHT BREAKER® LASER (page 50)**
  - Up to 150% more brightness<sup>1)</sup>
- **NIGHT BREAKER® SILVER (page 52)**
  - Up to 100% more brightness<sup>1)</sup>
- **COOL BLUE® INTENSE (page 54)**
  - Bluish-white light for xenon look

- **DIADEM® CHROME (page 56)**
  - Only amber when ON
- **DIADEM® (page 56)**
  - Red or amber when ON
- **ULTRA LIFE (page 58)**
  - 4-year guarantee<sup>2)</sup>

**Brake light / Third braking light**



**Rear indicator**



**Tail light**



**License plate light**



**Reversing light**



**Rear fog light**



**XENON LIGHTING**

- **XENARC® NIGHT BREAKER® LASER (page 40)**  
— Up to 200% more brightness<sup>3)</sup>
- **XENARC® COOL BLUE® INTENSE (page 42)**  
— Extra blue light<sup>4)</sup>
- **XENARC® ULTRA LIFE (page 44)**  
— 10-year guarantee<sup>5)</sup>

- 1) Compared to minimum ECE R112 requirements
- 2) 4th year with online product registration. Refer to [www.osram.com/am-guarantee](http://www.osram.com/am-guarantee) for precise conditions and registration
- 3) Compared to minimum ECE R98 requirements
- 4) From a special filling system instead of conventional coating
- 5) With online product registration. Refer to [www.osram.com/am-guarantee](http://www.osram.com/am-guarantee) for precise conditions and registration

**Parking/marker light** 



**Side indicator** 



**Front indicator** 



**Side-marker light** 



**License plate light** 



**Low beam / High beam** 

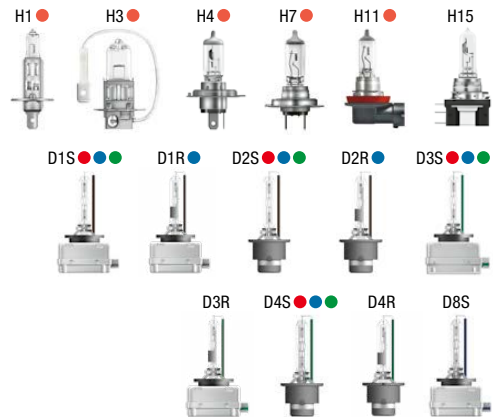

**Daytime running light** 



**Fog light** 

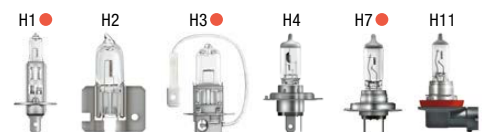

**Parking/marker light** 



**Indicator/brake/rear fog/tail and reversing light**



UPGRADE

**HALOGEN LIGHTING**

- **TRUCKSTAR® PRO** (page 68)
- Up to 100% more brightness<sup>1)</sup>

1) Compared to minimum ECE R112 requirements  
 2) Compared to minimum ECE R98 requirements  
 3) From a special filling system instead of conventional coating  
 4) With online product registration. Refer to [www.osram.com/am-guarantee](http://www.osram.com/am-guarantee) for precise conditions and registration

**XENON LIGHTING**

- **XENARC® NIGHT BREAKER® LASER** (page 40)
- Up to 200% more brightness<sup>2)</sup>
- **XENARC® COOL BLUE® INTENSE** (page 42)
- Extra blue light<sup>3)</sup>
- **XENARC® ULTRA LIFE** (page 44)
- 10-year guarantee<sup>4)</sup>

**Low beam / High beam / Fog light**

H1 ●	H3	H4 ●●●●	H7 ●●●●	H8 ●●	H11 ●●●●	HS1 ●●●●	HB3
HB4	HIR2	S1	S2 ●	R2			
D1S	D1R	D2S					

**Reversing/brake/rear fog light**

P21W ●	P21/5W ●	P27/7W
PR21W ●	PR21/5W ●	R5W ●
R10W	T4W	W5W ●●
WY5W ●	W16W	W21/5W

**Front indicator / parking/marker light**

H6W ●	H21W	P21W ●	P21/5W ●	PY21W ●●			
R5W ●	R10W ●	RY10W	T4W				
W3W	W5W ●●	WY5W ●	W16W				
W21W	W21/5W	WY21W					

**Rear indicator**

H6W ●	P21W ●	P21/5W ●
PY21W ●●	R10W ●	RY10W
W5W ●●	WY5W ●	W16W
WY16W	W21W	WY21W

**License plate light**

C5W ●	H6W ●	P21W ●	P21/5W ●	R5W ●	R10W ●	T4W	W3W	W5W ●●

**HALOGEN LIGHTING**

- **NIGHT RACER® 110 (page 76)**  
— Up to 110% more brightness<sup>1)</sup>
- **NIGHT RACER® 90 (page 76)**  
— Up to 90% more brightness<sup>1)</sup>
- **NIGHT RACER® 50 (page 78)**  
— Up to 50% more brightness<sup>1)</sup>

- **X-RACER® (page 80)**  
— Bluish-white light for xenon look
- **DIADEM® CHROME (page 56)**  
— Only amber when ON
- **DIADEM® (page 56)**  
— Red or amber when ON

- **ULTRA LIFE (page 58)**  
— 4-year guarantee<sup>2)</sup>

1) Compared to minimum ECE R112 requirements  
2) 4th year with online product registration. Refer to [www.osram.com/am-guarantee](http://www.osram.com/am-guarantee) for precise conditions and registration

**Base stamp**

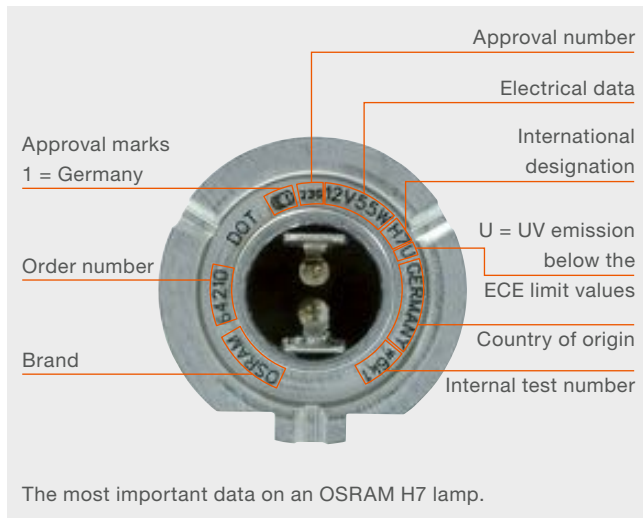

**Lamps per Product number**



**Notes on product labeling**

	Not for residential lighting		Do not dispose with household waste
	High levels of UV radiation		Switch off lights before replacing lamp
	Installation and maintenance only by qualified electricians		Ignition procedure for lamps with external igniter
	Caution: Hot		Lamp cannot be dimmed
	Hazardous voltage		Wear suitable gloves when fitting or removing
	Do not use the lamp if the glass bulb is scratched or damaged		Protect against splashes
	Wear suitable goggles when fitting or removing		Operate only in shielded luminaires
	Do not touch the glass bulb; hold the base when inserting		Pb-free

Any manipulation of our products or packaging, including but not limited to modification, reworking or restamping, is prohibited and infringes our registered trademark rights. Such modifications may impair the technical properties of our products, destroy them or cause consequential damage or injury, for which OSRAM cannot under any circumstances be held responsible. For more information on our products, go to: [www.osram.com](http://www.osram.com)



## Glossary of the most important lighting terms

### Luminous flux $\Phi$

Unit of measurement: lumen [lm]

Luminous flux  $\Phi$  is the total radiated power emitted by a light source evaluated with the spectral sensitivity of the eye and the photometric radiation equivalent  $K_m$ .

Luminous flux  $\Phi$  is the luminous intensity  $I$  emitted in the entire solid angle  $\Omega$ .

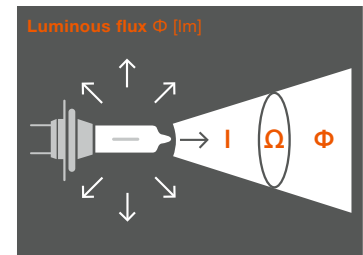

### Luminous intensity I

Unit of measurement: candela [cd]

Generally speaking, a light source emits its luminous flux  $\Phi$  in different directions and at different intensities.

Luminous intensity is the luminous flux radiated in a specific direction (solid angle  $\Omega$ ).

Polar diagram.

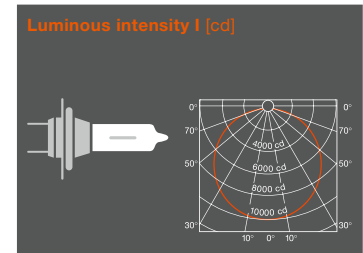

### Illuminance E

Unit of measurement: lux [lx]

Illuminance  $E$  is the ratio between the luminous flux and the area illuminated. An illuminance of 1 lx occurs when a luminous flux of 1 lm is evenly distributed over an area of 1 m<sup>2</sup>.

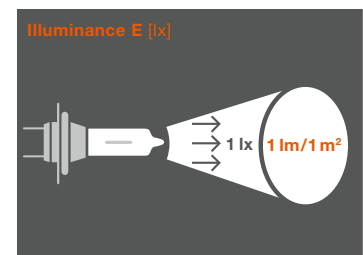

### Luminance L

Unit of measurement: candela per square meter [cd/m<sup>2</sup>]

The luminance  $L$  of a light source or an illuminated area is a measure of the impression of brightness.

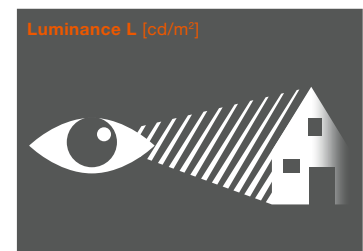

### Luminous efficacy $\eta$

Unit of measurement: lumens per watt [lm/W]

Luminous efficacy  $\eta$  indicates the efficiency with which the electrical power consumed is converted into light.

### Color temperature

Unit of measurement: Kelvin [K]





















The color temperature of a light source is defined in comparison with a "black body radiator" and plotted on what is known as the "Planckian curve." The higher the temperature of this black body radiator is, the greater the blue component in the spectrum and the smaller the red component.

### Lamp life

The  $B_3$  life-span value represents the premature failure rate of lamps. This means that 3% of all tested lamps will have failed after this number of burning hours.

The  $T_c$  lifespan value represents the failure rate of 63.2% of the lamps.

## Symbols

	Int. category label ECE
	Rated wattage in watts
	Power consumption in watts
	Voltage in volts
	Test voltage in volts
	Luminous flux in lumens
	Lifespan (h)
	Illuminance in lux
	Wavelength (λ)
	Color temperature in K
	Light color
	Information
	Base
	Fig. no.
	Set
	Width b in mm
	Height h in mm
	Length l in mm
	Shipping unit
	Single packaging

## Packaging variants

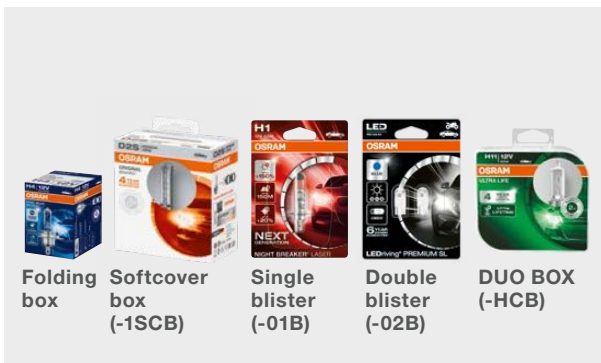

**Always up to date!**  
**Download the latest OSRAM**  
**Automotive catalog here:**  
[www.osram.com/am-catalog-digital](http://www.osram.com/am-catalog-digital)



**Key information at a glance!**  
**Download the OSRAM Automotive Portfolio**  
**for a compressed product overview**  
[www.osram.com/am-catalog-portfolio](http://www.osram.com/am-catalog-portfolio)



**Which lamps fit your vehicle?**  
**Find out with our Vehicle Lamp Finder**  
**online app:**  
[www.osram.com/vehicelamps](http://www.osram.com/vehicelamps)



**Stay up to date!**  
**Follow OSRAM Automotive on Facebook:**  
[www.facebook.com/osramautomotive](http://www.facebook.com/osramautomotive)



**Read about events, tests and technology**  
**insights on our all new OSRAM Carlightblog:**  
[www.carlightblog.com](http://www.carlightblog.com)



**OSRAM**

OSRAM is the world market leader in automotive lighting. Our customers include the world's foremost automobile manufacturers. Half of all passenger vehicles manufactured globally each year are equipped with OSRAM lights.

#### OSRAM SITES

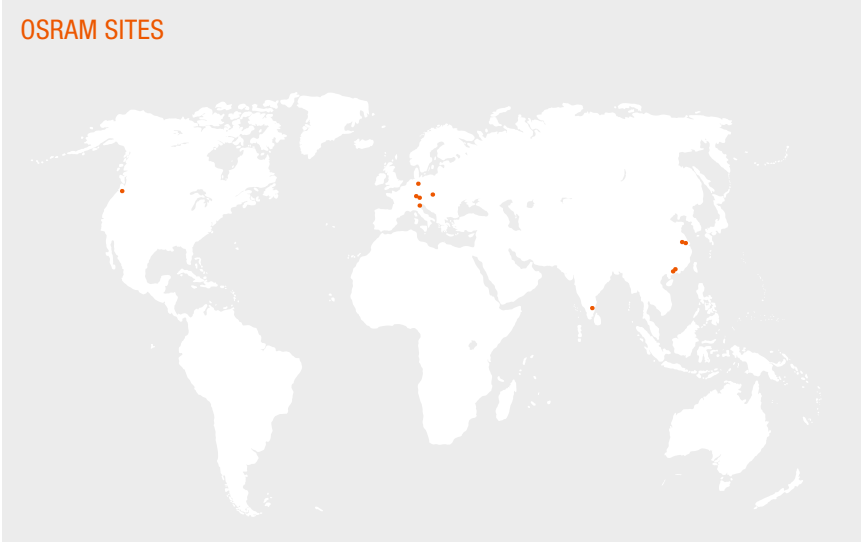

#### Light range 2019/2020 – always up-to-date

Download the pdf of our current catalog that's constantly updated. [www.osram.com/am-catalog-digital](http://www.osram.com/am-catalog-digital)



#### OSRAM GmbH

Head office:

Marcel-Breuer-Strasse 6  
80807 Munich, Germany  
Phone +49 89 6213-0  
Fax +49 89 6213-2020  
[www.osram.com](http://www.osram.com)

# OSRAM