

# OSRAM GY CS8PM1.23

## Datasheet

Published by **ams-OSRAM AG**

Tobelbader Strasse 30, 8141 Premstaetten, Austria

Phone +43 3136 500-0

[ams-osram.com](http://ams-osram.com)

© All rights reserved



OSLON® SSL 80

# GY CS8PM1.23

New, higher performing OSLON SSL family LED with well known superior robustness, high reliability, long lifetime, low thermal resistance. Perfectly addressing applications demanding for high efficiency and long lifetime requirement.

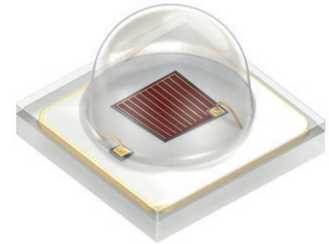

## Applications

- Entertainment
- Indoor Lighting
- Outdoor & Industrial Lighting

## Features

- Package: SMT ceramic package with silicone lens
- Typ. Radiation: 80°
- Lumen maintenance: Test results according to IESNA LM-80 available
- ESD: 8 kV acc. to ANSI/ESDA/JEDEC JS-001 (HBM, Class 3B)
- Luminous Flux: typ. 81 lm
- Luminous efficacy:: typ. 105 lm/W

---

## Ordering Information

Type	Luminous Flux <sup>1)</sup> $I_F = 350 \text{ mA}$ $\Phi_V$	Ordering Code
GY CS8PM1.23-KQKS-36	76.3 ... 97.0 lm	Q65112A0766

---

## Maximum Ratings

Parameter	Symbol		Values
Operating Temperature	$T_{op}$	min.	-40 °C
		max.	125 °C
Storage Temperature	$T_{stg}$	min.	-40 °C
		max.	125 °C
Junction Temperature	$T_j$	max.	135 °C
Forward current	$I_F$	min.	100 mA
		max.	1000 mA
Surge Current $t \leq 10 \mu s$ ; $D = 0.005$ ; $T_s = 25 \text{ °C}$	$I_{FS}$	max.	2000 mA
Reverse current <sup>2)</sup>	$I_R$	max.	200 mA
ESD withstand voltage acc. to ANSI/ESDA/JEDEC JS-001 (HBM, Class 3B)	$V_{ESD}$		8 kV

## Characteristics

$I_F = 350 \text{ mA}$ ;  $T_s = 25 \text{ °C}$

Parameter	Symbol	Values
Peak Wavelength	$\lambda_{\text{peak}}$	typ. 593 nm
Dominant Wavelength <sup>3)</sup> $I_F = 350 \text{ mA}$	$\lambda_{\text{dom}}$	min. 583 nm
		typ. 590 nm
		max. 595 nm
Spectral Bandwidth at 50% $I_{\text{rel,max}}$	$\Delta\lambda$	typ. 16 nm
Viewing angle at 50% $I_V$	$2\phi$	typ. 80 °
Forward Voltage <sup>4)</sup> $I_F = 350 \text{ mA}$	$V_F$	min. 2.00 V
		typ. 2.20 V
		max. 2.50 V
Reverse voltage <sup>2)</sup> $I_R = 20 \text{ mA}$	$V_R$	max. 1.2 V
Electrical thermal resistance junction/solderpoint with efficiency $\eta_e = 22 \%$	$R_{\text{thJS elec.}}$	typ. 4.1 K / W

## Brightness Groups

Group	Luminous Flux <sup>1)</sup> $I_F = 350 \text{ mA}$ min. $\Phi_V$	Luminous Flux <sup>1)</sup> $I_F = 350 \text{ mA}$ max. $\Phi_V$
KQ	76.3 lm	82.0 lm
KR	82.0 lm	89.2 lm
KS	89.2 lm	97.0 lm

## Wavelength Groups

Group	Dominant Wavelength <sup>3)</sup> $I_F = 350 \text{ mA}$ min. $\lambda_{\text{dom}}$	Dominant Wavelength <sup>3)</sup> $I_F = 350 \text{ mA}$ max. $\lambda_{\text{dom}}$
3	583 nm	586 nm
4	586 nm	589 nm
5	589 nm	592 nm
6	592 nm	595 nm

---

## Group Name on Label

### Example: KQ-3

Brightness	Wavelength
KQ	3

---

### Relative Spectral Emission <sup>5)</sup>

$I_{rel} = f(\lambda)$ ;  $I_F = 350 \text{ mA}$ ;  $T_S = 25 \text{ }^\circ\text{C}$

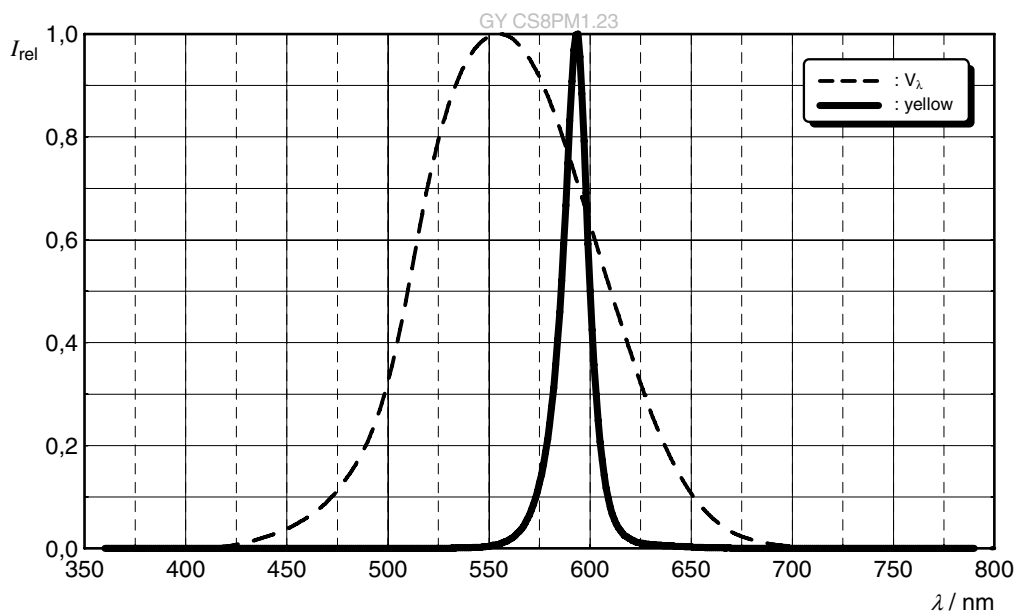

### Radiation Characteristics <sup>5)</sup>

$I_{rel} = f(\phi)$ ;  $T_S = 25 \text{ }^\circ\text{C}$

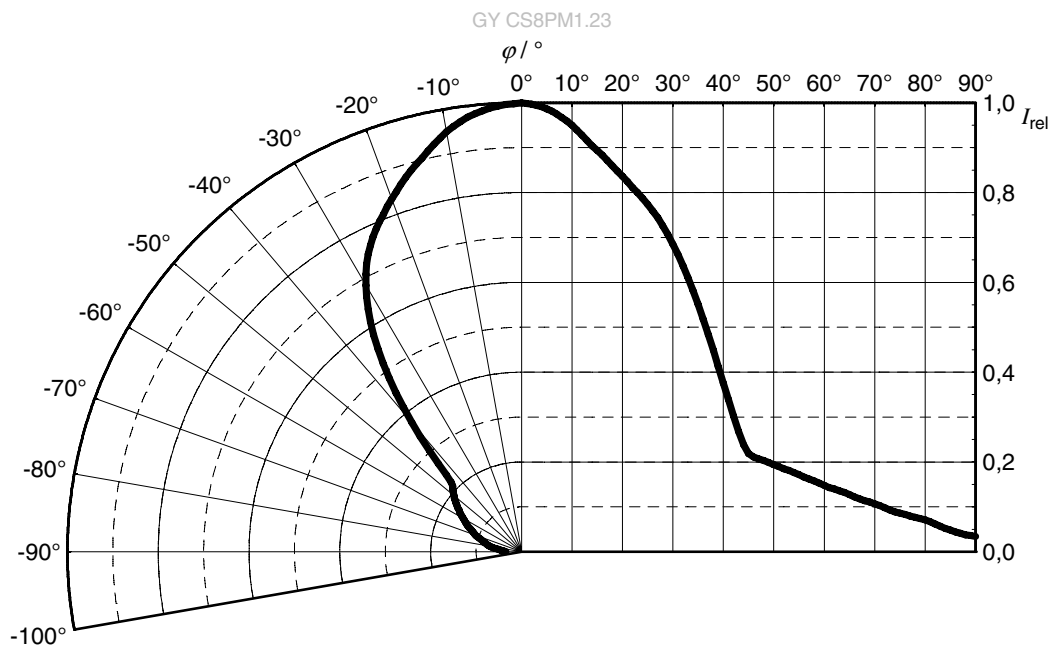



**Forward current** <sup>5)</sup>

$I_F = f(V_F); T_S = 25\text{ °C}$

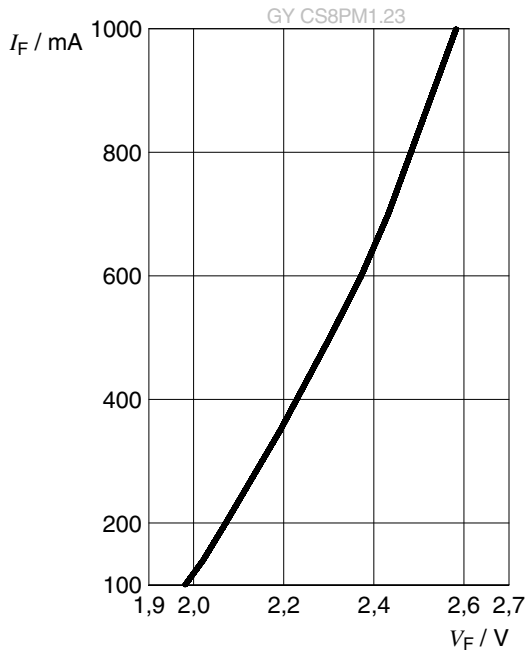

**Relative Luminous Flux** <sup>5), 6)</sup>

$\Phi_V / \Phi_V(350\text{ mA}) = f(I_F); T_S = 25\text{ °C}$

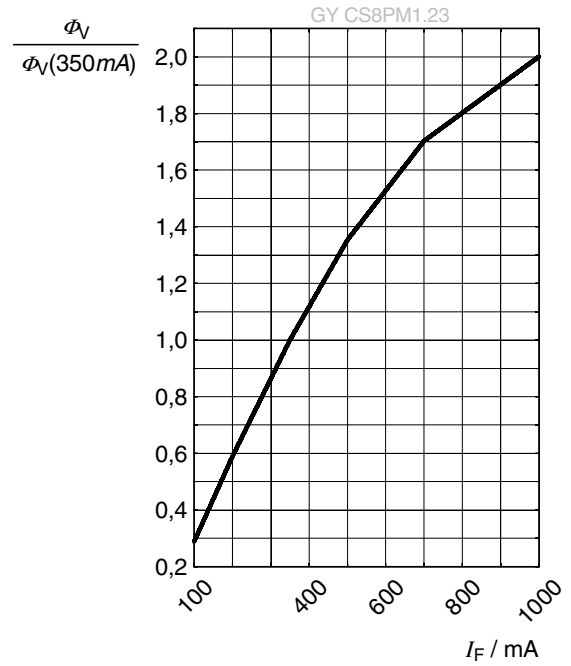

**Dominant Wavelength** <sup>5)</sup>

$\Delta\lambda_{\text{dom}} = f(I_F); T_S = 25\text{ °C}$

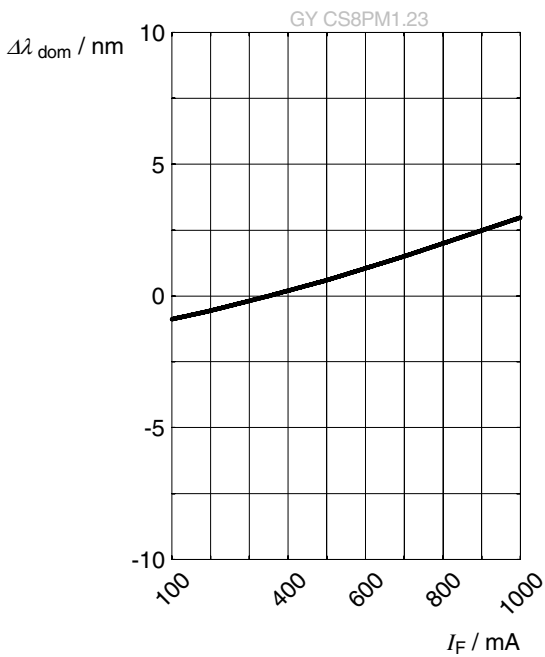

### Forward Voltage <sup>5)</sup>

$$\Delta V_F = V_F - V_F(25\text{ °C}) = f(T_j); I_F = 350\text{ mA}$$

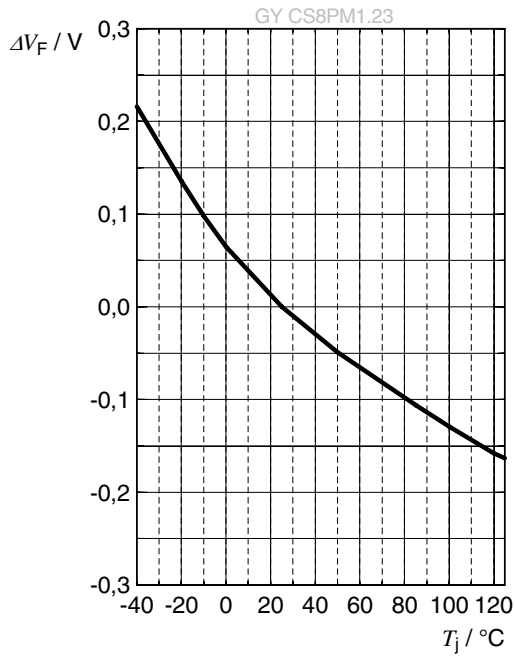

### Relative Luminous Flux <sup>5)</sup>

$$\Phi_V / \Phi_V(25\text{ °C}) = f(T_j); I_F = 350\text{ mA}$$

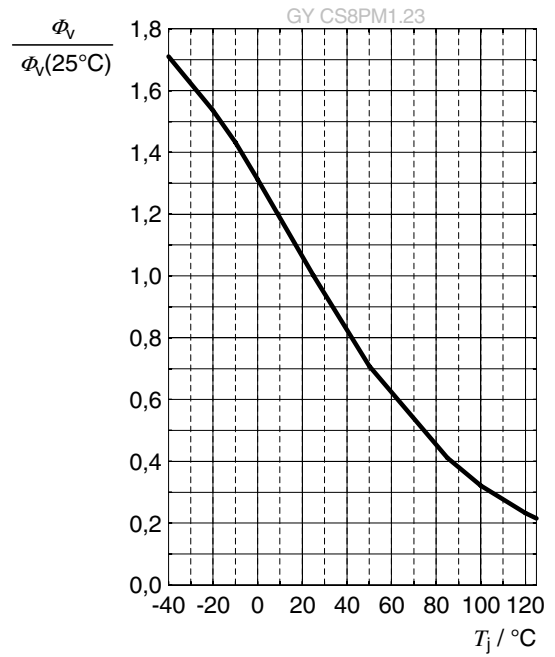

### Dominant Wavelength <sup>5)</sup>

$$\Delta \lambda_{\text{dom}} = \lambda_{\text{dom}} - \lambda_{\text{dom}}(25\text{ °C}) = f(T_j); I_F = 350\text{ mA}$$

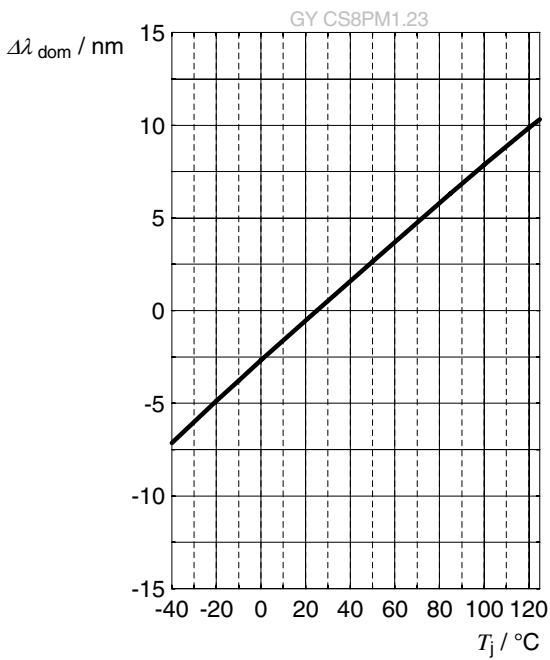

## Max. Permissible Forward Current

$$I_F = f(T)$$

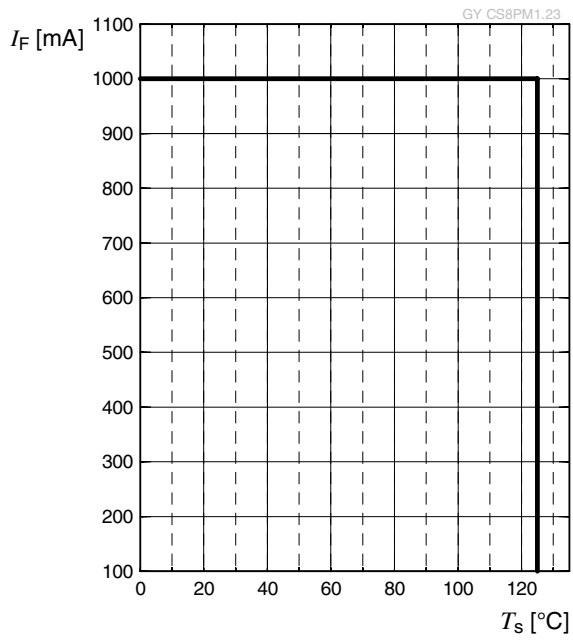

## Dimensional Drawing <sup>7)</sup>

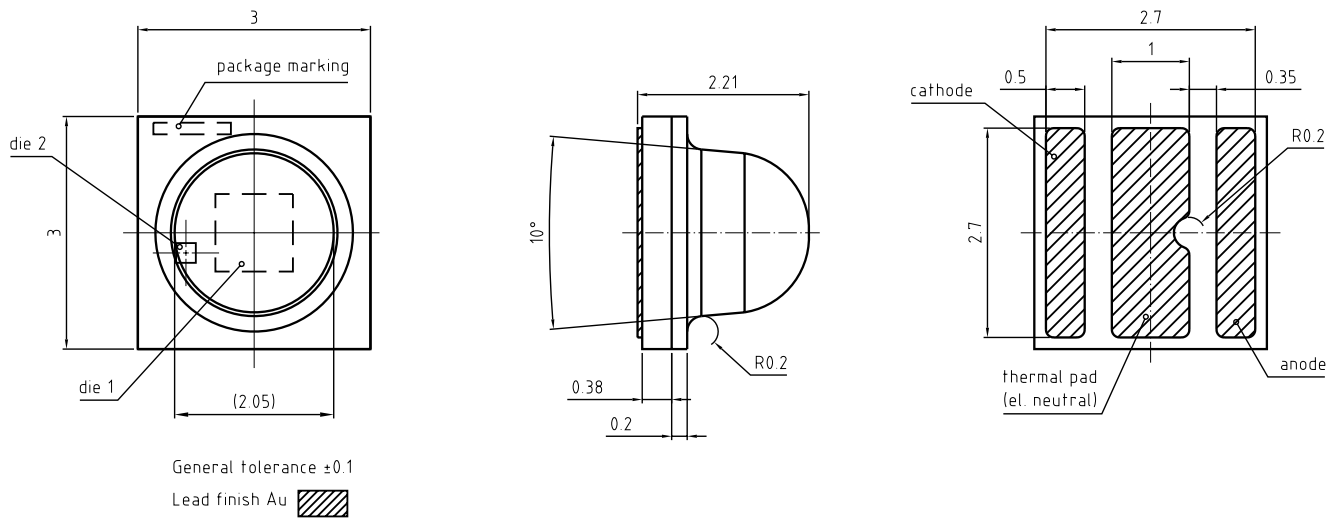

C63062-A0181-A1...-04

## Further Information:

**Approximate Weight:** 24.0 mg

**Package marking:** Anode

**ESD advice:** The device is protected by ESD device which is connected in parallel to the Chip.

## Recommended Solder Pad <sup>7)</sup>

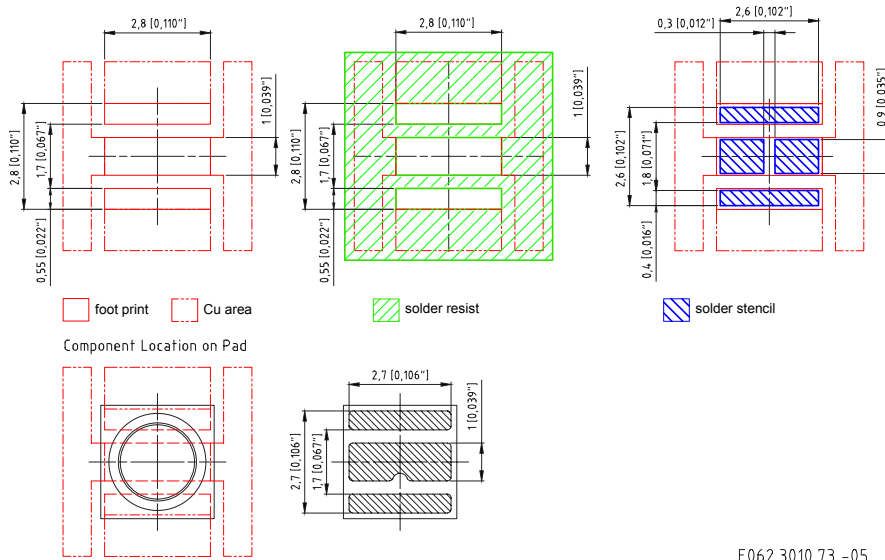

E062.3010.73 -05

For superior solder joint connectivity results we recommend soldering under standard nitrogen atmosphere. Further information can be found in our Application Note: "Handling and Processing Details for Ceramic LEDs".

## Reflow Soldering Profile

Product complies to MSL Level 2 acc. to JEDEC J-STD-020E

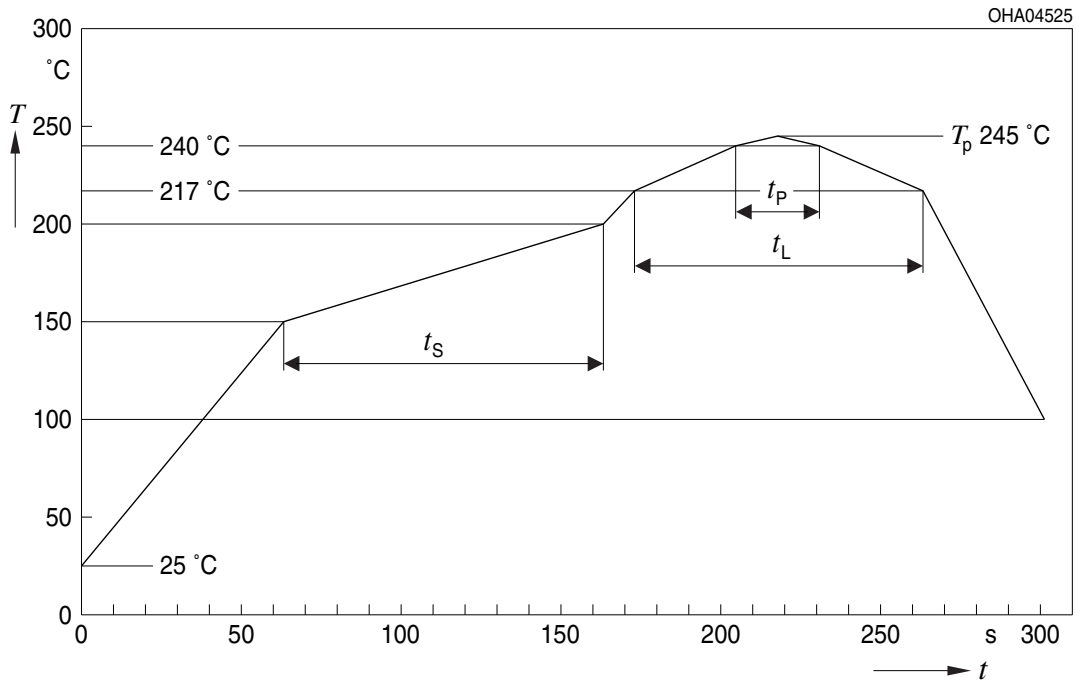

Profile Feature	Symbol	Pb-Free (SnAgCu) Assembly			Unit
		Minimum	Recommendation	Maximum	
Ramp-up rate to preheat <sup>*)</sup> 25 °C to 150 °C			2	3	K/s
Time $t_s$ $T_{Smin}$ to $T_{Smax}$	$t_s$	60	100	120	s
Ramp-up rate to peak <sup>*)</sup> $T_{Smax}$ to $T_p$			2	3	K/s
Liquidus temperature	$T_L$		217		°C
Time above liquidus temperature	$t_L$		80	100	s
Peak temperature	$T_p$		245	260	°C
Time within 5 °C of the specified peak temperature $T_p - 5$ K	$t_p$	10	20	30	s
Ramp-down rate* $T_p$ to 100 °C			3	6	K/s
Time 25 °C to $T_p$				480	s

All temperatures refer to the center of the package, measured on the top of the component

\* slope calculation  $DT/Dt$ :  $Dt$  max. 5 s; fulfillment for the whole T-range

Taping <sup>7)</sup>

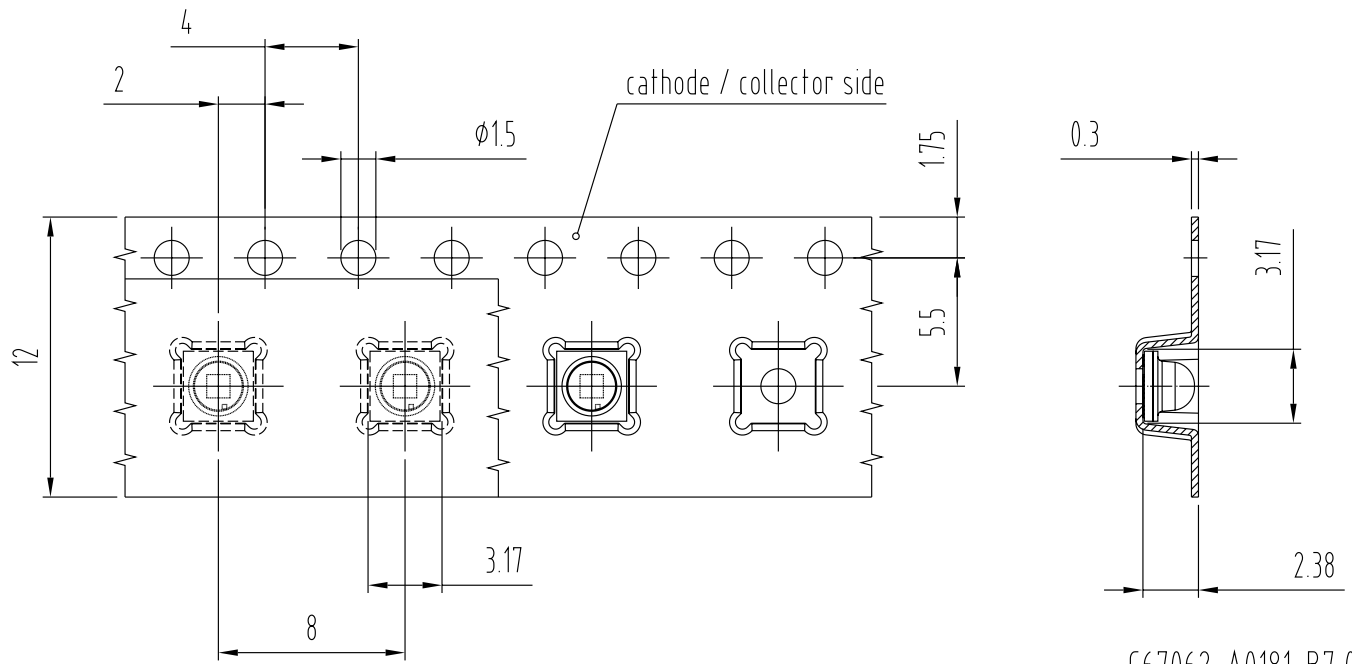

## Tape and Reel <sup>8)</sup>

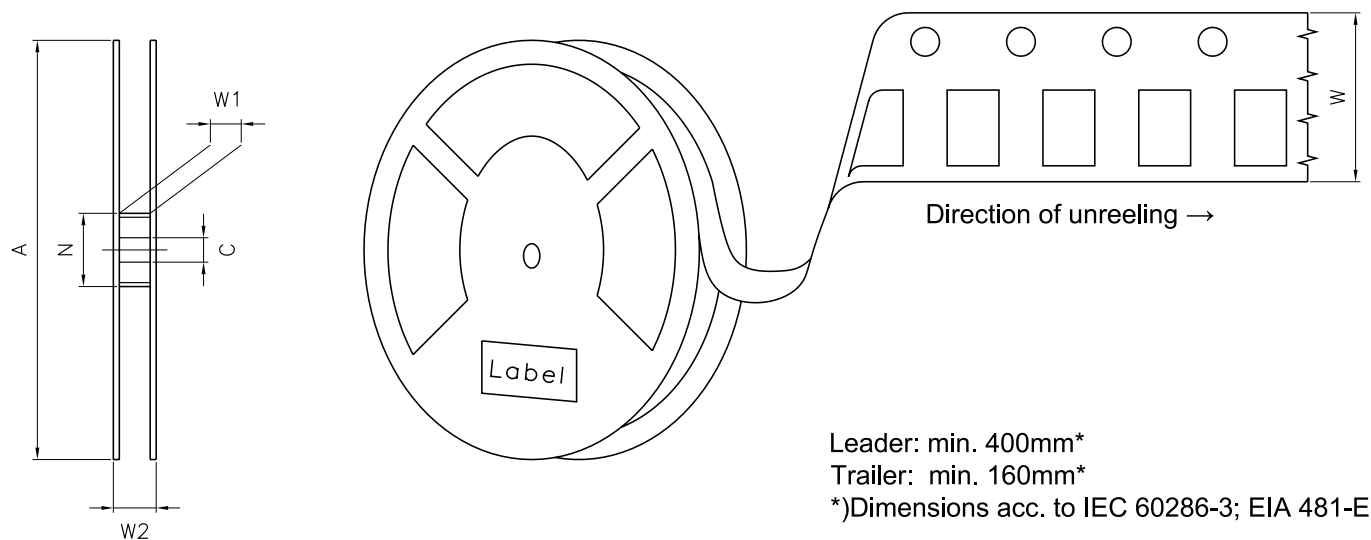

## Reel Dimensions

A	W	$N_{\min}$	$W_1$	$W_{2\max}$	Pieces per PU
180 mm	$12 + 0.3 / - 0.1$ mm	60 mm	$12.4 + 2$ mm	18.4 mm	600



**Barcode-Product-Label (BPL)**

**OSRAM** LX XXXX    BIN1: XX-XX-X-XXX-X





RoHS Compliant

(6P) BATCH NO: 1234567890 ML Temp    ST  
X    XXX °C X

(1T) LOT NO: 1234567890 (9D) D/C: 1234

Pack: RXX  
DEMY    XXX  
X\_X123\_1234.1234 X

(X) PROD NO: 123456789(Q)QTY: 9999 (G) GROUP: XX-XX-X-X

OHA04563

**Dry Packing Process and Materials <sup>7)</sup>**

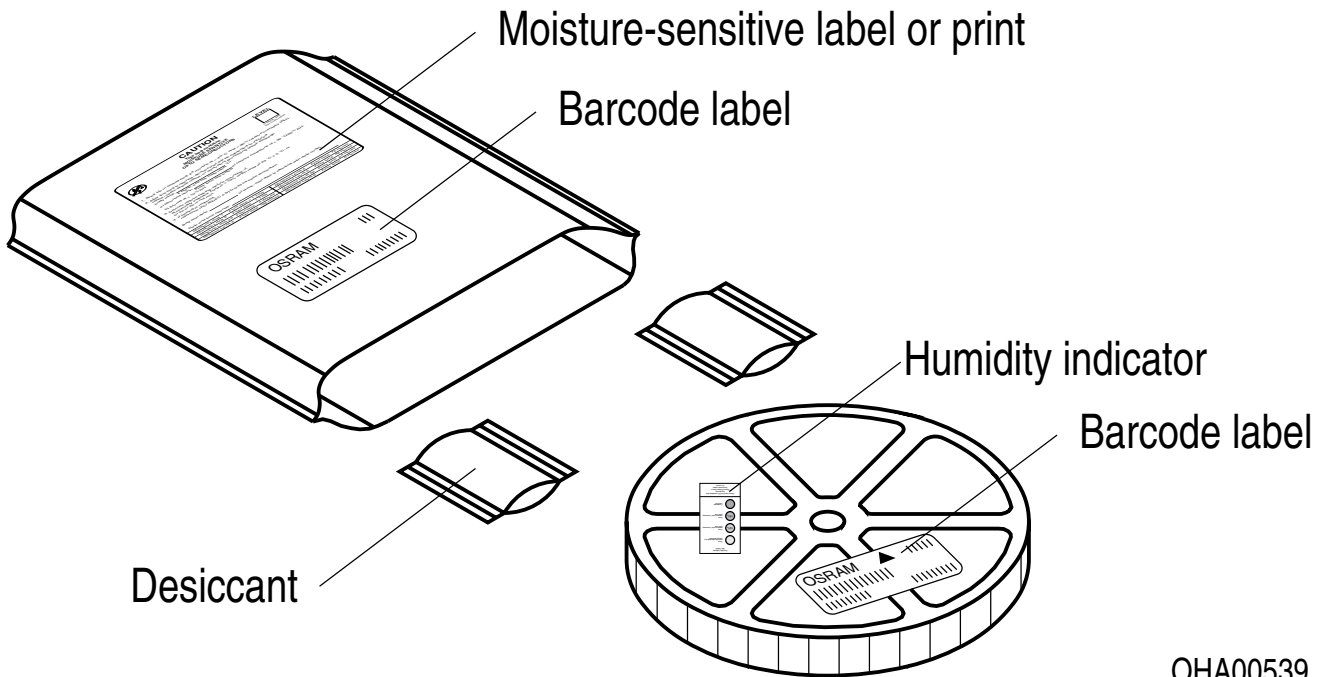

OHA00539

Moisture-sensitive product is packed in a dry bag containing desiccant and a humidity card according JEDEC-STD-033.

---

## Notes

The evaluation of eye safety occurs according to the standard IEC 62471:2006 (photo biological safety of lamps and lamp systems). Within the risk grouping system of this IEC standard, the device specified in this data sheet fall into the class **exempt group (exposure time 10000 s)**. Under real circumstances (for exposure time, conditions of the eye pupils, observation distance), it is assumed that no endangerment to the eye exists from these devices. As a matter of principle, however, it should be mentioned that intense light sources have a high secondary exposure potential due to their blinding effect. When looking at bright light sources (e.g. headlights), temporary reduction in visual acuity and afterimages can occur, leading to irritation, annoyance, visual impairment, and even accidents, depending on the situation.

Subcomponents of this device contain, in addition to other substances, metal filled materials including silver. Metal filled materials can be affected by environments that contain traces of aggressive substances. Therefore, we recommend that customers minimize device exposure to aggressive substances during storage, production, and use. Devices that showed visible discoloration when tested using the described tests above did show no performance deviations within failure limits during the stated test duration. Respective failure limits are described in the IEC60810.

This device is designed for specific/recommended applications only. Please consult OSRAM Opto Semiconductors Sales Staff in advance for detailed information on other non-recommended applications (e.g. automotive).

Change management for this component is aligned with the requirements of the lighting market.

For further application related information please visit [www.osram-os.com/appnotes](http://www.osram-os.com/appnotes)

## Disclaimer

### Attention please!

The information describes the type of component and shall not be considered as assured characteristics. Terms of delivery and rights to change design reserved. Due to technical requirements components may contain dangerous substances.

For information on the types in question please contact our Sales Organization.

If printed or downloaded, please find the latest version on our website.

### Packing

Please use the recycling operators known to you. We can also help you – get in touch with your nearest sales office. By agreement we will take packing material back, if it is sorted. You must bear the costs of transport. For packing material that is returned to us unsorted or which we are not obliged to accept, we shall have to invoice you for any costs incurred.

### Product and functional safety devices/applications or medical devices/applications

Our components are not developed, constructed or tested for the application as safety relevant component or for the application in medical devices.

Our products are not qualified at module and system level for such application.

In case buyer – or customer supplied by buyer – considers using our components in product safety devices/ applications or medical devices/applications, buyer and/or customer has to inform our local sales partner immediately and we and buyer and /or customer will analyze and coordinate the customer-specific request between us and buyer and/or customer.

---

## Glossary

- 1) **Brightness:** Brightness values are measured during a current pulse of typically 10 ms, with a tolerance of +/- 7%.
- 2) **Reverse Operation:** This product is intended to be operated applying a forward current within the specified range. Applying any continuous reverse bias or forward bias below the voltage range of light emission shall be avoided because it may cause migration which can change the electro-optical characteristics or damage the LED.
- 3) **Wavelength:** The wavelength is measured at a current pulse of typically 10 ms, with a tolerance of  $\pm 0.5$  nm.
- 4) **Forward Voltage:** The Forward voltage is measured during a current pulse duration of typically 1 ms with a tolerance of  $\pm 0.05V$  .
- 5) **Typical Values:** Due to the special conditions of the manufacturing processes of semiconductor devices, the typical data or calculated correlations of technical parameters can only reflect statistical figures. These do not necessarily correspond to the actual parameters of each single product, which could differ from the typical data and calculated correlations or the typical characteristic line. If requested, e.g. because of technical improvements, these typ. data will be changed without any further notice.
- 6) **Characteristic curve:** In the range where the line of the graph is broken, you must expect higher differences between single devices within one packing unit.
- 7) **Tolerance of Measure:** Unless otherwise noted in drawing, tolerances are specified with  $\pm 0.1$  and dimensions are specified in mm.
- 8) **Tape and Reel:** All dimensions and tolerances are specified acc. IEC 60286-3 and specified in mm.

---

## Revision History

Version	Date	Change
1.3	2020-10-23	New Layout
1.4	2020-11-18	Applications
1.5	2021-12-23	Ordering Information Brightness Groups
1.6	2023-03-22	Applications Electro - Optical Characteristics (Diagrams) New Layout

---



EU RoHS and China RoHS compliant product

此产品符合欧盟 RoHS 指令的要求；  
按照中国的相关法规和标准，  
不含有毒有害物质或元素。

**Published by ams-OSRAM AG**

Tobelbader Strasse 30, 8141 Premstaetten, Austria

Phone +43 3136 500-0

[ams-osram.com](http://ams-osram.com)

© All rights reserved

**am**  **OSRAM**